



*VOUS PROPOSE SA SELECTION DE*  
**PORTES INTERIEURES DECORATIVES**



**DESIGN**



**QUALITE**

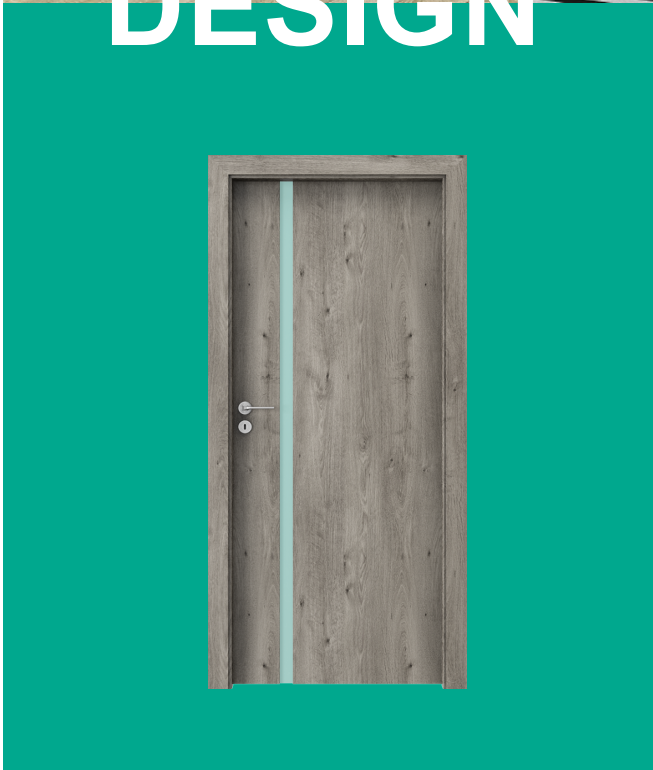

# Porte MINIMAX



Porte à recouvrement  
Ame alvéolaire  
3 fiches  
Serrure à clé ou condamnation



MINIMAX White

■ COULEUR

Décor PortaSynchro ★★★★★

White  
9003

# Porte Norwegian PINE



Porte à recouvrement  
Ame alvéolaire  
3 fiches  
Serrure à clé ou condamnation



DECOR Norwegian Pine

## COULEURS

Décor PortaSynchro ★★★★★

Norwegian  
Pine

# Porte DECOR



Porte à recouvrement  
Ame alvéolaire  
3 fiches  
Serrure à clé ou condamnation



DECOR Siberian



Un aspect bois naturel pour une ambiance chaleureuse aux teintes modernes. Ressentez le veinage du bois au toucher.

## COULEURS

Décor Portaperfect ★★★★★☆

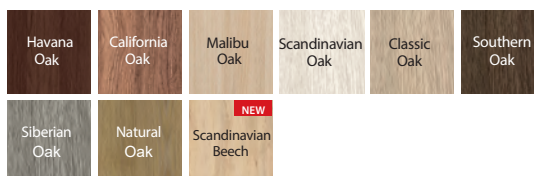

# Porte VECTOR - FORM



Porte à recouvrement  
Ame alvéolaire  
3 fiches  
Serrure à clé ou condamnation



VECTOR V



Vector T



Vector E



Vector W



Vector C



Form 3



Form 5



Form 2

## COULEUR

Laque blanc ★★★★★☆



Insert Porte Form



# Porte CPL



Porte à recouvrement  
 Arme alvéolaire  
 3 fiches  
 Serrure à clé ou condamnation



CPL Dark Structure



White

Grey Euroinvest

Light Concrete

Dark Concrete



Whitenened Walnut

Oak Milano 1

Oak Milano 2

Oak Milano 4

## COULEURS

### Décor CPL HQ 0.2 ★★★★★☆

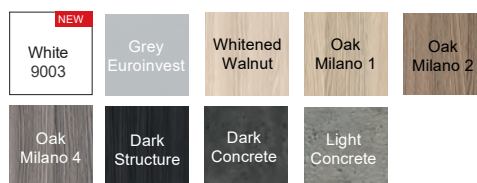

### Portalamino ★★★★★☆

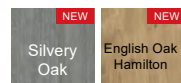

# Porte LINE



Porte à recouvrement  
Ame alvéolaire  
3 fiches  
Serrure à clé ou condamnation



LINE H1 Concrete Dark



LINE F.1  
White



LINE E.1  
Grey Euroinvest



LINE H.1  
Light Concrete



LINE B.1  
Dark Structure



LINE C.1  
Whitened Walnut



LINE F.1  
Oak Milano 1



LINE B.1  
Oak Milano 2



LINE E.1  
Silvery Oak

## COULEURS

### Décor CPL HQ 0.2 ★★★★★☆

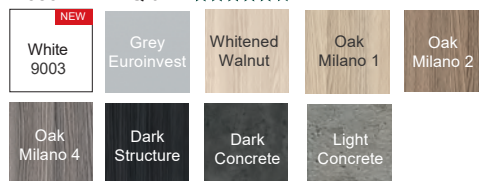

Insert Aluminium



Insert Noir

### Portalamino ★★★★★☆

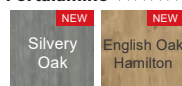

# Porte RESIST



Porte à recouvrement  
Ame alvéolaire  
3 fiches  
Serrure à clé ou condamnation



RESIST 1.1 Halifax Natural



RESIST 7.1  
Halifax Natural



RESIST 7.1  
Sand Oak



RESIST 1.1  
Sand Oak



RESIST 7.1  
Brown Oak



RESIST B.1  
Oak White



RESIST E.1  
Oak White



RESIST H.1  
Oak White

## COULEURS

Gladstone / Halifax ★★★★★★

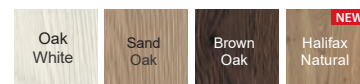

Insert Aluminium



Insert Noir



# Porte CONCEPT, group A



Porte à recouvrement  
Ame pleine  
3 fiches  
Serrure à clé ou condamnation



CONCEPT A.9 English Oak Hamilton



CONCEPT A.0  
English Oak Hamilton



CONCEPT A.2  
English Oak Hamilton



CONCEPT A.3  
English Oak Hamilton



CONCEPT A.4  
English Oak Hamilton



CONCEPT A.5  
English Oak Hamilton



CONCEPT A.6  
English Oak Hamilton



CONCEPT A.7  
English Oak Hamilton



CONCEPT A.8  
English Oak Hamilton

## COULEURS

Portaperfect 3D veneer ★★★★★☆

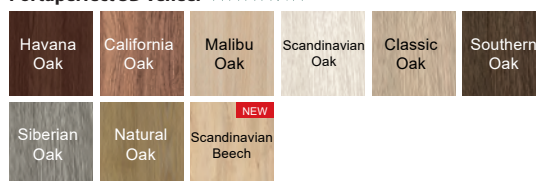

Portalamino ★★★★★☆

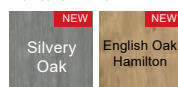

Premium veneer ★★★★★☆



# Porte Vitrée - Miroir



Focus 4.A Siberian



Focus 2.0



Focus 4.B



Fit B.5



Inspire Miroir



Concept H.4



Style 4



Harmony B.2



Nova 5.2

Découvrez un large choix de vitrage dans tous les décors en harmonie avec votre maison.

**Un large choix parmi plus de 3000 modèles qui valoriseront votre habitation et que vous utiliserez avec plaisir.**



# Options

## ■ Ame agglomérée tubulaire

Offre standard



Offre optionnelle



Ame alvéolaire



Ame agglomérée tubulaire



### AVANTAGES:

Meilleure stabilité et isolation phonique

## ■ Serrure magnétique :

Offre standard

Serrure standard



Offre optionnelle

Serrure magnétique



### AVANTAGES:

Fermeture confortable et plus silencieuse

# Poignées

Poignées rosace à clé  
Poignées rosace à condamnation

## ■ ACCENT



## ■ MODERN



## ■ OFFICE

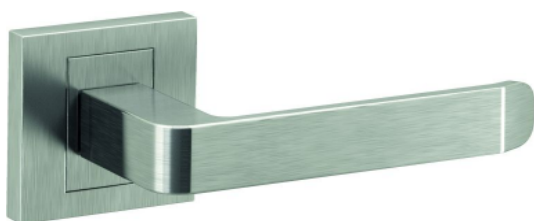

## ■ CARO

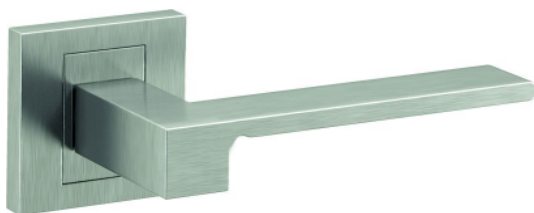

## ■ ORGANIC

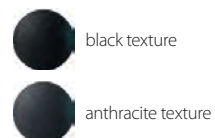

## ■ UNICO

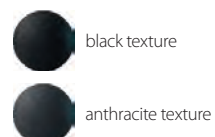

# Cadre Pose fin de chantier

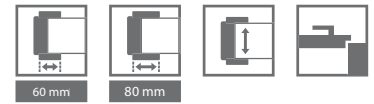

## CADRE CHAMBRANLE CONTRE CHAMBRANLE

Tous nos ébrasements sont équipés d'un joint isophonique de confort. Ils sont ajustés à la taille de votre porte et à l'épaisseur de votre cloison. Ils se fixent à la cloison par simple collage à la mousse bi-composante. Compatible avec tous les modèles de porte PORTA-DOORS.

## COULEURS

**Décor Portasynchro** ★★★★★☆  
**Décor Portaperfect** ★★★★★☆  
**Décor CPL HQ 0,2** ★★★★★☆  
**Gladstone** ★★★★★★

## EPAISSEURS



Modèle de cadre	
A	75 ÷ 95
B, C	95 ÷ 115 120 ÷ 140
D, E	140 ÷ 160 160 ÷ 180
F, G, H	180 ÷ 200 200 ÷ 220 220 ÷ 240
I, J, K	240 ÷ 260 260 ÷ 280 280 ÷ 300

## DIMENSIONS

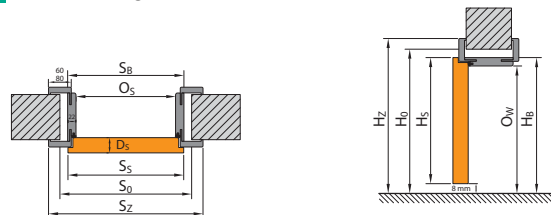

Passages	S <sub>s</sub>	H <sub>s</sub>	D <sub>s</sub>	S <sub>0</sub>	H <sub>0</sub>	O <sub>s</sub>	O <sub>w</sub>	S <sub>B</sub>	H <sub>B</sub>	S <sub>Z</sub> (6)	S <sub>Z</sub> (8)	H <sub>Z</sub>	T <sub>sjw</sub>
60	644	2030	40	680	2060	602	2016	646	2038	746	786	(6) / (8) 2088 / 2108	+20 / +10
70	744			780		702		746		846	886		
80	844			880		802		846		946	986		
90	944			980		902		946		1046	1086		
100	1044			1080		1002		1046		1146	1186		
110	1144			1180		1102		1146		1246	1286		

# Porte en galandage

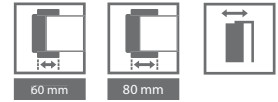

## KIT COMPACT

Le système comprend des éléments coulissants et une cassette de paroi en acier galvanisé à intégrer à l'intérieur de la cloison et un cadre de porte en aggloméré et MDF.

Compatible avec tous les modèles de porte PORTA.

### NOTE

Le système est prévu pour des cloisons de 125 mm

## COULEURS

Décor Portasynchro	★★★★☆
Décor Portaperfect	★★★★☆
Décor CPL HQ 0,2	★★★★☆
Gladstone	★★★★☆

## DIMENSIONS

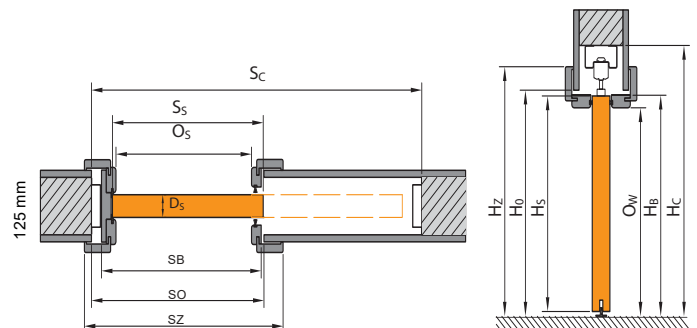

Passages	S <sub>s</sub>	H <sub>s</sub>	D <sub>s</sub>	S <sub>o</sub>	H <sub>o</sub>	O <sub>s</sub>	O <sub>w</sub>	S <sub>b</sub>	H <sub>b</sub>	S <sub>z</sub> (6)	S <sub>z</sub> (8)	H <sub>z</sub> (6)/(8)	S <sub>c</sub>	H <sub>c</sub>	T <sub>sw</sub>
60	644	2030	40	660	2065	600	2018	654	2040	744	784	'2090 / 2110'	1355	2130	+10   +5
70	744			760		700		754		844	884		1555		
80	844			860		800		854		944	984		1755		
90	944			960		900		954		1044	1084		1955		
100	1044			1060		1000		1054		1144	1184		2155		

## ■ CHOISIR LE SENS D'OUVERTURE DE LA PORTE

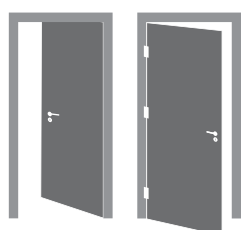

Poussant droit



Poussant gauche

## ■ PRISE DE MESURES

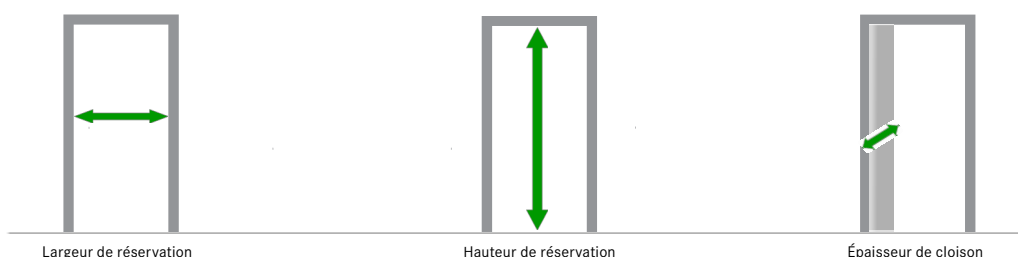

Mesurer en 3 points la largeur, la hauteur et l'épaisseur, prendre en compte la faïence murale et vérifier ci-dessous les dimensions pour s'assurer l'installation des portes standard en fin de chantier.

**Important:** Mesure avec sol et mur finis

## ■ CADRE CHAMBRANLE CONTRE CHAMBRANLE PORTA SYSTEM AILE DE 60MM

Passages	Largeur de porte	Réservation S0		Hors tout
		Conseillée	Mini-Max	
Os	Ss			Sz
600	644	690	680-700	746
700	744	790	780-800	846
800	844	890	880-900	946
900	944	990	980-1000	1046
<b>Hauteur</b>	<b>2030</b>	<b>2060</b>	<b>2050-2070</b>	<b>2088</b>

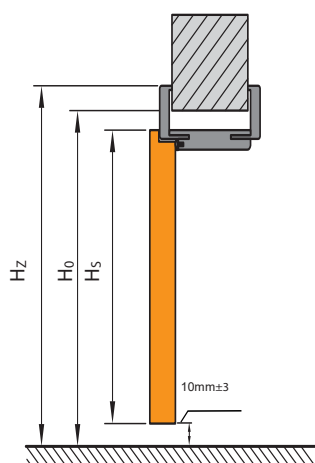

Prévoir 4 cm minimum de retour de cloison de chaque côté de la réservation.

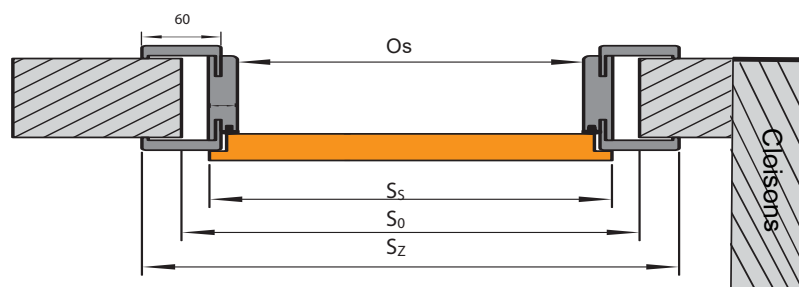



# Fiche Technique

## ■ CHANGEMENT DE REVETEMENT DE SOL SOUS LA PORTE

### Important :

Fiche à remettre à tous les poseurs de sols (chapiste, carreleur, parqueteur).

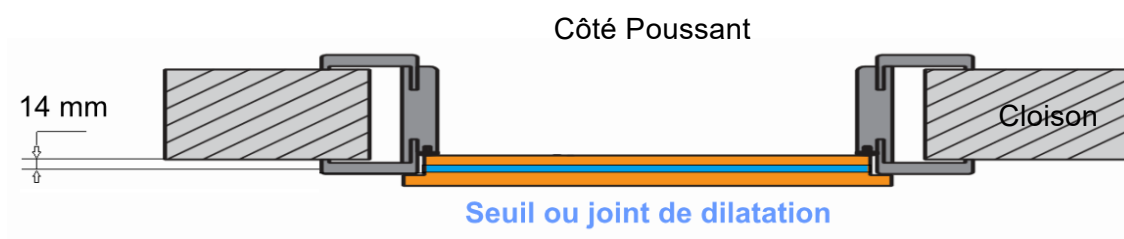

Pour changer de revêtement de sol sous la porte, il faut se placer côté ouvrant dans la pièce. Ensuite tracer au sol l'axe du vantail à recouvrement qui sera de 14mm depuis la cloison pour les portes standard (40mm).

## ■ EXEMPLES EN PHOTOS :

Porte fermée



Porte ouverte avec changement de revêtement de sol



# Pose des portes



Assembler le chambranle de la porte selon la notice du fabricant.

1



Placer le positionneur aux dimensions définies dans le chambranle afin que le tube se trouve au milieu de la profondeur.

2

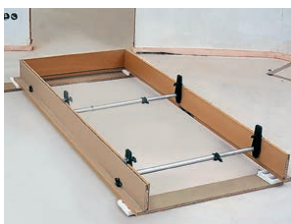

Positionner les écarteurs à la hauteur de la serrure de la porte et à la hauteur de la charnière inférieure.

3



Pour ce faire, introduire l'étrier de serrage dans la rainure et serrer en douceur. Les barres et le cadre de porte forment ainsi une unité.

4



Insérer le cadre de porte dans la découpe du mur et sécuriser pour éviter tout basculement.

5



Fixer à nouveau le support sur l'étrier de serrage et aligner le cadre de porte.

6



Remplir avec de la mousse de montage et laisser durcir.

7



Une fois la colle durcie, couper l'excédent et retirer les serre-joint de cadre et les positionneurs de porte. Placer le contre-chambranle décoratif.

8

## Outils de pose (en vente sur demande)



Positionneur pour chambranle de porte



Serre-joint pour cadre de porte



Gabarit de perçage

### UN SYSTÈME INGÉNIEUR

Pose rapide et facile

### PRODUITS PRÊT À L'EMPLOI

Aucune découpe

### PRODUIT LAQUÉ ou REVÊTU D'UN DECOR

Pour une finition parfaite

### POSE DES PORTES EN FIN DE CHANTIER

Portes intactes

## Vidéo de pose de nos portes

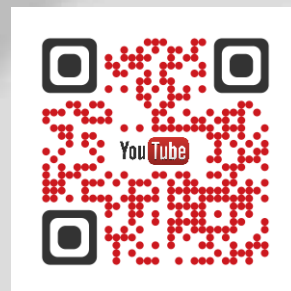

Flashez ce QR-Code !

**P**  
**PORTA**



[www.porta-doors.fr](http://www.porta-doors.fr) [contact@porta-doors.fr](mailto:contact@porta-doors.fr)

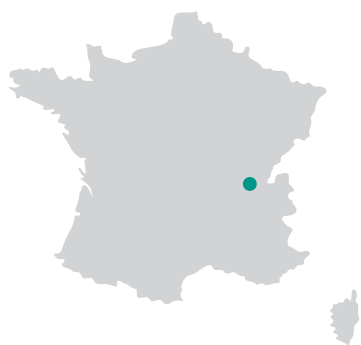

Vos interlocuteurs :

**Nénad PAVLOVIC** Tél.: 06.75.67.10.82  
[nenad.pavlovic@porta-doors.fr](mailto:nenad.pavlovic@porta-doors.fr)

**Christopher LORRAIN** Tél.: 07.62.78.16.90  
[christopher.lorrain@porta-doors.fr](mailto:christopher.lorrain@porta-doors.fr)



## **VISITE SHOW-ROOM**

**TOUS LES JOURS SUR RDV**

**53 rue du 1er septembre 1944**

**01160 Pont d'Ain**

**(Face à la sortie d'autoroute n°9 PONT D'AIN)**