

A woman with long brown hair, wearing a white long-sleeved top and grey trousers, is leaning against a white door. She is looking towards the camera. The setting is a modern interior with light-colored walls and a wooden floor. To the right, another doorway is visible, leading to another room. The overall atmosphere is clean and minimalist.

# [PORTA]

**CATALOGUE 2026**

Doors for Houses  
and Apartments



THE CATALOGUE IS  
AVAILABLE ONLINE IN  
INTERACTIVE FORM

Well-designed doors

About us	2
We support architects and we train installers	4
Sustainable development	6
Find the door through your need	8
TIPS for a good start	16
SPECIAL OFFERS	24
<b>Design lines</b>	<b>28</b>
Modern Classic	30
Classic	46
Basic Home	64
Hide	80
Motive	88
Geometric	96
Horizontal	106
Rustic	138
Vertical	150
Glass	162
<b>Folding doors and sliding systems</b>	<b>170</b>
Technical information and additional accessories	188
<b>Accessories</b>	<b>190</b>
Handles	190
Additional accessories and glass panes	202
<b>Door frames</b>	<b>204</b>
What to consider when choosing a door frame	206
Types of door frames	212
Door frame extensions and skirting boards	230
<b>Additional solutions</b>	<b>232</b>
Side Panels	232
Ventilation	233
<b>Contract / bespoke solutions</b>	<b>234</b>
<b>Entrance doors, technical doors</b>	<b>236</b>
Apartment entrance doors	236
Garage doors	240
PORTA THERMO External steel doors	242
<b>Available finishes</b>	<b>252</b>
<b>Dimension tables, technical drawings</b>	<b>266</b>

See other PORTA catalogues. Check the inside of the back cover.







## Explanation of symbols describing the properties of our products

### How to read pictograms



#### Door leaf

-  Available sizes single-leaf door: min. '60', max. '100'
-  Available sizes double-leaf door: min. '90', max. '220'
-  Increased height door leaf '220'
-  Sliding door leaf
-  Rail and stile door leaf





#### Door frame

-  Non-rebated
-  Rebated
-  Reverse rebate
-  Architraves available in two sizes: 60 mm and 80 mm
-  Door frame adjustment available
-  Fixed

#### PORTA KLIMA

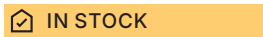
-  PORTA KLIMA I Standard interiors
-  PORTA KLIMA II Different heating systems
-  PORTA KLIMA III Rooms with big differences in humidity and temperature

#### Pay attention to the markings:

-  **IN STOCK**  
Products available in our warehouse – you can have them off-the-shelf!
-  **NEW**  
New in our collections – get inspired and choose the perfect one for you!
-  **HYDRO PROTECT™**  
A new generation of 100% waterproof door frames – protect yourself against humidity!
-  **ACOUSTIC PACKAGE**  
Products with acoustic package – reduce noise in the room by up to half!

 New additions to our finishes charts

 Mirror, additional option

 PORTA CONTRACT bespoke solution

#### Parameters

 **AQUA STOP** - lower edge protection against humidity in TechnoPORTA technology

 TechnoPORTA Technology

#### Take a look at the back of the catalogue

On the back cover, you will find a product index and classification of finish groups.

#### AVAILABLE FINISHES

We have divided it into three categories: Uni colours, synthetic veneers with wood patterns of various types and graining (Modern, Traditional, Rustic), and natural veneers. This makes it easier to find what you need.

Check [➔ 252](#)



**PORTA**

Quality you can afford

# Process of choosing a door should be simple, intuitive, and tailored to your needs. This is how we designed PORTA catalogue.

The catalogue will guide you step by step through PORTA solutions and help you choose the right doors for your interior.

In this catalogue, we have listed the most common challenges faced by our customers and our proven solutions.

## How will the catalogue guide you?

### STEP 1. DEFINE YOUR NEEDS

Let's start with the most important thing – what kind of door do you need:

- humidity-resistant, but without the need to compromise on the aesthetics of the interior [➤ 8](#)
- concealed that will subtly blend into the interior design [➤ 10](#)
- tailored to the needs of owners and their pets [➤ 12](#)
- or those that will provide you with peace and quiet [➤ 14](#)

### STEP 2. CHECK WHAT YOU NEED TO KNOW BEFORE CHOOSING A DOOR

On the following pages, you will find practical advice from our experts. We explain, among others:

- what determines the price of a door [➤ 16](#)
- how to correctly define the door opening direction [➤ 17](#)
- what is the door ordering process like? [➤ 18](#)
- which door frame to choose [➤ 19](#)
- what door constructions you can choose [➤ 20](#)

### STEP 3. FIND YOUR PORTA DESIGN

We have divided the catalogue into 10 clear design lines, making it easy for you to find your favorite one.

See our design lines [➤ 28](#)

### STEP 4. CHOOSE THE COLOUR AND FINISH OF THE DOOR

At the end of each design type, you can find finishes charts that will help you to personalize your chosen door.

See our colour finishes and options [➤ 252](#)

Well-conceived doors – where design and functionality come together as one.



Please pass on the catalogue to others before recycling it.  
Good doors are worth recommending!

Get to know us

# Well-designed doors

For over 35 years, we have been making doors that combine high-quality workmanship, durability, and modern design.

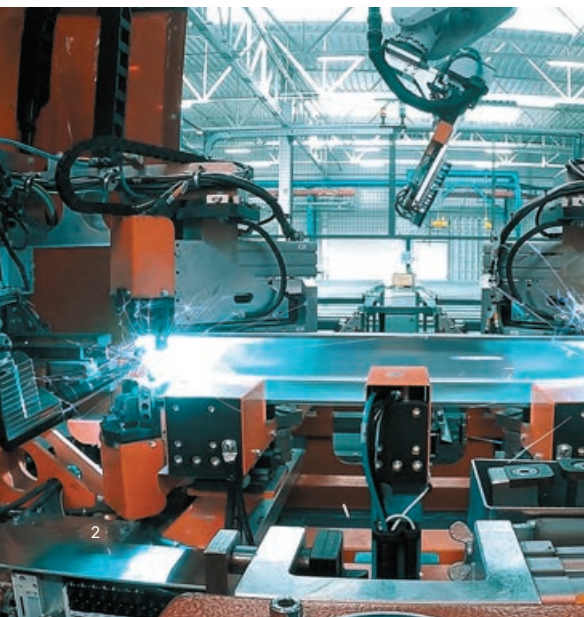

## PORTA Prizes



# Customer trust has made us **number 1** in Poland and Central and Eastern Europe for years.

PORTA produces doors in 6 factories: 5 in Poland and 1 in Romania.

We operate globally. We are present in 43 countries. PORTA doors can be found worldwide in numerous investment projects, such as residential buildings, hotels, theatres, hospitals and stadiums.

We offer a full range of solutions: from interior and apartment entrance doors to exterior doors – all made with the utmost care and attention to every detail.

We know how important durability is, which is why our products undergo rigorous testing in 21 research institutes in Poland and abroad. It ensures that they remain reliable for years to come.

Join millions of customers who trust PORTA quality.

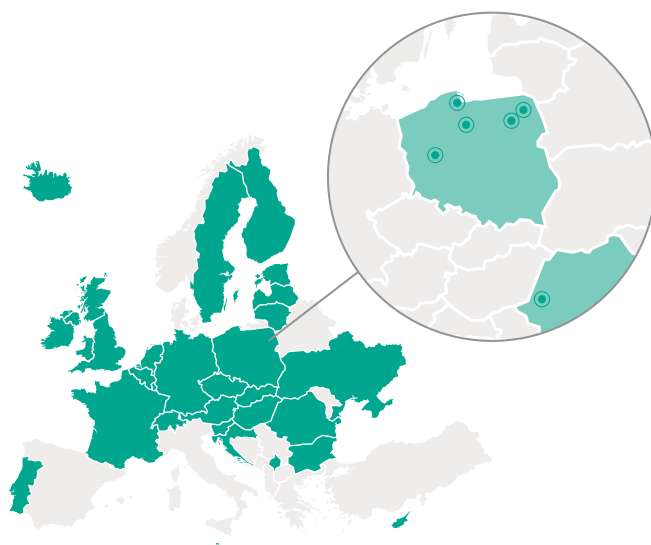

### PORTA in numbers

**35 years**  
of experience

**~ 1.7 million**  
doors produced  
per year

**1 700**  
committed  
employees

**50+**  
the countries  
we reach and inspire

**2 500+**  
points of sale where  
you can experience  
our quality



# We make it easy to choose the perfect door

We have made PORTA KLIMA markings to help you choose the door that is perfectly suited to a particular function. Look for the PORTA KLIMA icons on our collections – they indicate long-term durability and performance.

## PORTA KLIMA I

Ideal for apartment interiors where all rooms have similar temperature and humidity levels.

All collections of interior doors from PORTA.

## PORTA KLIMA II

They will work well with small temperature differences, e.g. between a heated stairwell and an apartment. Perfect for public buildings where rooms connect to corridors with different heating systems.

Interior door collections:

PORTA DECOR, PORTA VECTOR PREMIUM, PORTA RESIST, PORTA CPL, PORTA LINE, PORTA LEVEL LINE, ART DECO, OSLO, 4 ELEMENTS, FACTOR, LOFT, LEVEL, NOVA, VERTE BASIC, CPL and DECOR BASIC, NATURE LINE, NATURE CLASSIC

Flush solid doors with chipboard/hollow chipboard core + reinforced PS door frame.

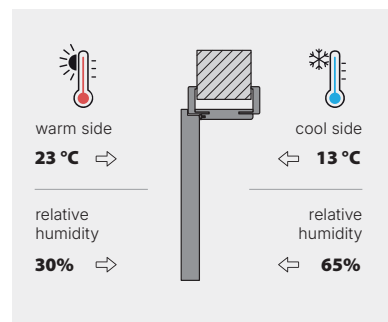

## PORTA KLIMA III

Indispensable for large temperature differences. Choose them to separate heated and unheated rooms (basement, attic) and for all entrance doors exposed to external conditions.

Interior door collections:

Collections as in class II + aluminum sheet + steel or **HYDRO PROTECT™** door frame

All apartment entrance doors from the PORTA range.

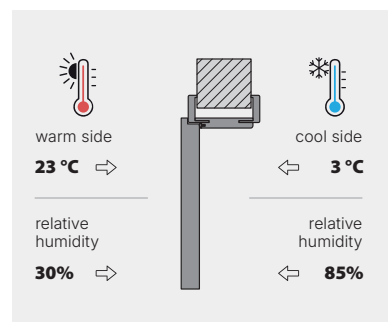

### Why does climate class matter?

Different rooms = different conditions (temperature, humidity). Doors selected from an inappropriate class may become deformed or suffer damage over time.

Class	Condition differences	Where to use	Examples	Temperature difference (°C)	Relative humidity difference (%)	Maximum deflection (mm/m)
PORTA KLIMA I	Minimal	Standard interiors	Living room/bedroom, kitchen/hall	±5 °C	±20%	<= 4mm longitudinal / <= 2mm transverse
PORTA KLIMA II	Medium	Different heating systems	Staircase / apartments, hotels, hospitals, offices, schools	±10 °C	±35%	<= 4mm longitudinal / <= 2mm transverse
PORTA KLIMA III	Substantial	Rooms with big differences in humidity and temperature	Entrance doors from unheated stairwells to apartments, basement doors, doors to unheated attics	±20 °C	±55%	<= 4mm longitudinal / <= 2mm transverse

The benefits of making the right choice:

- ✔ Longer service life
- ✔ No deformation
- ✔ Airtight
- ✔ Energy savings

We care about the environment

# Responsibility in every detail

## Sustainable production Saving resources

Modern technologies allow you to save up to 60% of electricity. The PORTA TransAPI system optimizes material consumption.

### PORTA actions

We implement projects that use renewable energy sources and biomass systems to produce electricity and heat.

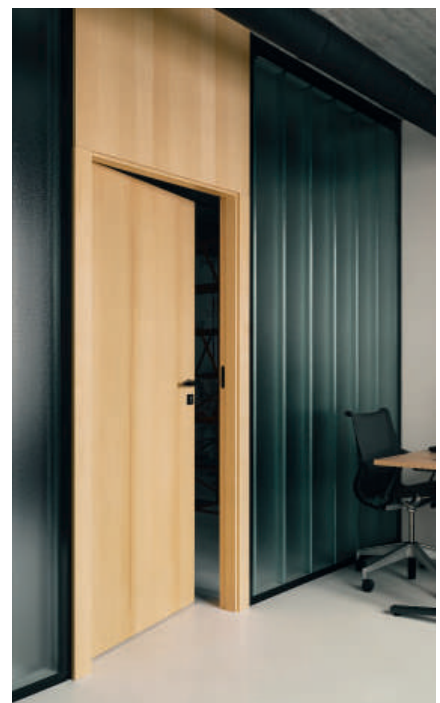



## Transparency

Responsibility for the environment and sustainable development are an integral part of PORTA's policy.

We are consistently developing our environmental policy. Product certifications confirm our actions for the planet.

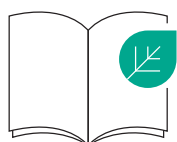

Please pass on the catalogue to others before recycling it.

Good doors are worth recommending!

## ECOdesign

We design doors with their entire lifecycle in mind, creating durable solutions like the **HYDRO PROTECT™** door frame that is designed to last for years.

We use water-based varnishes that are free of VOCs and harmful substances – safe for allergy sufferers and children. UV hardening extends the life of the product and guarantees colour durability.



NEED: Resistance to water and humidity

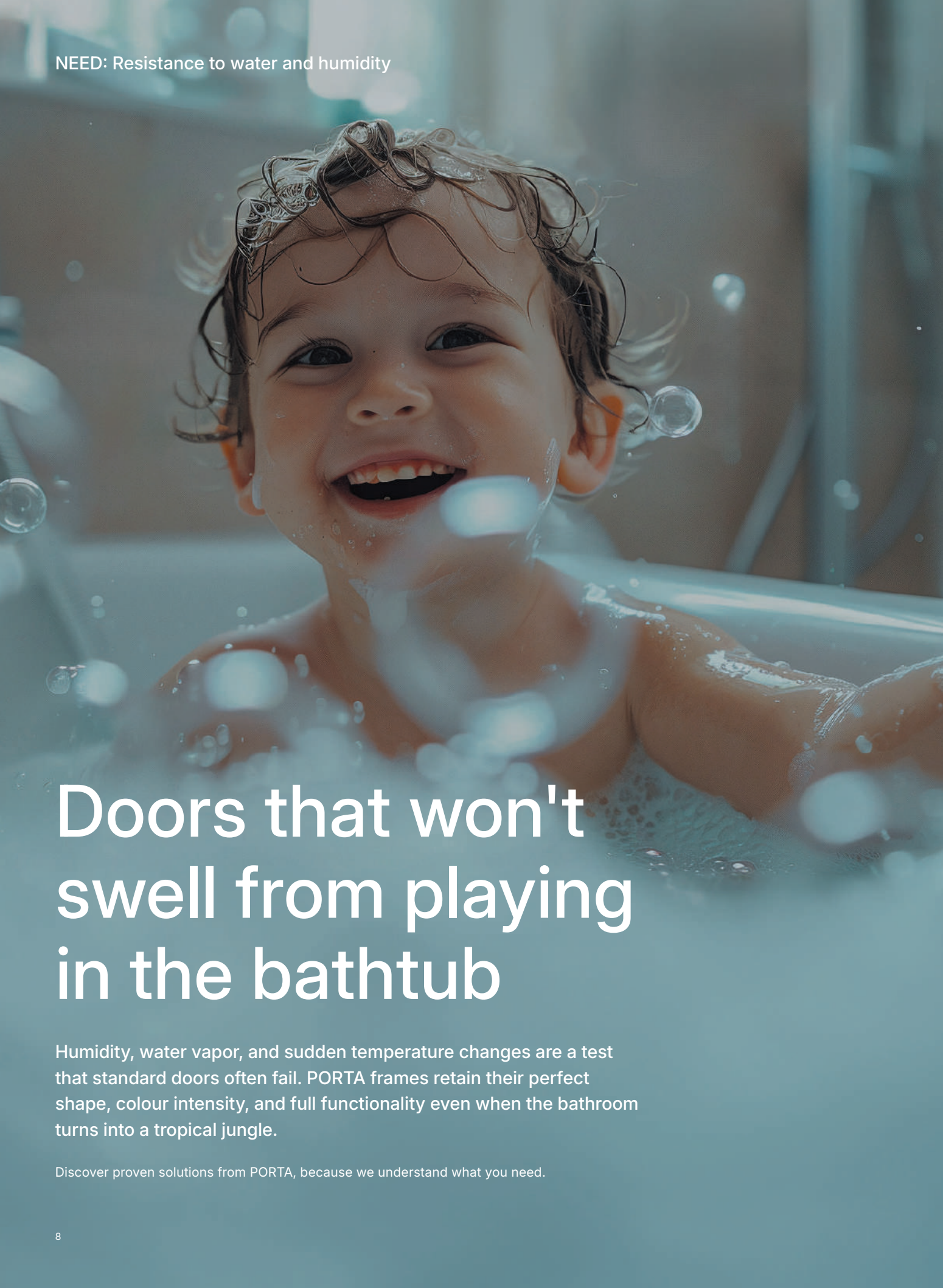

# Doors that won't swell from playing in the bathtub

Humidity, water vapor, and sudden temperature changes are a test that standard doors often fail. PORTA frames retain their perfect shape, colour intensity, and full functionality even when the bathroom turns into a tropical jungle.

Discover proven solutions from PORTA, because we understand what you need.

# Waterproof door frames

Look for markings  
HYDRO PROTECT™

## HYDRO PROTECT™

Door frame for special tasks. Made of **waterproof** wood-polymer composite, it will never soak up water or swell. This will ensure that it always **looks perfect**, and the door will remain **functional and reliable**. Most importantly, it looks identical to other PORTA SYSTEM door frames, creating consistency in the design of all doors in your house.

Read more [➤ 212](#)



Discover the advantages of  
**HYDRO PROTECT™**  
door frame

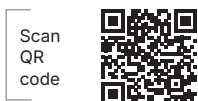

## Steel door frames

A solution that provides peace of mind for years to come—they have increased resistance to humidity, flooding, and corrosion. They are **extremely durable** and do not require your attention for a long time. In addition, they give you a lot of **design freedom**.

Read more [➤ 226, 228](#)

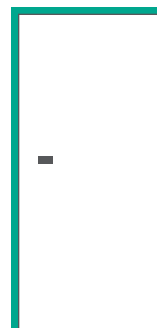

Any RAL / NCS colour

# AQUA STOP protection

## More peace of mind in everyday use

**AQUA STOP** this **unique, hydrophobic coating**, which effectively protects the lower edge of the door leaf against water absorption.

The comfort you deserve and the confidence you need – in selected interior door models at no extra charge.



## Extended durability of your doors

This is invisible protection for doors in the area most exposed to humidity.



Products marked with the icon have **AQUA STOP** protection

# Discreet and efficient ventilation

## Solutions

Proper air circulation is crucial for your well-being and for protecting your interior. That is why we offer two proven solutions.

Read more [➤ 233](#)

## Recuperative shortcut

A flat, minimalist cutout in the lower edge of the door leaf, allowing for free airflow. It is especially suitable for energy-efficient buildings, supporting **efficient use of heat**. This solution was created for those who value maximum **discreet ventilation solutions**.



## Ventilation undercut

A specially cut trapezoid at the bottom of the door leaf, which ensures **free air flow** between rooms.



NEED: Freedom of arrangement

# Doors that disappear to enhance the space

Minimalist form and maximum freedom of arrangement. PORTA HIDE  
- allows you to create an interior where design and your story take center  
stage, with the door serving as a discreet backdrop.

Choose concealed doors and design them according to your own ideas!

## Unlock the full potential of your space

### Doors just the way you want them

PORTA HIDE can be treated like a canvas. You can paint them any colour you choose for your interior. You can also use a wide range of wall materials to finish the front of the door, such as lacobel (lacquered glass), veneer, lightweight panels, and even trendy microcement.

### Conceal bathroom door

Concealed door in the bathroom? Why not! They are available with a ventilation undercut or a recuperative shortcut.

### What are concealed doors?

This solution perfectly aligns the door leaf with the wall, making the frame invisible. This creates an even surface. The doors blend subtly into the background and visually enlarge the space, making them a great choice for smaller apartments.

#### Tip



**BUY CONVENIENTLY AS A SET**

door leaf + door frame + door handle  
Check out on page [190](#)



Decorate with any pattern

### Take care of the acoustics

Instead of honeycomb filling, you can choose hollow chipboard for an additional charge, which guarantees significantly better acoustics.

The doors are also available with an acoustic package.

Check out at page [13](#)

### PORTA HIDE

Scan QR code and find out more about PORTA HIDE



## Arrange freely

- Wallpaper
- Paint
- Add wall moldings
- Order in natural veneer
- Order in synthetic veneer
- Order higher doors PN '220' or CN '210'



Cover with inspiring wallpaper



Paint it your favorite colour

NEED: Quiet and privacy

# Doors that allow you hear yourself

When your work calls for silence, but children's laughter and your pet's excitement fill the home, choose PORTA doors with an acoustic package that reduces noise by up to 50%. Let your home keep its natural rhythm.

Choose PORTA solutions and leave your emotions on the right side.

## Solutions that work



### Drop-down threshold seal

It isolates sounds and restores balance. Perfect for: home office (where remote work requires concentration), children's room (where emotions are always louder) bedroom (where it provides silence and intimacy).

It operates discreetly—it retracts automatically when the door is closed. In addition to reducing noise, it fills the gaps between the door and the floor, effectively stopping drafts, unwanted light rays, and heat loss.

### Forget about slamming

#### Magnetic lock

Another important element in maintaining silence is the magnetic lock, which ensures that the door closes quietly.

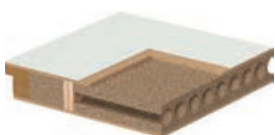

### Hollow chipboard core

Together with the automatic threshold seal, it allows the room to be silenced by up to 6 dB. This change has a real impact on your well-being—it can be compared to reducing street noise to the level of a quiet conversation.



### Seal function

It dampens unwanted sounds coming from beneath the threshold.

## ACOUSTIC PACKAGE

Look for markings  
ACOUSTIC PACKAGE

Scan QR code



### PORTA's offer includes doors with an acoustic package.

The door features a hollow chipboard core and a drop-down threshold seal.



## Tip

### Maximum silence

If maximum soundproofing and guaranteed privacy are your priorities, choose solid doors — they are the most effective way to ensure acoustic privacy.

NEED: Damage resistance

# Doors made for living with a pet

PORTA doors are ready for the daily challenges and energy of pets. With their resistant surfaces and durable finishes, they are ideal for busy interiors.

Check out our door tips for pet owners.

## Details that make living together easier



### Door for a dog or a cat.

They allow your pet to move freely between rooms, even when the doors are closed. We adjust the size and shape of the pet flap to the needs of your furry friend.

Find out more at page [234](#)



### Opening for a pet flap

We can prepare it in any door leaf with chipboard or hollow chipboard core. We mill holes for rectangular and round flaps.

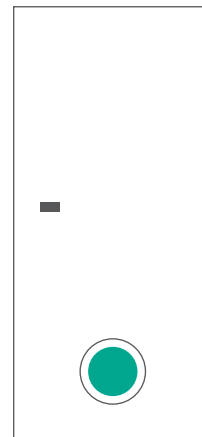

## Durable laminates and veneers

In places where pets live, good choice of finish is crucial for durability. That's why our finishes have been classified according to durability levels. By choosing highly durable options, you ensure that your doors are protected against scratches and easy to keep clean.

Discover our range of options and choose from a selection of durable finishes that match your interior. Among the finishes with increased and high durability, you will also find those that can be easily matched to the colour of your furniture or floor panels.

Information about finishes and colours can be found on page [252](#)

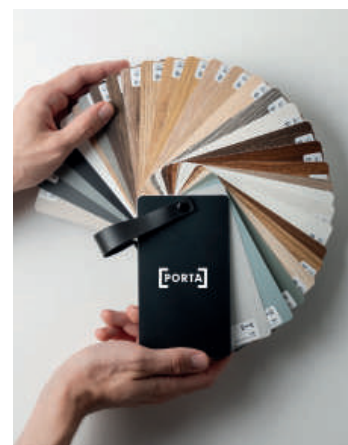

## Tip

### Don't want your dog or cat to open the door by itself?

Choose a knob instead of a handle. You can find original knobs from PORTA at page [190](#)

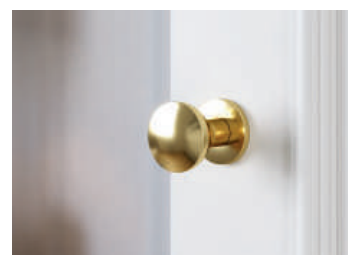

# 6 things worth knowing about doors

## 1 | What does affect the cost of a door?

The final cost of the door consists of several elements:

- + Door leaf
- + Door frame
- + Door handle and other accessories

Additionally, add  
+ Installation

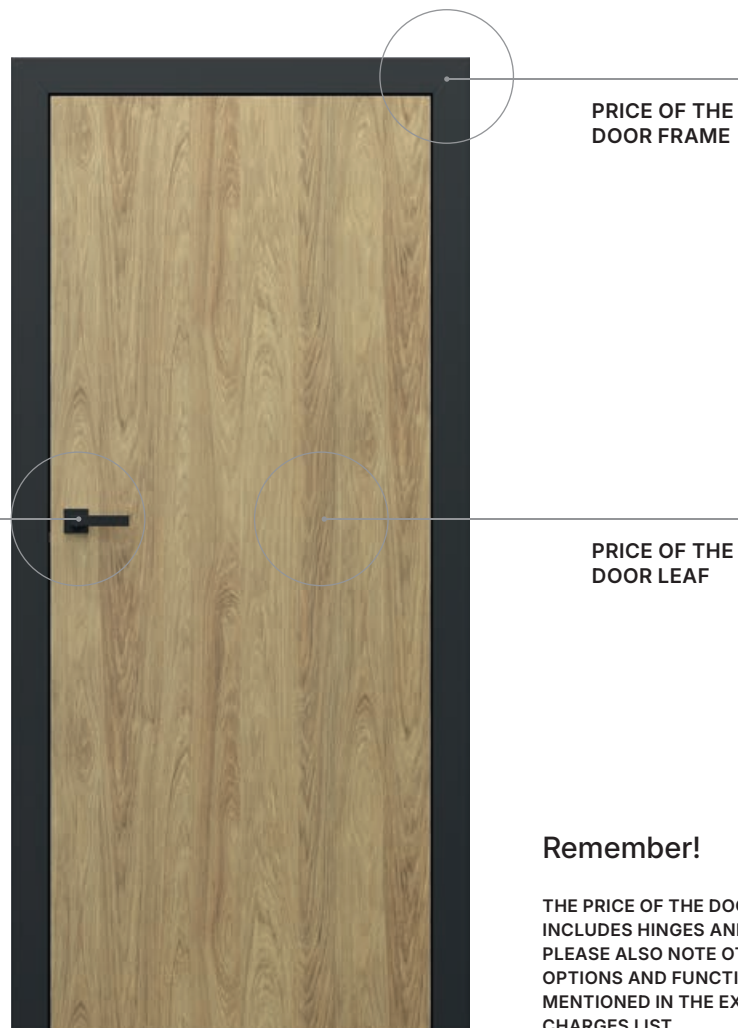

### Tip



**BUY CONVENIENTLY AS A SET**

door leaf + door frame + door handle  
Check out on page [190](#)

### Remember!

THE PRICE OF THE DOOR INCLUDES HINGES AND A LOCK. PLEASE ALSO NOTE OTHER OPTIONS AND FUNCTIONALITIES MENTIONED IN THE EXTRA CHARGES LIST.



## 2 | Right-hand door or left-hand door?

Should your door open to the left or to the right?  
This is a crucial decision for the comfort of using  
and moving around the rooms.

### Opening direction

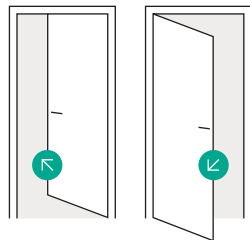

**Single-leaf door, rebated  
and non-rebated**  
Left door leaf

Top view

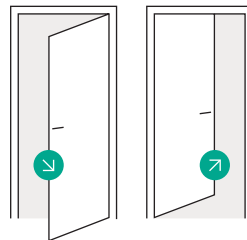
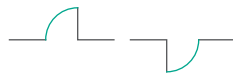

**Single-leaf door, rebated  
and non-rebated**  
Right door leaf

Top view

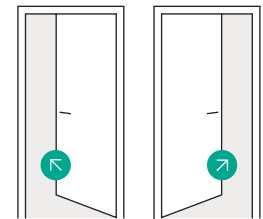

**Single door with reverse  
rebate**  
Left and right door leaf

Top view

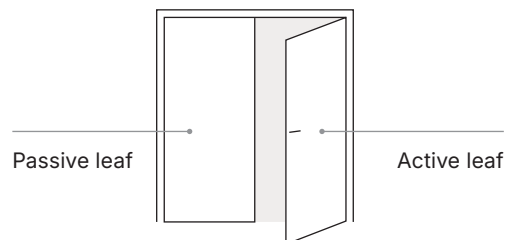

**Double-leaf door**

Top view



## 3 | Completion date

### You choose, we produce

---

#### 01 Pick a door

Find a door and tailor it to your needs. Choose the color, handle, model and the seller will tell you the rest.

---

#### 02 Order at the point of sale

Visit [www.portadoors.com](http://www.portadoors.com) to find your nearest sales point. This is where you can order your doors.

---

#### 03 The factory – where the magic happens

At the PORTA factory, your order turns into a door. We produce them especially for you.

---

#### 04 Delivery

Once your order is ready, we ship it immediately to the sales point.

---

#### 05 Door pickup

You can pick up the door in person at the store or go for delivery from the sales point.

---

#### 06 Quick installation

Check with your dealer to see if you can use the installation service.

---

## 4 | Non-rebated and rebated doors, or perhaps doors with a concealed frame – which to choose?

The choice of door type affects both the aesthetics of the interior and the comfort of using the space.

You can find out more about the types of door frames and the options at page [204](#)

### Types of door frames



If you are looking for traditional but less costly doors, choose rebated ones with visible hinges.

#### Rebated

With visible hinges

Marked with an icon:



Doors with concealed hinges (non-rebated or with reverse rebate) are ideal for modern interiors, where simplicity is important.

#### Non-rebated / with reverse rebate

With concealed hinges

Marked with an icon:

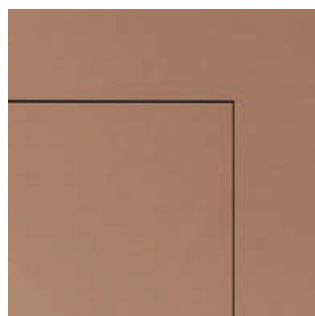

A concealed door frame, on the other hand, is the perfect solution when you want to design an entire wall and thus blend the door into it.

#### Concealed door frame

Look for Porta Hide door

## 5 | Frame and panel construction



door leaf  
thickness  
40 mm

Frame and panel door leaves are constructed of rails and stiles that form a frame, which can then be filled with panels or glass panes. Pins and dowels are used to connect each element.

### Advantages of the construction:

- No visible veneer joints on the outer edge of the door leaf.
- The panes and panels that form part of the construction reinforce the stability of the leaf.

### LOCKS

Options: without keyhole, with key, for cylinder, or bathroom.

### SAFETY GLASS

#### Thickness 4 mm:

- PORTA VERTE HOME
- PORTA BALANCE
- PORTA HARMONY
- PORTA CLASSIC HOME
- SEVILLE
- MADRID
- CORDOBA

#### Thickness 6 mm:

- PORTA CONCEPT
- PORTA INSPIRE
- PORTA CRAFT
- PORTA VERTE PREMIUM
- PORTA GRANDE
- PORTA VERRO
- NATURE GRANDE
- PORTA LUMIA



### AQUA STOP

Lower edge protection against humidity in TechnoPORTA technology.

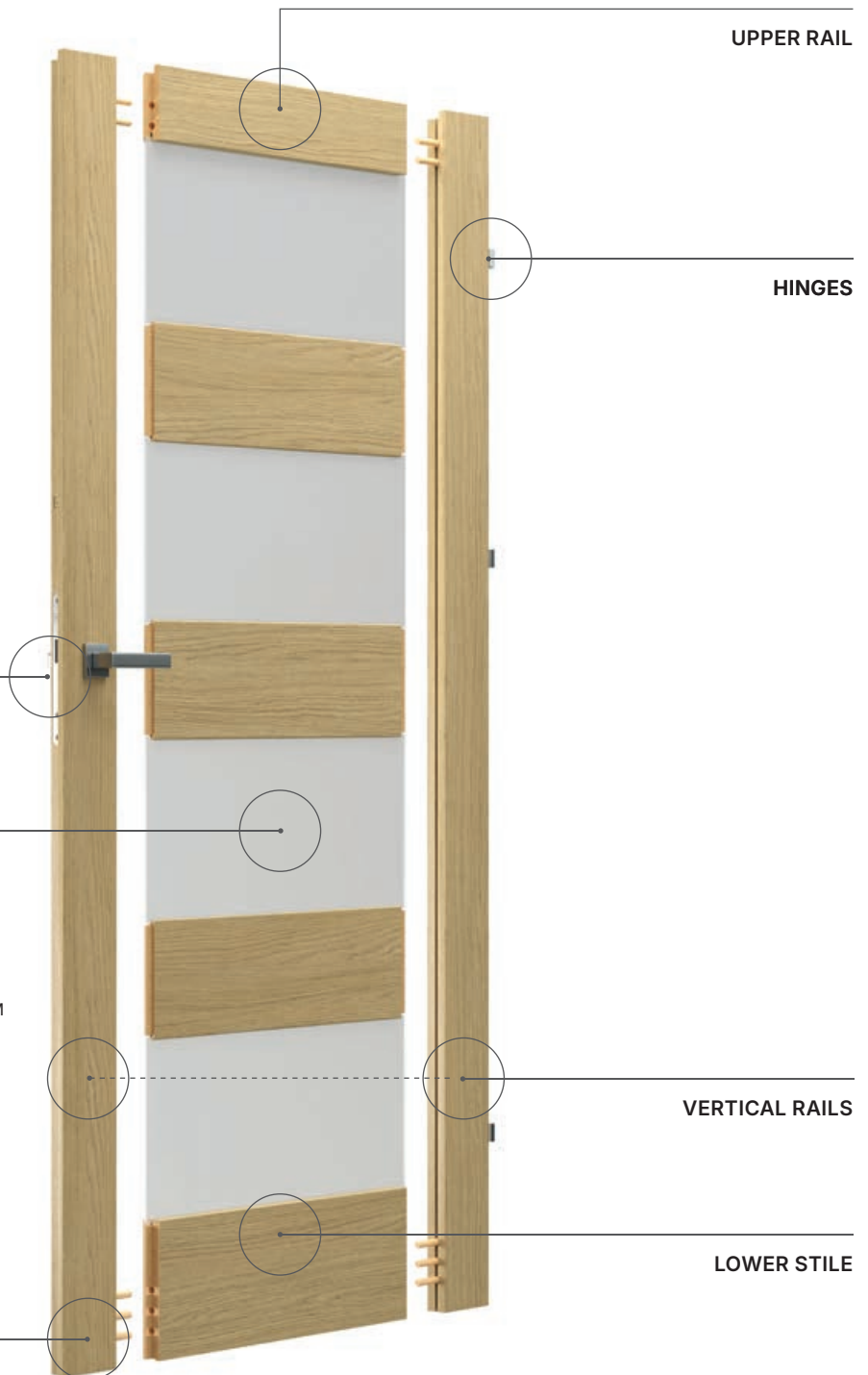

## Construction

### RAILS AND STILES

Rails and stiles are painted or covered with veneer all around (the veneer joints are not visible on the outer edge of the door).

Rails and stiles are joined with dowels and pins.

### GLASS PANEL / SLIM PANEL

Slim panels or panes are installed between the rails and stiles.



## Hinges

### Rebated door

#### BARREL HINGES

Silver included in the price, black available at extra charge.



#### PRIME HINGES AT EXTRA CHARGE (HINGES PACKED WITH DOOR FRAME, PN ONLY)

Gold, matte gold, silver, matte silver.



#### PORTA CONCEPT, PORTA INSPIRE: 3 ADJUSTABLE BARREL HINGES (HINGES PACKED WITH THE DOOR FRAME, PN ONLY)

Silver included in the price.



#### CAPS FOR BARREL HINGES

For interior doors set for one hinge).

Gold, matte silver, glossy chrome - white and black available at extra charge.



### Non-rebated door

#### HINGES FOR NON-REBATED DOORS

Silver included in the price, black, white, and gold available at extra charge.



### Door with reverse rebate

#### HINGES FOR DOORS WITH REVERSE REBATE

Silver included in the price, black, white, and gold available at extra charge.



## Locks

### Non-rebated doors, rebated doors, reverse rebated doors\*

#### KEY LOCK

Silver included in the price, black available at extra charge.



#### MAGNETIC LOCK AND LOCK CATCH

With stainless steel faceplate, black, white, and gold.



\*for doors with reverse rebate only magnetic lock is available

## 6 | Flush door construction



door leaf  
thickness  
40 mm

It consists of durable rails and stiles and a core. The outer layer is an HDF board, finished with the chosen finish.

**Advantages of the construction:**

- The possibility of adapting the construction to your needs (reinforcement or sound insulation). by using an acoustic package)
- Possibility of using durable, scratch-resistant finishes.

**LOCKS**

Options: without keyhole, with key, for cylinder, or bathroom.

**SAFETY GLASS**

**Thickness 8 mm:**

- PORTA FOCUS
- PORTA FOCUS PREMIUM
- PORTA LOFT
- NATURE SPACE
- PORTA RESIST

**Thickness 4 mm:**

- other collections



**AQUA STOP**

Lower edge protection against humidity in TechnoPORTA technology.

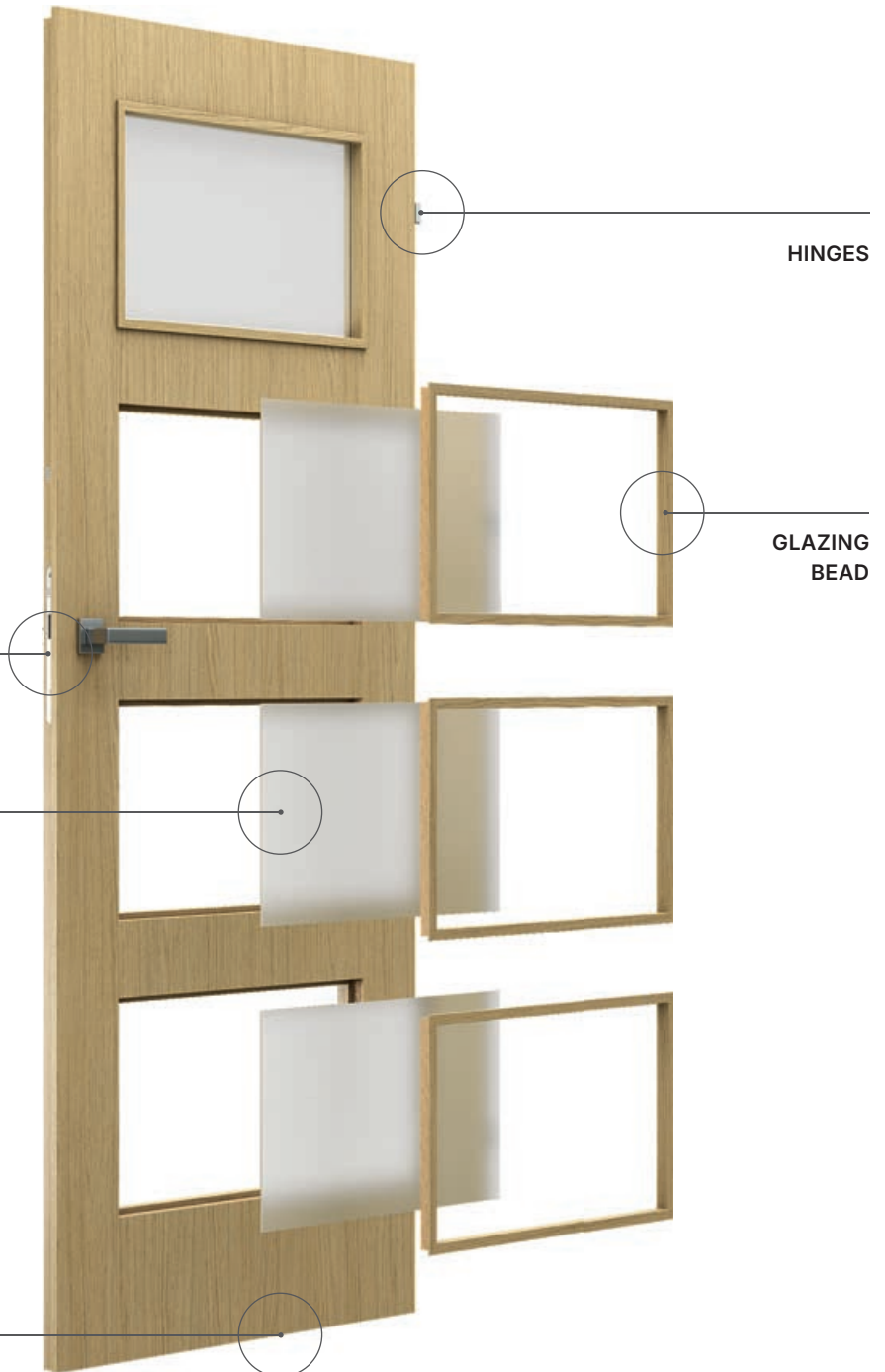

## Construction

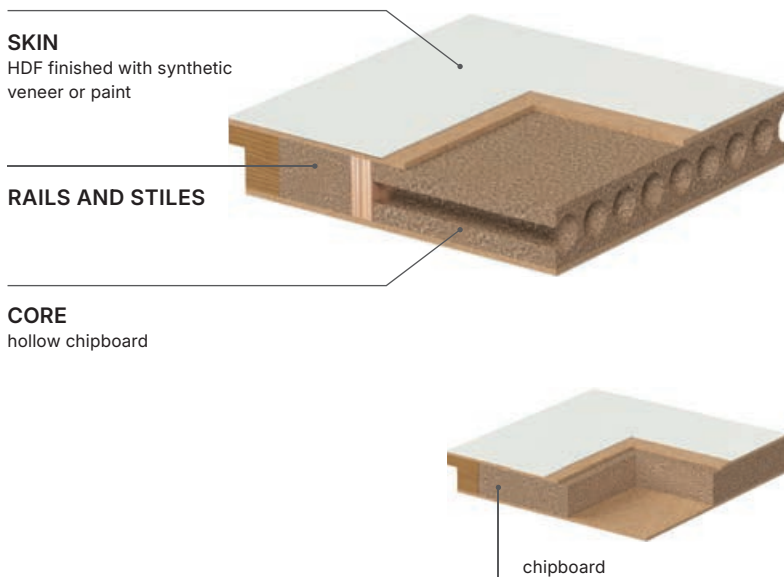

### Chipboard and hollow chipboard

Door with chipboard or hollow chipboard core usually have three hinges because they are heavier. They have better acoustic parameters, which is why they are ideal for offices, teenagers' rooms, bedrooms, or home offices.

### Honeycomb

Interior doors with honeycomb core do not provide good sound insulation, but they are lightweight, making them a good choice for a small child's room. They are also cheaper.

## Hinges

### Rebated door

#### BARREL HINGES

Silver ones included in the price, black available at extra charge.



**PRIME HINGES AT EXTRA CHARGE (HINGES PACKED WITH DOOR FRAME, PN ONLY)**  
Gold, matte gold, silver, matte silver.



**CAPS FOR BARREL HINGES**  
For interior doors (set for one hinge).  
Gold, matte silver, glossy chrome - white and black available at extra charge.



### Non-rebated door

#### HINGES FOR NON-REBATED DOORS

Silver included in the price, black, white, and gold available at extra charge.



### Door with reverse rebate

#### HINGES FOR DOORS WITH REVERSE REBATE

Silver included in the price, black, white, and gold available at extra charge.



## Locks

### Non-rebated doors, rebated doors, reverse rebated doors\*

#### KEY LOCK

Silver included in the price - black available at extra charge.



#### MAGNETIC LOCK AND LOCK CATCH

With stainless steel faceplate, black, white, and gold.



\*for doors with reverse rebate only magnetic lock is available



Reduce noise  
in the room by  
up to half!

# ACOUSTIC PACKAGE

Buy as a set!

## SPECIAL OFFER

In chosen collections, drop-down threshold seal goes with hollow chipboard core at a lower price.

Look for markings 

 ACOUSTIC PACKAGE

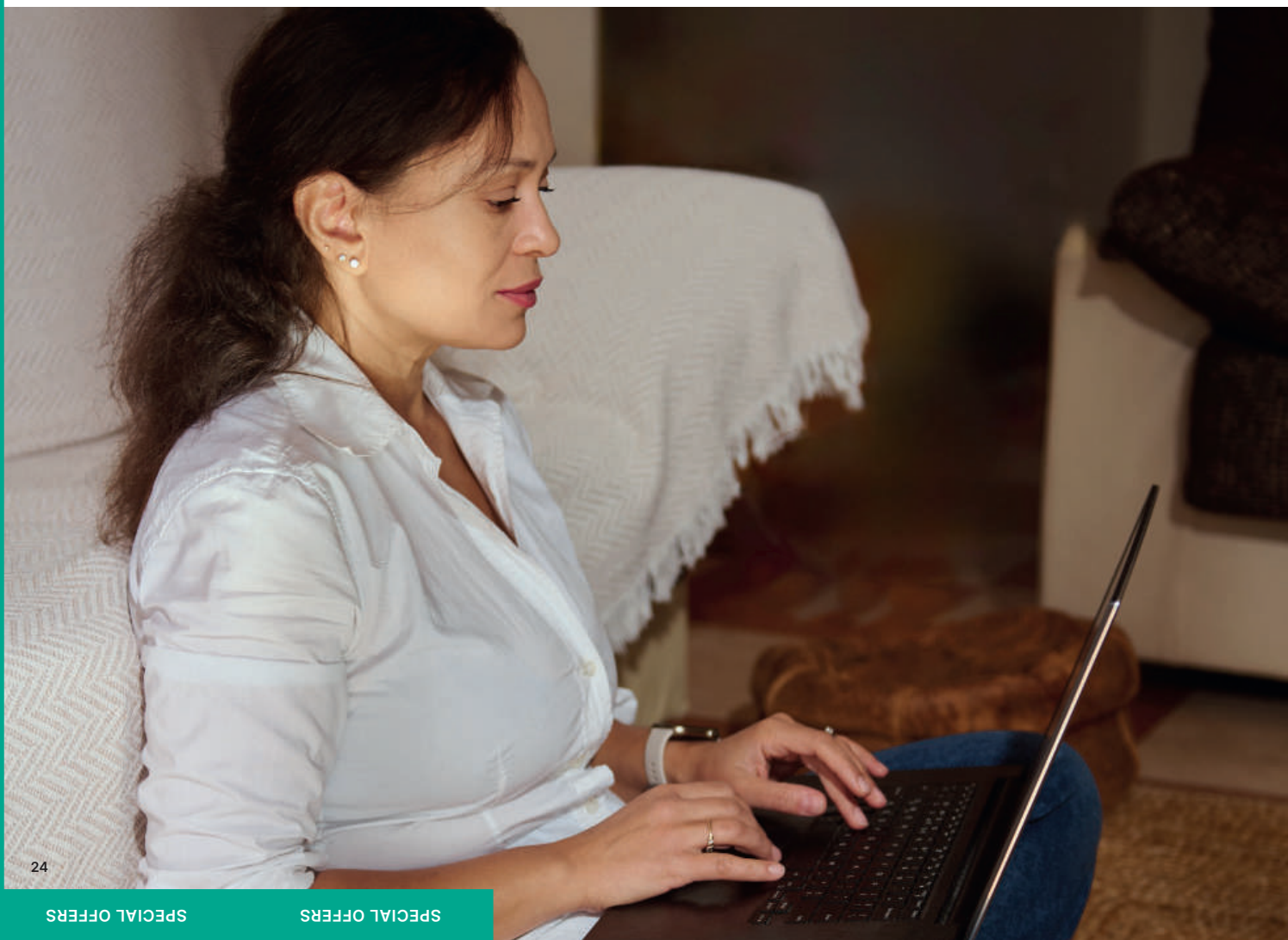

# PORTA HIDE

AT AN EXCEPTIONALLY GOOD PRICE



Scan the QR code and check where to buy PORTA HIDE doors.



# TRIM SOFT

Model P + TRIM SIMPLE  
door frame, range A

TRIM SOFT, TRIM LITE, TRIM SIMPLE:



70-90



Rebated

## Notes

- PN EN 14351-2 standard.
- The doors are available in a rebated option.
- Offer available in sizes 70-90.
- Frosted glazing.
- TRIM SOFT: hollow chipboard core available.

## Accessories

- Three silver barrel hinges, silver key lock or a bathroom lock.



## Door leaf

TRIM / TRIM SOFT: Rails and stiles made from MDF. Core: honeycomb or hollow chipboard core (optionally at extra charge). The construction is skinned with HDF. TRIM LITE: Depending on the model, door leaves consist of MDF rails and stiles with 4 mm thick panels or glass panes between them.

### MODELS

TRIM LITE, models A and B

TRIM, model T.1

TRIM, model T.0

TRIM SOFT, model P

### door frame TRIM SIMPLE range

A (75-95)

B (95-135)

C (120-160)

E (160-200)

## TRIM LITE frame and panel door leaves



TRIM LITE model B.5  
+ Door Frame TRIM  
SIMPLE range A



TRIM LITE model B.2  
with ventilation undercut  
+TRIM SIMPLE door  
frame, range A



TRIM LITE model A.4  
+ door frame TRIM  
SIMPLE range A



TRIM LITE model A.2  
with ventilation undercut  
+ TRIM SIMPLE door  
frame, range A

### (1) Uni Colours



White

### (1) Traditional



Wenge  
White

### (1) Rustic



Catania  
Oak

**PLEASE  
NOTE!**

The number in brackets, e.g.  
(1), indicates the finish group.  
Check the back cover flap.

## TRIM SOFT flush door leaves



TRIM SOFT model P  
+ Door Frame TRIM  
SIMPLE range A

### (1) Uni Colours



Bialy

Szary

### (1) Traditional



Wenge  
White

### (1) Rustic



Catania  
Oak

## TRIM painted door leaves



TRIM model T.0  
+ Door Frame TRIM  
SIMPLE range A



TRIM model T.1  
+ Door Frame TRIM  
SIMPLE range A

### Standard paint



White

## TRIM SIMPLE rebated door frame

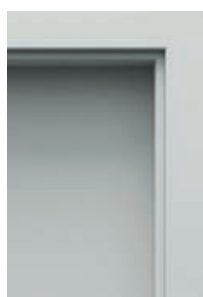

TRIM SIMPLE door frame  
with a 50 mm architrave

### Construction

#### The door frame consists of:

- A door frame head and two jambs, made of wood-based material. It comes with necessary hardware and accessories.
- Architraves (50 mm).

Architrave with adjustment up to 20 mm in range A, for ranges B, C, E architrave with extended tongue with adjustment from 20 up to 40 mm.

Door frame is produced and delivered as a set of elements to assemble on site.

### Notes

- Offer available in sizes 70-90, door frame with adjustment ranges A, B, C, E.
- Technical Assessment ITB-KOT-2018/0358, issue 2.
- Door frame should be installed on finished walls (e.g. wall papers) and on a finished floor (e.g. floor panels).
- The TRIM SIMPLE door frame can only be ordered as part of a set with a door leaf from the TRIM range.

### Accessories

- Three silver barrel hinges.
- Rubber seal set circumferentially.

### Additionally

hollow chipboard core  
ventilation undercut

# Design Lines



**Modern Classic** ↗ 30

Models

PORTA HARMONY  
PORTA GRANDE  
NATURE GRANDE  
PORTA IMPERIAL  
PORTA ORNATO  
AIR  
PORTA BALANCE

PORTA CLASSIC HOME  
✦ NEW



**Classic** ↗ 46

Models

MADRID  
CORDOBA  
PORTA VERRIO  
SEVILLE  
PORTA INSPIRE  
PORTA NOVA  
PORTA VECTOR  
PREMIUM

PORTA FACTOR  
PORTA ROYAL  
LONDON  
VIENNA



**Geometric** ↗ 96

Models

NATURE VERDINO  
PORTA LINE  
NATURE LINE  
PORTA DESIRE

PORTA LEVEL LINE  
✦ NEW



**Horizontal** ↗ 106

Models

PORTA LINE  
Porta RESIST  
NATURE LINE  
PORTA VECTOR  
PORTA GRANDE (B, G)  
PORTA VERTE  
PREMIUM (A, D, E)  
NATURA GRANDE (B)

PORTA VERTE HOME  
(B, C, D, H, J, G, L, N)  
PORTA INSPIRE (C)  
PORTA CONCEPT  
(A, C, H, K)  
PORTA BALANCE (D)  
PORTA FIT (G, H)  
PORTA FACTOR



## Basic Home

➤ 64

### Models

NATURE CLASSIC  
NATURE VERDINO  
EARTH  
PORTA LEVEL  
PORTA VECTOR  
PREMIUM  
PORTA FACTOR

Porta DECOR  
PORTA CPL  
PORTA RESIST  
PORTA LOFT  
FIRE



## Hide

➤ 80

### Models

PORTA HIDE  
Wall paneling

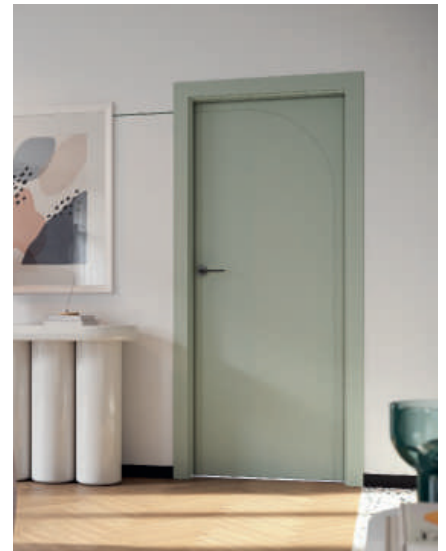

## Motive

➤ 88

### Models

PORTA ART DECO  
WATER  
NATURE VERDINO  
with embossing



## Rustic

➤ 138

### Models

PORTA OSLO  
NATURE OSLO  
PORTA VECTOR  
NATURE VECTOR  
PORTA VERTE HOME  
(E, M)

PORTA CRAFT  
✦ NEW

PORTA VIGO  
✦ NEW



## Vertical

➤ 150

### Models

NATURE VECTOR  
NATURE SPACE  
PORTA VECTOR  
PORTA FOCUS  
PREMIUM  
PORTA LINE  
PORTA FOCUS

Porta RESIST  
PORTA LOFT  
NATURE LINE



## Glass

➤ 162

### Models

STEEL PORTA LOFT  
PORTA LUMIA  
PORTA GLASS

Timeless style with  
a modern twist



# Modern Classic

The cherished style of old townhouses adapted to modern interiors. This design line is distinguished by glazing without muntins and calm, classic shades of wood and varnishes. It is also available in an elegant Glamour version, which is ideal for premium interiors.



PORTA HARMONY

Check [➤](#) 32



PORTA GRANDE

Check [➤](#) 34

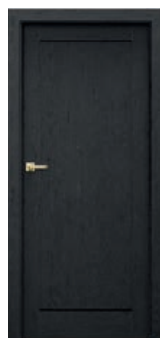

NATURE GRANDE

Check [➤](#) 34



PORTA IMPERIAL

Check [➤](#) 36



PORTA ORNATO

Check [➤](#) 38



AIR

Check [➤](#) 40



PORTA BALANCE

Check [➤](#) 42



PORTA CLASSIC HOME

Check [➤](#) 44

## Additional options



Higher

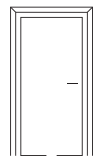

Decorative mouldings / architraves [➤](#) 210

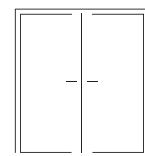

Double leaf

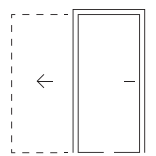

Sliding [➤](#) 170

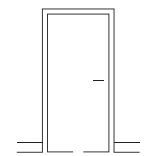

Skirting boards in many colours [➤](#) 231

[➤](#) You can find more modification options on the pages with certain collection.

## Matching the Modern Classic line

See all door handles and knobs [➤](#) 190

### Handles



Moderno



Lungo

### Knobs



Nobile



Caldo

Check out the design lines on the website.



# PORTA HARMONY

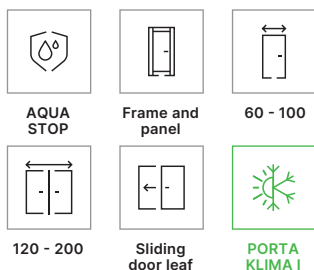

## Recommended door frames

### Rebated door frames:

- PORTA SYSTEM **HYDRO PROTECT™**
- PORTA SYSTEM
- PORTA SYSTEM 90°
- MINIMAX

### Non-rebated door frames:

- PORTA SYSTEM ELEGANCE **HYDRO PROTECT™**
- PORTA SYSTEM ELEGANCE
- PORTA SYSTEM ELEGANCE 90°
- LEVEL

### Door frames with reverse rebate:

- PORTA SYSTEM with reverse rebate

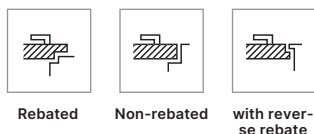

## Notes

- PN EN 14351-2 standard.
- Double doors are available in any door leaf size combinations.
- Magnetic lock is not available for a double door.
- In double non-rebated doors, there are two, active and passive, leaves in sizes from '60' to '100'.
- The lower surface of stiles are protected against humidity thanks to TechnoPORTA AQUA STOP.



## Construction

Door leaves contain rails and stiles, slim panels and 4 mm thick, frosted, tempered glass. Combination of those depends on a model. Preparation for shortening (maximum 30 mm). Size '100' requires third hinge.

This door belongs to design line



Modern Classic



## Accessories

Learn more [↗](#) 190

Check on the website



Lungo handle



fancy profiled panel



Finishes

See larger visualisations [➤](#) 252

(1) Uni Colours



White Grey Fjord Olive

(1) Traditional

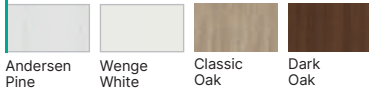

Andersen Pine Wenge White Classic Oak Dark Oak

(2) Uni Colours



White Cashmere Grey Fjord Olive

(2) Modern



Salvador Bleached Oak Salvador Light Oak Natural Arles Oak Toffe Arles Oak Dark Arles Oak Havana Oak

**PLEASE** The number in brackets, e.g. (1) is the finish group

**NOTE!** Check the back cover flap

Additionally

size '100'

ventilation undercut

acoustic threshold 'drop' seal

rebated: PRIME hinges (extra charge to the door frame price)

rebated: key lock and barrel hinges, black or gold colour

rebated: magnetic lock and barrel hinges, black or gold colour

rebated and non-rebated: magnetic lock with stainless steel faceplate

non-rebated: black, white, or gold magnetic lock

non-rebated: third 3D hinge (additional charge to the door frame price)

non-rebated: 3D hinges, gold colour (extra charge to the door frame price)

reverse rebate - extra charge added to door leaf price

reverse rebate - third 3D hinge (extra charge to door frame price)

reverse rebate - 3D hinges, gold colour (extra charge to door frame price)

sliding doors - oblong pull handle

sliding doors - hook lock with side pull handles

# PORTA GRANDE, NATURE GRANDE



Frame and panel

Mirror

220

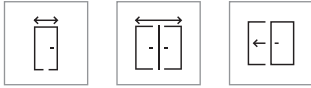

60 - 100

120 - 200

Sliding door leaf



PORTA KLIMA I

## Recommended door frames

### Rebated door frames:

- PORTA SYSTEM **HYDRO PROTECT™** (PORTA GRANDE)
- PORTA SYSTEM
- PORTA SYSTEM 90°

### Non-rebated door frames:

- PORTA SYSTEM ELEGANCE **HYDRO PROTECT™** (PORTA GRANDE)
- PORTA SYSTEM ELEGANCE
- PORTA SYSTEM ELEGANCE 90°
- LEVEL (PORTA GRANDE)

### Door frames with reverse rebate:

- PORTA SYSTEM with reverse rebate



Rebated

Non-rebated

with reverse rebate

## Notes

- PN EN 14351-2 standard.
- Double doors are available in any door leaf size combinations.
- Magnetic lock is not available for a double door.
- In double non-rebated doors, there are two, active and passive, leaves in sizes from '60' to '100'.



PORTA GRANDE A.1 with grooved glass pane, Cashmere, Azura Gold handle

## Construction

Frame and panel construction. The door leaves, depending on the design, consist of horizontal frames and 6 mm thick laminated safety frosted glass. The panels are 6 mm thick, and in model A.0 of PORTA GRANDE, they are 12 mm thick. Preparation for shortening maximum 60 mm. Size '100' requires third hinge. Height '220' - 3 hinges as standard.

This door belongs to design line



## Modern Classic



### Accessories

Learn more [↗](#) 190

Check on the website

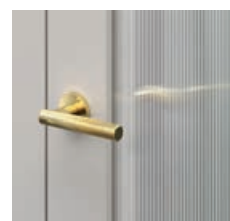

Azura door handle, grooved glass pane in model A.1



mirror - option available for A.1 model

## PORTA GRANDE



A.0

A.1

C.0

## NATURE GRANDE



A.0

A.1

C.0

### Details

It is possible to produce model A.1 with mirror on one or on both sides. If a mirror is only on one side, there is a solidboard on the other side. It is possible to change the glass to transparent tempered 6 mm or, in model A.1, for an additional charge, to tempered grooved 6 mm glass.

### Finishes

See larger visualisations → 252

#### PORTA GRANDE:

##### Premium Plus UV Paint



White

Cashmere

Grey

Sage

#### NATURE GRANDE:

##### Natural Veneer



Oak 1

##### Natural Veneer Select Matte



Oak

Dark Walnut

##### Natural Oak Satin Veneer



Light Oak

Winchester Oak

Tabacco

Brown Oak

Mocca

##### Natural Veneer Uni



White Oak

Black

### Additionally

size '100'

door leaf height '220'

ventilation undercut

acoustic threshold 'drop' seal

grooved glass panel - model A.1

mirror on both sides

mirror on one side

Natural veneer, White Oak, Satin

Natural veneer, Select: Black

rebated: key lock and barrel hinges, black or gold colour

rebated: magnetic lock and barrel hinges, black or gold colour

rebated and non-rebated: magnetic lock with stainless steel faceplate

non-rebated: black, white, or gold magnetic lock

non-rebated: third 3D hinge (additional charge to the door frame price)

non-rebated: 3D hinges, gold colour (extra charge to the door frame price)

reverse rebate - extra charge added to door leaf price

reverse rebate - third 3D hinge (extra charge to door frame price)

reverse rebate - 3D hinges, gold colour (extra charge to door frame price)

sliding doors - oblong pull handle

sliding doors - hook lock with side pull handles

# PORTA IMPERIAL



Frame and panel



220



60 - 100



120 - 200



Sliding door leaf



PORTA KLIMA I

## Recommended door frames

### Rebated door frames:

- PORTA SYSTEM **HYDRO PROTECT™**
- PORTA SYSTEM
- PORTA SYSTEM 90°

### Non-rebated door frames:

- PORTA SYSTEM ELEGANCE **HYDRO PROTECT™**
- PORTA SYSTEM ELEGANCE
- PORTA SYSTEM ELEGANCE 90°
- LEVEL

### Door frames with reverse rebate:

- PORTA SYSTEM with reverse rebate



Rebated



Non-rebated



with reverse rebate

## Notes

- PN EN 14351-2 standard.
- Double doors are available in any door leaf size combinations.
- Magnetic lock is not available for a double door.
- In double non-rebated doors, there are two, active and passive, leaves in sizes from '60' to '100'.



PORTA IMPERIAL I.1, Cashmere, Imperial decorative slat next to the door frame, Moderno Black handle

## Construction

Frame and panel construction. The door leaves feature 6 mm thick panels and decorative frames. Preparation for shortening maximum 60 mm. Size '100' requires third hinge. Height '220' - 3 hinges as standard.

This door belongs to design line



Modern Classic



## Accessories

Learn more [↗](#) 190

Check on the website



MODERNO handle



fancy decorative frame



doors with a decorative slat IMPERIAL

## PLEASE NOTE



**PAY ATTENTION TO THE DETAILS**

Check the decorative slats for the door frame [➔ 210](#)



I.1



I.2



I.3

### Finishes

See larger visualisations [➔ 252](#)

#### (2) Uni Colours



#### Premium Plus UV Paint



**PLEASE NOTE!** The number in brackets, e.g. (1) is the finish group  
Check the back cover flap

### Additionally

size '100'

door leaf height '220'

ventilation undercut

acoustic threshold 'drop' seal

rebated: PRIME hinges (extra charge to the door frame price)

rebated: key lock and barrel hinges, black or gold colour

rebated and non-rebated: magnetic lock with stainless steel faceplate

non-rebated: black, white, or gold magnetic lock

rebated: magnetic lock and barrel hinges, black or gold colour

non-rebated: third 3D hinge (additional charge to the door frame price)

non-rebated: 3D hinges, gold colour (extra charge to the door frame price)

reverse rebate - extra charge added to door leaf price

reverse rebate - third 3D hinge (extra charge to door frame price)

reverse rebate - 3D hinges, gold colour (extra charge to door frame price)

sliding doors - oblong pull handle

sliding doors - hook lock with side pull handles

# PORTA ORNATO



Frame and panel



220



60 - 100



120 - 200



Sliding door leaf



PORTA KLIMA I

## Recommended door frames

### Rebated door frames:

- PORTA SYSTEM **HYDRO PROTECT™**
- PORTA SYSTEM
- PORTA SYSTEM 90°

### Non-rebated door frames:

- PORTA SYSTEM ELEGANCE **HYDRO PROTECT™**
- PORTA SYSTEM ELEGANCE
- PORTA SYSTEM ELEGANCE 90°
- LEVEL

### Door frames with reverse rebate:

- PORTA SYSTEM with reverse rebate



Rebated



Non-rebated



with reverse rebate

## Notes

- PN EN 14351-2 standard.
- Double doors are available in any door leaf size combinations.
- Magnetic lock is not available for a double door.
- In double non-rebated doors, there are two, active and passive, leaves in sizes from '60' to '100'.



PORTA ORNATO O.1, White, Ornato decorative slat on the door frame, Lungo Black handle

## Construction

Frame and panel construction. The door leaves feature 6 mm thick panels and decorative frames. Preparation for shortening maximum 60 mm. Size '100' requires third hinge. Height '220' - 3 hinges as standard.

This door belongs to design line



Modern Classic



## Accessories

Learn more [↗](#) 190

Check on the website



LUNGO handle



fancy decorative frame



Ornato door with the decorative slat

## PLEASE NOTE



PAY ATTENTION TO THE DETAILS

Check the decorative slats for the door frame [➔ 210](#)



O.1



O.2

### Finishes

See larger visualisations [➔ 252](#)

#### (2) Uni Colours



#### Premium Plus UV Paint



**PLEASE NOTE!** The number in brackets, e.g. (1) is the finish group  
Check the back cover flap

### Additionally

size '100'

door leaf height '220'

ventilation undercut

acoustic threshold 'drop' seal

rebated: PRIME hinges (extra charge to the door frame price)

rebated: key lock and barrel hinges, black or gold colour

rebated: magnetic lock and barrel hinges, black or gold colour

rebated and non-rebated: magnetic lock with stainless steel faceplate

non-rebated: black, white, or gold magnetic lock

non-rebated: third 3D hinge (additional charge to the door frame price)

non-rebated: 3D hinges, gold colour (extra charge to the door frame price)

reverse rebate - extra charge added to door leaf price

reverse rebate - third 3D hinge (extra charge to door frame price)

reverse rebate - 3D hinges, gold colour (extra charge to door frame price)

sliding doors - oblong pull handle

sliding doors - hook lock with side pull handles

# AIR

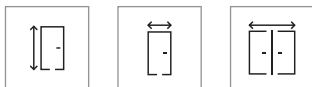

220

60 - 100

120 - 200



PORTA  
KLIMA II\*

\* possibility of  
changing the class  
from PORTA KLIMA I  
to PORTA KLIMA II,  
see page 4

## Recommended door frames

### Rebated door frames:

- PORTA SYSTEM **HYDRO PROTECT™**
- PORTA SYSTEM
- PORTA SYSTEM 90°

### Non-rebated door frames:

- PORTA SYSTEM ELEGANCE  
**HYDRO PROTECT™**
- PORTA SYSTEM ELEGANCE

### Door frames with reverse rebate:

- PORTA SYSTEM with reverse rebate



Rebated



Non-rebated

with rever-  
se rebate

## Notes

- PN EN 14351-2 standard.
- Models P.2 and P.3 in reverse rebate version are available for order with a frame in ranges B and C.
- Recuperative shortcut available in Premium Plus UV paint finish.
- Double doors are available in any door leaf size combinations.
- Magnetic lock is not available for a double door.
- In double non-rebated doors, there are two, active and passive, leaves in sizes from '60' to '100'.



AIR P.3, height '220', Fjord, Nobile Black knob

## Construction

Hollow chipboard core reinforced with rails and stiles. The construction is skinned with HDF. Preparation for shortening (maximum 60 mm).

This door belongs  
to design line



## Modern Classic



### Accessories

Learn more [↗](#) 190

Check on  
the website



Nobile knob

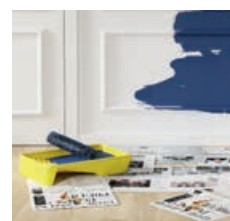

option finished with  
white primer veneer, for  
self-painting

## Tip



### DESIGNED AS A SET

with wall mouldings and Nobile knob



P.2 height 220



P.3 height 220

## Finishes

See larger visualisations [➤](#) 252

### FOR DIY PAINTING:

#### Primer



Veneer

#### Premium Plus UV Paint



White

#### (2) Uni Colours



White

Cashmere

Grey

Fjord

Olive

**PLEASE** The number in brackets, e.g. (1) is the finish group

**NOTE!** Check the back cover flap

## Additionally

size '100'

door leaf height '220'

NEW garage set: see page 240

ventilation undercut or recuperative shortcut

acoustic threshold 'drop' seal

rebated: replacement of a key lock with a different colour

rebated and non-rebated: replacement the silver magnetic lock with a different colour

non-rebated: third 3D hinge in silver, black or gold (extra charge to the door frame price)

non-rebated: 3D hinges, gold colour (extra charge to the door frame price)

reverse rebate - extra charge added to door leaf price

reverse rebate - third 3D hinge, silver, black, or gold colour (extra charge to door frame price)

reverse rebate - 3D hinges, gold colour (extra charge to door frame price)

# PORTA BALANCE

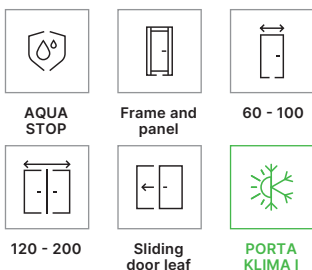

## Recommended door frames

### Rebated door frames:

- PORTA SYSTEM **HYDRO PROTECT™**
- PORTA SYSTEM
- PORTA SYSTEM 90°
- MINIMAX

### Non-rebated door frames:

- PORTA SYSTEM ELEGANCE **HYDRO PROTECT™**
- PORTA SYSTEM ELEGANCE
- PORTA SYSTEM ELEGANCE 90°
- LEVEL

### Door frames with reverse rebate:

- PORTA SYSTEM with reverse rebate

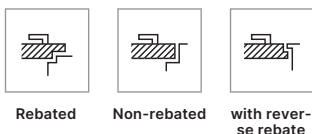

## Notes

- PN EN 14351-2 standard.
- Double doors are available in any door leaf size combinations.
- Magnetic lock is not available for a double door.
- In double non-rebated doors, there are two, active and passive, leaves in sizes from '60' to '100'.
- The lower surface of stiles are protected against humidity thanks to TechnoPORTA AQUA STOP.



## Construction

Door leaves contain rails and stiles, slim panels and 4 mm thick, frosted, tempered glass. Combination of those depends on a model. Preparation for shortening (maximum 30 mm). Size '100' requires third hinge.

This door belongs to design line



Modern Classic



## Accessories

Learn more [↗](#) 190

Check on the website



fancy profiled panel



A.0

B.0

B.1

## Finishes

See larger visualisations [➤](#) 252

### (1) Uni Colours



White Grey Fjord Olive

### (1) Traditional

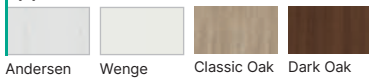

Andersen Pine Wenge White Classic Oak Dark Oak

### (2) Uni Colours



White Cashmere Grey Fjord Olive

### (2) Modern



Salvador Bleached Oak Salvador Light Oak Natural Arles Oak Toffe Arles Oak Dark Arles Oak Havana Oak

**PLEASE** The number in brackets, e.g. (1) is the finish group  
**NOTE!** Check the back cover flap

## Additionally

size '100'

ventilation undercut

acoustic threshold 'drop' seal

rebated: PRIME hinges (extra charge to the door frame price)

rebated: key lock and barrel hinges, black or gold colour

rebated: magnetic lock and barrel hinges, black or gold colour

rebated and non-rebated: magnetic lock with stainless steel faceplate

non-rebated: black, white, or gold magnetic lock

non-rebated: third 3D hinge (additional charge to the door frame price)

non-rebated: 3D hinges, gold colour (extra charge to the door frame price)

reverse rebate - extra charge added to door leaf price

reverse rebate - third 3D hinge (extra charge to door frame price)

reverse rebate - 3D hinges, gold colour (extra charge to door frame price)

sliding doors - oblong pull handle

sliding doors - hook lock with side pull handles

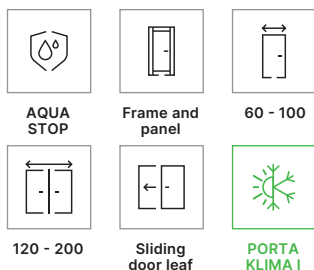

### Recommended door frames

#### Rebated door frames:

- PORTA SYSTEM **HYDRO PROTECT™**
- PORTA SYSTEM
- PORTA SYSTEM 90°
- MINIMAX
- STEEL DOOR FRAMES

#### Non-rebated door frames:

- PORTA SYSTEM ELEGANCE **HYDRO PROTECT™**
- PORTA SYSTEM ELEGANCE
- PORTA SYSTEM ELEGANCE 90°
- LEVEL

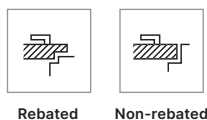

### Notes

- PN EN 14351-2 standard.
- Double doors are available in any door leaf size combinations.
- Magnetic lock is not available for a double door.
- In double non-rebated doors, there are two, active and passive, leaves in sizes from '60' to '100'.
- The lower surface of stiles are protected against humidity thanks to TechnoPORTA AQUA STOP.

# PORTA CLASSIC HOME



### Construction

Door leaves contain rails and stiles, slim panels or 4 mm thick, frosted, tempered glass panes. Combination of those depends on a model. In model A.0, the slim panel is 12 mm thick. Preparation for shortening (maximum 30 mm). Size '100' requires third hinge.

This door belongs to design line



Modern Classic



### Accessories

Learn more [↗](#) 190

Check on the website



Lago handle, frosted glass



muntins, 25 wide (models C.1, C.2), glued to the glass pane



**Details**

Transparent glass pane available in models A.1 and C.1. Model A.1 is also available with glass pane with painted muntins (not available for sliding doors). The width of the painted muntins is 25 mm, they are single-sided. Model A.0 can be ordered with a black magnetic board for drawing with chalk markers (board on one side, only rebated option up to size 90. 90). Muntins in models C.1, C.2 - glued to the glass, 30 mm wide.

**Finishes**

See larger visualisations → 252

**(1) Uni Colours**



White Grey Fjord Olive

**(1) Traditional**



Wenge White Classic Oak Dark Oak

**(2) Uni Colours**



White Cashmere Grey

**(2) Modern**



Salvador Bleached Oak Salvador Light Oak Natural Arles Oak Toffe Arles Oak

**(2) Traditional**



Dark Arles Oak Havana Oak Matte Oak Natural Oak Dark Matte Oak

**PLEASE** The number in brackets, e.g. (1) is the finish group

**NOTE!** Check the back cover flap

**Additionally**

size '100'

transparent painted glass

transparent glass

blackboard on one side

ventilation undercut

acoustic threshold 'drop' seal

rebated: PRIME hinges (extra charge to the door frame price)

rebated: key lock and barrel hinges, black or gold colour

rebated: magnetic lock and barrel hinges, black or gold colour

rebated and non-rebated: magnetic lock with stainless steel faceplate

non-rebated: black, white, or gold magnetic lock

non-rebated: third 3D hinge (additional charge to the door frame price)

non-rebated: 3D hinges, gold colour (extral charge to the door frame price)

sliding doors - oblong pull handle

sliding doors - hook lock with side pull handles

Traditional design  
that never goes out  
of style



PORTA VERRO V.1, White, LINEO decorative slat next to the door frame, golden matte LAGO handle

# Classic

A proven design for lovers of tradition. A design line based on classic divisions and proportions, inspired by old styles. The distinctive glazing with muntins is accompanied by classic finishes such as white and warm wood shades and browns.



MADRID

Check [➤ 48](#)



CORDOBA

Check [➤ 48](#)



PORTA VERRO

Check [➤ 50](#)



SEVILLE

Check [➤ 52](#)



PORTA INSPIRE

Check [➤ 54](#)



PORTA NOVA

Check [➤ 56](#)



PORTA VECTOR PREMIUM

Check [➤ 58](#)



PORTA FACTOR

Check [➤ 58](#)



PORTA ROYAL

Check [➤ 60](#)



LONDON

Check [➤ 62](#)



VIENNA

Check [➤ 62](#)

Detailed offer also available at [www.portadoors.com](http://www.portadoors.com)

## Additional options



Higher

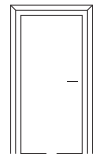

Decorative mouldings / architraves [➤ 210](#)

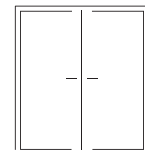

Double leaf

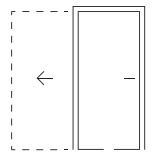

Sliding [➤ 170](#)

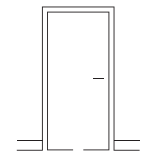

Skirting boards in many colours [➤ 231](#)

[➤](#) You can find more modification options on the pages with certain collection.

## Matching to the Classic line

See all door handles and knobs [➤ 190](#)

### Handles



Eleganto



Segura



Organic



Fresco

Check out the design lines on the website.



# MADRID, CORDOBA

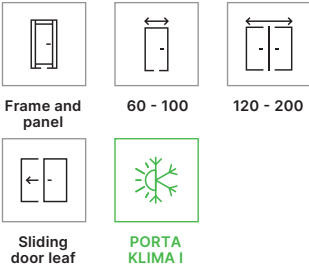

## Recommended door frames

### Rebated door frames:

- PORTA SYSTEM
- PORTA SYSTEM 90°

### Non-rebated door frames:

- PORTA SYSTEM ELEGANCE
- PORTA SYSTEM ELEGANCE 90°

### Door frames with reverse rebate:

- PORTA SYSTEM with reverse rebate



## Notes

- PN EN 14351-2 standard.
- Double doors are available in any door leaf size combinations.
- Magnetic lock is not available for a double door.
- Passive leaf sizes: from '60' to '100', or size '40' (side panel).
- In non-rebated double door leaves, there are two leaves: active and passive in sizes '60' ÷ '100'.



CORDOBA, large muntin, side panel model K, Tabacco Oak, Floro silver handle

## Construction

Glued laminated softwood with MDF. Thanks to applied technology, door leaf is very resistant to deformations. Rails and stiles of Cordoba are chamfered with 20°. Preparation for shortening maximum 60 mm. Door leaf with a ventilation slit - shortening up to 40 mm.

This door belongs to design line



Classic



## Accessories

Learn more [↗](#) 190

Check on the website

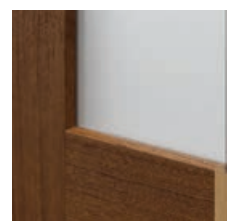

CORDOBA: minimalist rails and stiles chamfered with 20°

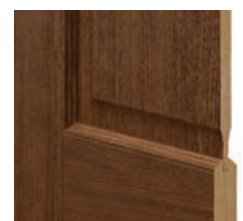

MADRID: decorative profiled panel and rails and stiles

## PLEASE NOTE

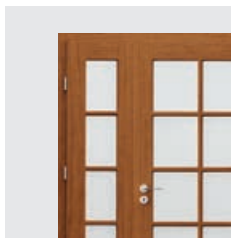

### SIDE PANELS THAT MATCH THE COLLECTION

Check out our offer [↗ 232](#)

## MADRID



solid



small glazing



muntin



large muntin

## CORDOBA



solid



small glazing

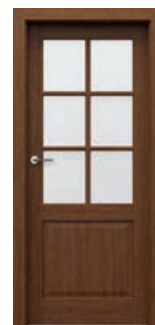

muntin



large muntin

### Details

A door leaf is finished with natural veneer. Surface is protected by ecological waterbased varnishes, veneers (except white) are hardened under UV lamp (semi-matte). Unvarnished door leaves are available in a standard product price. Tempered frosted glass.

### Finishes

See larger visualisations [↗ 252](#)

#### Natural Veneer



Oak 1

#### Natural Oak Satin Veneer



Light Oak



Winchester Oak



Tabacco



Brown Oak



Mocca

#### Natural Veneer Uni



White Oak

### Additionally

size '100'

ventilation undercut

acoustic threshold 'drop' seal

Natural veneer, White Oak, Satin

rebated: key lock and barrel hinges, black or gold colour

rebated: magnetic lock and barrel hinges, black or gold colour

rebated and non-rebated: magnetic lock with stainless steel faceplate

non-rebated: black, white, or gold magnetic lock

non-rebated: third 3D hinge (additional charge to the door frame price)

non-rebated: 3D hinges, gold colour (extra charge to the door frame price)

reverse rebate - extra charge added to door leaf price

reverse rebate - third 3D hinge (extra charge to door frame price)

reverse rebate - 3D hinges, gold colour (extra charge to door frame price)

K an astragal for double-leaf doors

sliding doors - oblong pull handle

sliding doors - hook lock with side pull handles

# PORTA VERRO

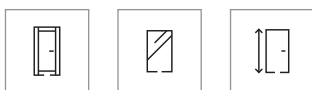

Frame and panel

Mirror

220



60 - 100

120 - 200

Sliding door leaf



PORTA KLIMA I

## Recommended door frames

### Rebated door frames:

- PORTA SYSTEM **HYDRO PROTECT™**
- PORTA SYSTEM
- PORTA SYSTEM 90°

### Non-rebated door frames:

- PORTA SYSTEM ELEGANCE **HYDRO PROTECT™**
- PORTA SYSTEM ELEGANCE
- PORTA SYSTEM ELEGANCE 90°
- LEVEL

### Door frames with reverse rebate:

- PORTA SYSTEM with reverse rebate



Rebated

Non-rebated

with reverse rebate

## Notes

- PN EN 14351-2 standard.
- Double doors are available in any door leaf size combinations.
- Magnetic lock is not available for a double door.
- In double non-rebated doors, there are two, active and passive, leaves in sizes from '60' to '100'.



PORTA VERRO V.1, White, Lineo decorative slat on the door frame, Fioro Gold Matt door handle

## Construction

Frame and panel construction. The door leaves, depending on the design, are made of horizontal stiles and 6 mm thick frosted laminated safety glass. The panel in model V.2 is 6 mm thick. Muntins are 30 mm wide. Preparation for shortening maximum 60 mm. Size '100' requires third hinge. Height '220' - 3 hinges as standard.

This door belongs to design line



## Classic

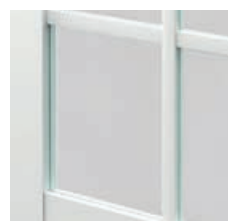

close-up of muntins



door set with LINEO decorative slat



## Accessories

Learn more [↗](#) 190

Check on the website



## PLEASE NOTE



### PAY ATTENTION TO THE DETAILS

Check the decorative slats for the door frame [➔ 210](#)

### PLEASE NOTE

If you are looking for solid doors that will match this collection, see also PORTA GRANDE collection, models A. [➔ 34](#)



V.1



V.2

### Details

Model V.1 can be made with a mirror on one or both sides. If a mirror is only on one side, there is a slim panel on the other side. It is possible to change the glass to transparent tempered 6 mm.

### Finishes

See larger visualisations [➔ 252](#)

#### Premium Plus UV Paint



White

Cashmere

Grey

Sage

### Additionally

size '100'

door leaf height '220'

ventilation undercut

acoustic threshold 'drop' seal

mirror on both sides

mirror on one side

rebated: key lock and barrel hinges, black or gold colour

rebated: magnetic lock and barrel hinges, black or gold colour

rebated and non-rebated: magnetic lock with stainless steel faceplate

non-rebated: black, white, or gold magnetic lock

non-rebated: third 3D hinge (additional charge to the door frame price)

non-rebated: 3D hinges, gold colour (extra charge to the door frame price)

reverse rebate - extra charge added to door leaf price

reverse rebate - third 3D hinge (extra charge to door frame price)

reverse rebate - 3D hinges, gold colour (extra charge to door frame price)

sliding doors - oblong pull handle

sliding doors - hook lock with side pull handles

# SEVILLE

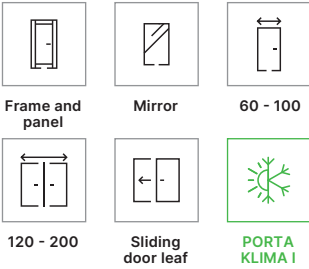

## Recommended door frames

### Rebated door frames:

- PORTA SYSTEM
- PORTA SYSTEM 90°

### Non-rebated door frames:

- PORTA SYSTEM ELEGANCE
- PORTA SYSTEM ELEGANCE 90°

### Door frames with reverse rebate:

- PORTA SYSTEM with reverse rebate



## Notes

- PN EN 14351-2 standard.
- Double doors are available in any door leaf size combinations.
- Magnetic lock is not available for a double door.
- Passive leaf sizes: from '60' to '100', or size '40' (side panel).
- In non-rebated double door leaves, there are two leaves: active and passive in sizes '60' ÷ '100'.



SEVILLA solid, White Oak, Fiore White handle

## Construction

Glued laminated softwood with MDF. Thanks to applied technology, door leaf is very resistant to deformations. Preparation for shortening maximum 60 mm. A door leaf with a ventilation slit - shortening up to 40 mm.

This door belongs to design line



Classic



Fiore handle, decorative profiled panel and rails and stiles



## Accessories

Learn more [↗](#) 190

Check on the website



## PLEASE NOTE



### SIDE PANELS THAT MATCH THE COLLECTION

Check out our offer [↗ 232](#)



solid



with glass pane

### Details

A door leaf is finished with natural veneer. Surface is protected by ecological waterbased varnishes, veneers (except white) are hardened under UV lamp (semi-matte). Unvarnished door leaves are available in a standard product price. Tempered frosted glass. There is a possibility of producing with mirror just one side (there is a board on the other side).

### Finishes

See larger visualisations [↗ 252](#)

#### Natural Veneer



Oak 1

#### Natural Oak Satin Veneer



Light Oak



Winchester Oak



Tabacco



Brown Oak



Mocca

#### Natural Veneer Uni



White Oak

### Additionally

size '100'

mirror on one side

ventilation undercut

acoustic threshold 'drop' seal

Natural veneer, White Oak, Satin

rebated: key lock and barrel hinges, black or gold colour

rebated: magnetic lock and barrel hinges, black or gold colour

rebated and non-rebated: magnetic lock with stainless steel faceplate

non-rebated: black, white, or gold magnetic lock

non-rebated: third 3D hinge (additional charge to the door frame price)

non-rebated: 3D hinges, gold colour (extral charge to the door frame price)

reverse rebate - extra charge added to door leaf price

reverse rebate - third 3D hinge (extra charge to door frame price)

reverse rebate - 3D hinges, gold colour (extra charge to door frame price)

K an astragal for double-leaf doors

sliding doors - oblong pull handle

sliding doors - hook lock with side pull handles

# PORTA INSPIRE g A

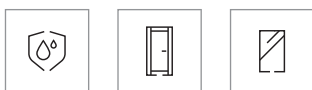

AQUA STOP

Frame and panel

Mirror



60 - 100



120 - 200



Sliding door leaf



PORTA KLIMA I

## Recommended door frames

### Rebated door frames:

- PORTA SYSTEM **HYDRO PROTECT™**
- PORTA SYSTEM
- PORTA SYSTEM 90°

### Non-rebated door frames:

- PORTA SYSTEM ELEGANCE **HYDRO PROTECT™**
- PORTA SYSTEM ELEGANCE
- PORTA SYSTEM ELEGANCE 90°
- LEVEL

### Door frames with reverse rebate:

- PORTA SYSTEM with reverse rebate



Rebated



Non-rebated



with reverse rebate

## Notes

- PN EN 14351-2 standard.
- Double doors are available in any door leaf size combinations.
- Magnetic lock is not available for a double door.
- In double non-rebated doors, there are two, active and passive, leaves in sizes from '60' to '100'.
- The lower surface of stiles are protected against humidity thanks to TechnoPORTA AQUA STOP.



PORTA INSPIRE A.0, Wenge White, retro module, Fiore Silver handle

## Construction

Door leaves contain rails and stiles, slim panels and 6 mm thick, frosted, tempered glass with decorative frame. Combination of those depends on a model. Preparation for shortening maximum 60 mm. Size '100' requires third hinge.

This door belongs to design line



## Classic



### Accessories

Learn more [↗](#) 190

Check on the website



FIORO handle



frosted glass 'frame'



3D adjustable barrel hinges

## PLEASE NOTE



### SPECIAL CONSTRUCTION

with glued wood elements  
(option at extra charge)



A.0



A.1

### Details

It is possible to produce model A.1 with mirror on one or on both sides. If a mirror is only on one side, there is a solid board on the other side. Frosted glass 'frame'.

### Finishes

See larger visualisations → 252

#### (1) Traditional



Andersen Pine Wenge White Classic Oak Dark Oak

#### (2) Uni Colours



White

#### (2) Modern



Salvador Bleached Oak Salvador Light Oak Natural Arles Oak Toffe Arles Oak Dark Arles Oak Havana Oak

#### (2) Traditional



Matte Oak Natural Oak California Oak Dark Matte Oak

**PLEASE NOTE!** The number in brackets, e.g. (1) is the finish group  
Check the back cover flap

### Additionally

size '100'

multi-layered wooden construction (vertical stiles)

ventilation undercut

acoustic threshold 'drop' seal

mirror on both sides

mirror on one side

rebated and non-rebated: magnetic lock with stainless steel faceplate

non-rebated: black, white, or gold magnetic lock

non-rebated: third 3D hinge (additional charge to the door frame price)

non-rebated: 3D hinges, gold colour (extra charge to the door frame price)

reverse rebate - extra charge added to door leaf price

reverse rebate - third 3D hinge (extra charge to door frame price)

reverse rebate - 3D hinges, gold colour (extra charge to door frame price)

sliding doors - oblong pull handle

sliding doors - hook lock with side pull handles

# PORTA NOVA

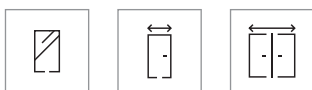

Mirror 60 - 100 120 - 200



Sliding door leaf

PORTA KLIMA II\*

\* possibility of changing the class from PORTA KLIMA I to PORTA KLIMA II, see page 4

## Recommended door frames

### Rebated door frames:

- PORTA SYSTEM **HYDRO PROTECT™**
- PORTA SYSTEM
- PORTA SYSTEM 90°
- MINIMAX
- STEEL DOOR FRAMES

### Non-rebated door frames:

- PORTA SYSTEM ELEGANCE **HYDRO PROTECT™**
- PORTA SYSTEM ELEGANCE
- PORTA SYSTEM ELEGANCE 90°
- LEVEL



Rebated

Non-rebated

## Notes

- PN EN 14351-2 standard.
- Double doors are available in any door leaf size combinations.
- Magnetic lock is not available for a double door.
- Passive leaf sizes: from '60' to '100'. Passive door leaves (side panels) in sizes '30', '40', '50' available only in solid option (without decorative applications).
- In double non-rebated doors, there are two, active and passive, leaves in sizes from '60' to '100'.
- Model 2.2 is not available in size '100'.



PORTA NOVA 2.1, Dark Matte Oak, Simplo Silver handle

## Construction

Chipboard core reinforced with rails and stiles. The construction is skinned with HDF. Size '100' requires third hinge. Preparation for shortening as standard - maximum 60 mm.

This door belongs to design line



## Classic



### Accessories

Learn more [↗](#) 190

Check on the website

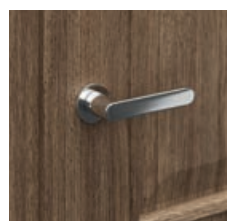

Simplo handle, bead with decorative panel

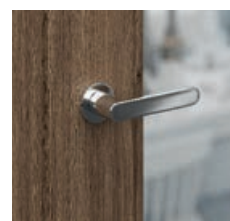

mirror - option available for PORTA NOVA 2.2



**Details**

Model 2.2 is available with a mirror on one or on both sides. If the mirror is only on one side, there will be slim panel on the other side. Glazed models with frosted tempered glass.

**Finishes**

See larger visualisations [➤](#) 252

**(1) Traditional**

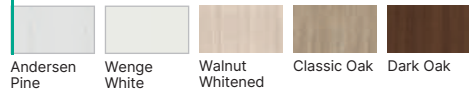

**(2) Traditional**

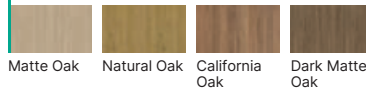

**(1) Rustic**

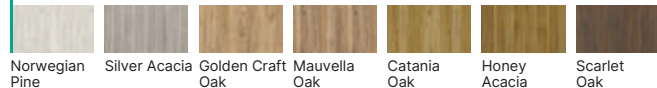

**(2) Rustic**



**PLEASE** The number in brackets, e.g. (1) is the finish group  
**NOTE!** Check the back cover flap

**Additionally**

size '100'

ventilation undercut

acoustic threshold 'drop' seal

mirror on both sides

mirror on one side

rebated: PRIME hinges (extra charge to the door frame price)

rebated: key lock and barrel hinges, black or gold colour

rebated: magnetic lock and barrel hinges, black or gold colour

rebated and non-rebated: magnetic lock with stainless steel faceplate

non-rebated: black, white, or gold magnetic lock

non-rebated: third 3D hinge (additional charge to the door frame price)

non-rebated: 3D hinges, gold colour (extral charge to the door frame price)

sliding doors - oblong pull handle

sliding doors - hook lock with side pull handles

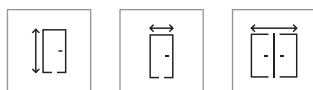

220

60 - 100

120 - 200

Sliding  
door leafPORTA  
KLIMA II+\* possibility of  
changing the class  
from PORTA KLIMA I  
to PORTA KLIMA II,  
see page 4

### Recommended door frames

Door frames finished with Premium Lacquered veneer (PORTA VECTOR PREMIUM, PORTA FACTOR) and Premium Plus UV Paint (PORTA VECTOR PREMIUM):

#### Rebated door frames:

- PORTA SYSTEM **HYDRO PROTECT™**
- PORTA SYSTEM
- PORTA SYSTEM 90°
- MINIMAX

#### Non-rebated door frames:

- PORTA SYSTEM ELEGANCE **HYDRO PROTECT™**
- PORTA SYSTEM ELEGANCE
- PORTA SYSTEM ELEGANCE 90°
- LEVEL

#### Door frames with reverse rebate:

- PORTA SYSTEM with reverse rebate



Rebated



Non-rebated

with rever-  
se rebate

### Notes

- PN EN 14351-2 standard.
- Double doors are available in any door leaf size combinations.
- Magnetic lock is not available for a double door.
- In double non-rebated doors, there are two, active and passive, leaves in sizes from '60' to '100'.

# PORTA VECTOR PREMIUM, PORTA FACTOR



PORTA VECTOR PREMIUM V, White, Lineo decorative slat along the door frame, Lago gold handle

### Construction

Honeycomb or hollow chipboard core reinforced with rails and stiles (at extra charge). The construction is skinned with HDF. Chipboard core have preparation for shortening as standard. Height '220' comes with hollow chipboard core and 3 hinges as standard. Size '100' requires third hinge.

This door belongs  
to design line



### Classic



decorative milling close-up



### Accessories

Learn more → 190

Check on  
the website





Finishes

See larger visualisations → 252

PORTA VECTOR PREMIUM:

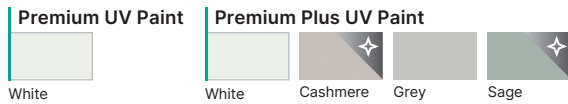

PORTA FACTOR:

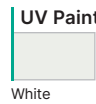

Additionally

- size '100'
- door leaf height '220'
- NEW garage set: see page 240
- ventilation undercut or recuperative shortcut
- hollow chipboard core
- chipboard core
- acoustic threshold 'drop' seal
- SPECIAL OFFER - acoustic package
- rebated: PRIME hinges (extra charge to the door frame price)
- rebated: key lock and barrel hinges, black or gold colour

- rebated: magnetic lock and barrel hinges, black or gold colour
- rebated and non-rebated: magnetic lock with stainless steel faceplate
- non-rebated: black, white, or gold magnetic lock
- non-rebated: third 3D hinge (additional charge to the door frame price)
- non-rebated: 3D hinges, gold colour (extra charge to the door frame price)
- reverse rebate - extra charge added to door leaf price
- reverse rebate - third 3D hinge (extra charge to door frame price)
- reverse rebate - 3D hinges, gold colour (extra charge to door frame price)
- sliding doors - oblong pull handle
- sliding doors - hook lock with side pull handles

# PORTA ROYAL

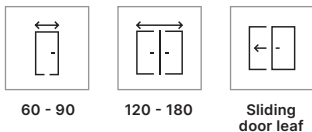

PORTA KLIMA I

## Recommended door frames

### Rebated door frames:

- PORTA SYSTEM **HYDRO PROTECT™**
- PORTA SYSTEM
- PORTA SYSTEM 90°
- MINIMAX

### Non-rebated door frames:

- PORTA SYSTEM ELEGANCE **HYDRO PROTECT™**
- PORTA SYSTEM ELEGANCE
- PORTA SYSTEM ELEGANCE 90°
- LEVEL



Rebated



Non-rebated

## Notes

- PN EN 14351-2 standard.
- Double doors are available in any door leaf size combinations.
- Magnetic lock is not available for a double door.
- In double non-rebated doors, there are two, active and passive, leaves in sizes from '60' to '100'.



PORTA ROYAL A, White, Doro silver handle

## Construction

Stabilising infill or hollow chipboard core (optionally at extra charge) skinned with embossed HDF.

This door belongs to design line



Classic



decorative embossing



## Accessories

Learn more [↗](#) 190

Check on the website





A



P

## Finishes

See larger visualisations [➔](#) 252

### Premium Paint



White

## Additionally

chipboard core

ventilation undercut or recuperative shortcut

acoustic threshold 'drop' seal

rebated: PRIME hinges (extra charge to the door frame price)

rebated: key lock and barrel hinges, black or gold colour

rebated: magnetic lock and barrel hinges, black or gold colour

rebated and non-rebated: magnetic lock with stainless steel faceplate

non-rebated: black, white, or gold magnetic lock

non-rebated: third 3D hinge (additional charge to the door frame price)

non-rebated: 3D hinges, gold colour (extral charge to the door frame price)

sliding doors - oblong pull handle

sliding doors - hook lock with side pull handles

# LONDON, VIENNA



60 - 90



120 - 180



Sliding door leaf



PORTA KLIMA I

## Recommended door frames

### Rebated door frames

finished with Portadecor veneer or Premium Lacquered veneer (LONDON):

- PORTA SYSTEM **HYDRO PROTECT™**
- PORTA SYSTEM
- PORTA SYSTEM 90°
- MINIMAX



Rebated

## Notes

- PN EN 14351-2 standard.
- Double doors are available in any door leaf size combinations.
- Magnetic lock is not available for a double door.
- Due to various materials use, there might be a slight colour difference between door leaf and a glazing bead.



VIENNA B, White, Doro silver matte handle

## Construction

Stabilising infill skinned with embossed HDF.

This door belongs to design line



Classic



## Accessories

Learn more [↗](#) 190

Check on the website



LONDON, VIENNA: wood grains (paint)



LONDON: smooth surface (Premium Paint)

LONDON



P



O



B



C

VIENNA



P



O



B



C

## Finishes

See larger visualisations [➔](#) 252

### Applies to both models:

#### Paint



White

### Only for LONDON:

#### Premium Paint



White

## Additionally

ventilation undercut or recuperative shortcut

rebated: PRIME hinges (extra charge to the door frame price)

rebated: key lock and barrel hinges, black or gold colour

rebated: magnetic lock and barrel hinges, black or gold colour

rebated: magnetic lock with stainless steel faceplate

sliding doors - oblong pull handle

sliding doors - hook lock with side pull handles

# The essence of minimalism and functionality



PORTA VECTOR PREMIUM T, White, Lago black handle

# Basic Home

The essence of minimalism. Smooth flush doors without any decorative elements. Thanks to their simplicity, they are a versatile base for any interior. The pure form of the Basic Home design line represents the very popular modernist style.



NATURE CLASSIC

Check [➤ 66](#)

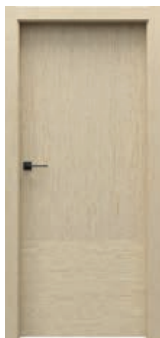

NATURE VERDINO

Check [➤ 68](#)



EARTH

Check [➤ 68](#)



PORTA LEVEL

Check [➤ 70](#)



PORTA VECTOR PREMIUM

Check [➤ 72](#)



PORTA FACTOR

Check [➤ 74](#)



PORTA DECOR

Check [➤ 76](#)



PORTA CPL

Check [➤ 76](#)



PORTA RESIST

Check [➤ 76](#)



PORTA LOFT

Check [➤ 78](#)



FIRE

Check [➤ 78](#)

Detailed offer also available at [www.portadoors.com](http://www.portadoors.com)

## Additional options



Higher

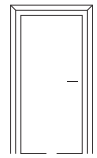

Decorative slats  
[➤ 210](#)

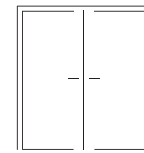

Double leaf

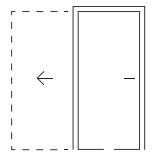

Sliding [➤ 170](#)

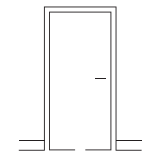

Skirting boards  
in many colours [➤ 231](#)



You can find more modification options on the pages with certain collection.

## Matching the Basic Home line

See all door handles and knobs [➤ 190](#)

### Handles



Finaro



Simple



Fioro



Eleganto

Check out the design lines on the website.



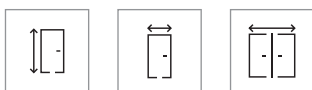

220

60 - 100

120 - 200

Sliding  
door leafPORTA  
KLIMA II\*\* possibility of  
changing the class  
from PORTA KLIMA I  
to PORTA KLIMA II,  
see page 4

### Recommended door frames

#### Rebated door frames:

- PORTA SYSTEM
- PORTA SYSTEM 90°
- STEEL DOOR FRAMES

#### Non-rebated door frames:

- PORTA SYSTEM ELEGANCE
- PORTA SYSTEM ELEGANCE 90°

#### Door frames with reverse rebate:

- PORTA SYSTEM with reverse rebate



Rebated



Non-rebated

with reverse  
rebate

### Notes

- PN EN 14351-2 standard.
- Double doors are available in any door leaf size combinations.
- Magnetic lock is not available for a double door.
- Passive leaf sizes: from '60' to '100'.
- In double non-rebated doors, there are two, active and passive, leaves in sizes from '60' to '100'.

# NATURE CLASSIC



Nature CLASSIC 1.1, Taupe Walnut, black AZURA handle

### Construction

Core - stabilising infill reinforced with rails and stiles. Hollow chipboard core available at an extra charge. Preparation for shortening maximum 60 mm. Height 220 includes hollow chipboard and 3 hinges as a standard.

This door belongs  
to design line



### Basic Home



### Accessories

Learn more [↗](#) 190

Check on  
the website



AZURA handle

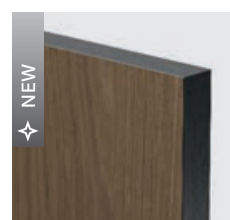

NEW  
✦

there is an option to choose  
black lipping with black  
hinges and a lock



### Details

The construction is skinned with a slim particle board which is finished with high quality natural veneer. The door leaf surface is protected by ecological water-based varnishes. Veneers of groups: Select, Natural Oak, Ash, Walnut and Satin (except of White). are hardened with UV technology. Unvarnished door leaves are available in a standard product price. Model 3.1 is not available with Natural Satin veneer and White Oak. There is an option to pick lipping with choosing Select natural veneer.

### Finishes

See larger visualisations → 252

#### Natural Veneer



Matte Oak    Oak 1    Ash    Walnut

Ash and Walnut veneer is available in the layout - fladder. Only for models 1.1, 3.1.

#### Natural Veneer Select Matte

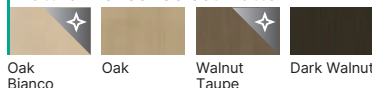

Oak Bianco    Oak    Walnut Taupe    Dark Walnut

#### Natural Oak Satin Veneer

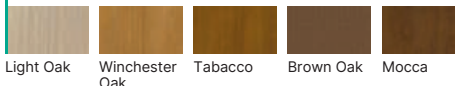

Light Oak    Winchester Oak    Tabacco    Brown Oak    Mocca

#### Natural Veneer Uni



White Oak    Black

### Additionally

size '100'

door leaf height '220'

hollow chipboard core

NEW garage set: see page 240

ventilation undercut or recuperative shortcut

acoustic threshold 'drop' seal

SPECIAL OFFER - acoustic package

rebated: key lock and barrel hinges, black or gold colour

rebated: magnetic lock and barrel hinges, black or gold colour

rebated and non-rebated: magnetic lock with stainless steel faceplate

non-rebated: black, white, or gold magnetic lock

non-rebated: third 3D hinge (additional charge to the door frame price)

non-rebated: 3D hinges, gold colour (extral charge to the door frame price)

reverse rebate - extra charge added to door leaf price

reverse rebate - third 3D hinge (extra charge to door frame price)

reverse rebate - 3D hinges, gold colour (extra charge to door frame price)

sliding doors - oblong pull handle

sliding doors - hook lock with side pull handles

Natural veneer, White Oak, Satin

Natural veneer, Select: Black

Natural matte veneer: Oak, Bianco Oak, Taupe Walnut

Natural Veneer: Ash and Walnut

stainless steel porthole

black porthole



220



60 - 100

Sliding door  
leaf (NATURE  
VERDINO)PORTA  
KLIMA II\*\* possibility of  
changing the class  
from PORTA KLIMA I  
to PORTA KLIMA II,  
see page 4

### Recommended door frames

#### Rebated door frames:

- PORTA SYSTEM (NATURE VERDINO)
- PORTA SYSTEM 90° (NATURE VERDINO)

#### Non-rebated door frames:

- PORTA SYSTEM ELEGANCE
- PORTA SYSTEM ELEGANCE 90°
- LEVEL

#### Door frames with reverse rebate:

- PORTA SYSTEM with reverse rebate

Rebated  
(NATURE  
VERDINO)

Non-rebated

with rever-  
se rebate

### Notes

- PN EN 14351-2 standard.

# NATURE VERDINO, EARTH



EARTH Z.1, height '220', Oak Matte, Fiore black handle

### Construction

NATURE VERDINO: Core - stabilising infill reinforced with rails and stiles. Hollow chipboard core available at an extra charge. EARTH: hollow chipboard core, reinforced with rails and stiles. Preparation for shortening maximum 60 mm. Height '220' comes with hollow chipboard core and 3 hinges as standard.

This door belongs  
to design line



### Basic Home



### Accessories

Learn more [↗](#) 190

Check on  
the website

geometric arrangement  
of natural veneer - model  
EARTH Z.1geometric arrangement of na-  
tural veneer - model NATURE  
VERDINO V.1



### Details

The construction is skinned with a slim particle board which is finished with high quality natural veneer. The surface of the leaf is protected with environmentally friendly UV hardened water-based varnishes (matte).

### Finishes

See larger visualisations [➔](#) 252

#### NATURE VERDINO:

##### Natural Veneer



Matte Oak

##### Natural Veneer Select Matte



Oak Bianco

Walnut Taupe

#### EARTH:

##### Natural Veneer



Matte Oak

### Additionally

#### EXTRA CHARGES TO NATURE VERDINO AND EARTH

size '100'

NEW garage set: see page 240

ventilation undercut or recuperative shortcut

acoustic threshold 'drop' seal

non-rebated: 3D hinges, gold colour (extra charge to the door frame price)

reverse rebate - extra charge added to door leaf price

reverse rebate - 3D hinges, gold colour (extra charge to door frame price)

#### EXTRA CHARGES TO EARTH

door leaf height '220'

rebated and non-rebated: replacement the silver magnetic lock with a different colour

non-rebated: third 3D hinge in silver, black or gold (extra charge to the door frame price)

#### EXTRA CHARGES TO NATURE VERDINO

door leaf height '220'

hollow chipboard core

SPECIAL OFFER - acoustic package

rebated: key lock and barrel hinges, black or gold colour

rebated: magnetic lock and barrel hinges, black or gold colour

rebated and non-rebated: magnetic lock with stainless steel faceplate

non-rebated: black, white, or gold magnetic lock

non-rebated: third 3D hinge (additional charge to the door frame price)

reverse rebate - third 3D hinge (extra charge to door frame price)

sliding doors - oblong pull handle

sliding doors - hook lock with side pull handles

NEW

HYDRO PROTECT™

ACOUSTIC PACKAGE



60 - 100



120 - 200



Sliding door leaf



PORTA KLIMA II\*

\* possibility of changing the class from PORTA KLIMA I to PORTA KLIMA II, see page 4

### Recommended door frames

#### Rebated door frames:

- PORTA SYSTEM **HYDRO PROTECT™**
- PORTA SYSTEM
- PORTA SYSTEM 90°
- MINIMAX
- STEEL DOOR FRAMES

#### Non-rebated door frames:

- PORTA SYSTEM ELEGANCE **HYDRO PROTECT™**
- PORTA SYSTEM ELEGANCE
- PORTA SYSTEM ELEGANCE 90°
- LEVEL

#### Door frames with reverse rebate:

- PORTA SYSTEM with reverse rebate



Rebated



Non-rebated



with reverse rebate

### Notes

- PN EN 14351-2 standard.
- Double doors are available in any door leaf size combinations.
- Magnetic lock is not available for a double door.
- Passive leaf sizes: from '60' to '100'. Passive door leaves (side panels) in sizes '30', '40', '50' available only in solid option (without decorative applications).
- In double non-rebated doors, there are two, active and passive, leaves in sizes from '60' to '100'.

# PORTA LEVEL



PORTA LEVEL B.1, Matte Oak, Azura black handle

### Construction

Honeycomb or hollow chipboard core reinforced with rails and stiles (at extra charge). The construction is skinned with HDF. Height '220' comes with hollow chipboard core and 3 hinges as standard. Size '100' requires third hinge.

This door belongs to design line



Basic Home



### Accessories

Learn more [↗](#) 190

Check on the website



## PLEASE NOTE

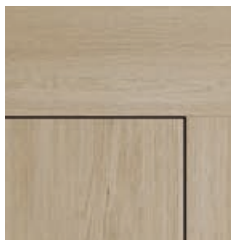

UNUSUAL POSSIBILITIES  
OF INTERIOR DESIGN  
WITH LEVEL DOOR FRAME

LEVEL door frame panel  
is available in heights of 20 cm  
or 100 cm, may have vertical  
or horizontal grain direction



B.1



B.2

## Finishes

See larger visualisations → 252

## (2) Modern

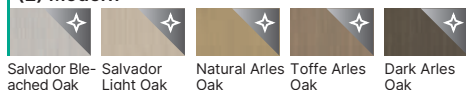

Salvador Bleached Oak Salvador Light Oak Natural Arles Oak Toffe Arles Oak Dark Arles Oak

## (2) Traditional

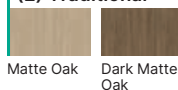

Matte Oak Dark Matte Oak

**PLEASE NOTE!** The number in brackets, e.g. (1) is the finish group  
Check the back cover flap

## Additionally

size '100'

hollow chipboard core

chipboard core

NEW garage set: see page 240

ventilation undercut

acoustic threshold 'drop' seal

SPECIAL OFFER - acoustic package

rebated: key lock and barrel hinges, black or gold colour

rebated: PRIME hinges (extra charge to the door frame price)

rebated: magnetic lock and barrel hinges, black or gold colour

rebated and non-rebated: magnetic lock with stainless steel faceplate

non-rebated: black, white, or gold magnetic lock

non-rebated: third 3D hinge (additional charge to the door frame price)

non-rebated: 3D hinges, gold colour (extra charge to the door frame price)

reverse rebate - extra charge added to door leaf price

reverse rebate - third 3D hinge (extra charge to door frame price)

reverse rebate - 3D hinges, gold colour (extra charge to door frame price)

sliding doors - oblong pull handle

sliding doors - hook lock with side pull handles



220



60 - 100



120 - 200

Sliding  
door leafPORTA  
KLIMA II+

\* possibility of  
changing the class  
from PORTA KLIMA I  
to PORTA KLIMA II,  
see page 4

### Recommended door frames

Door frame finished with Premium  
Lacquered Veneer and Premium Plus  
UV Paint:

#### Rebated door frames:

- PORTA SYSTEM **HYDRO PROTECT™**
- PORTA SYSTEM
- PORTA SYSTEM 90°

#### Non-rebated door frames:

- PORTA SYSTEM ELEGANCE  
**HYDRO PROTECT™**
- PORTA SYSTEM ELEGANCE
- PORTA SYSTEM ELEGANCE 90°
- LEVEL

#### Door frames with reverse rebate:

- PORTA SYSTEM with reverse rebate



Rebated



Non-rebated

with reverse  
rebate

### Notes

- PN EN 14351-2 standard.
- Double doors are available in any door  
leaf size combinations.
- Magnetic lock is not available for  
a double door.
- In double non-rebated doors, there are  
two, active and passive, leaves in sizes  
from '60' to '100'.

# PORTA VECTOR PREMIUM



PORTA VECTOR PREMIUM T, White, Fiore handle, LEVEL door frame

### Construction

Honeycomb or hollow chipboard core reinforced with rails and stiles (at extra charge). The construction is skinned with HDF. Height '220' comes with hollow chipboard core and 3 hinges as standard. Size '100' requires third hinge.

This door belongs  
to design line



Basic Home



porthole with bead in the same  
colour as the door leaf, grooved  
glass pane, also available  
transparent or forsted



### Accessories

Learn more [↗](#) 190

Check on  
the website



## PLEASE NOTE



### GLAZED DOORS MATCHING THE COLLECTION

See the collection  
 PORTA FOCUS PREMIUM  
[➔ 156](#)



T



with porthole

## Finishes

See larger visualisations [➔ 252](#)

### Premium UV Paint



White

### Premium Plus UV Paint



White



Cashmere



Grey



Sage

## Additionally

size '100'

door leaf height '220'

NEW garage set: see page 240

ventilation undercut or recuperative shortcut

hollow chipboard core

chipboard core

acoustic threshold 'drop' seal

SPECIAL OFFER - acoustic package

rebated: PRIME hinges (extra charge to the door frame price)

rebated: key lock and barrel hinges, black or gold colour

rebated: magnetic lock and barrel hinges, black or gold colour

rebated and non-rebated: magnetic lock with stainless steel faceplate

non-rebated: black, white, or gold magnetic lock

non-rebated: third 3D hinge (additional charge to the door frame price)

non-rebated: 3D hinges, gold colour (extra charge to the door frame price)

reverse rebate - extra charge added to door leaf price

reverse rebate - third 3D hinge (extra charge to door frame price)

reverse rebate - 3D hinges, gold colour (extra charge to door frame price)

sliding doors - oblong pull handle

sliding doors - hook lock with side pull handles



220



60 - 100



120 - 200

Sliding  
door leafPORTA  
KLIMA II\*\* possibility of  
changing the class  
from PORTA KLIMA I  
to PORTA KLIMA II,  
see page 4

### Recommended door frames

Door frame finished with synthetic veneer, g 1, or in Premium lacquered veneer:

#### Rebated door frames:

- PORTA SYSTEM **HYDRO PROTECT™**
- PORTA SYSTEM
- PORTA SYSTEM 90°
- MINIMAX
- STEEL DOOR FRAMES

#### Non-rebated door frames:

- PORTA SYSTEM ELEGANCE **HYDRO PROTECT™**
- PORTA SYSTEM ELEGANCE
- PORTA SYSTEM ELEGANCE 90°

#### Door frames with reverse rebate:

- PORTA SYSTEM with reverse rebate



Rebated



Non-rebated

with rever-  
se rebate

### Notes

- Standard PN EN 14351-2:2018-12.
- Double doors are available in any door leaf size combinations.
- Magnetic lock is not available for a double door.
- In double non-rebated doors, there are two, active and passive, leaves in sizes from '60' to '100'.

# PORTA FACTOR



PORTA FACTOR 0, White, Organic black handle

### Construction

Honeycomb or hollow chipboard core reinforced with rails and stiles (at extra charge). The construction is skinned with HDF. Chipboard core have preparation for shortening as standard. Size '100' requires third hinge.

This door belongs  
to design line



Basic Home



### Accessories

Learn more [↗](#) 190

Check on  
the website





## Finishes

See larger visualisations [➔](#) 252

### UV Paint



White

## Additionally

size '100'

door leaf height '220'

NEW garage set: see page 240

ventilation undercut or recuperative shortcut

hollow chipboard core

chipboard core

acoustic threshold 'drop' seal

SPECIAL OFFER - acoustic package

rebated: PRIME hinges (extra charge to the door frame price)

rebated: key lock and barrel hinges, black or gold colour

rebated: magnetic lock and barrel hinges, black or gold colour

rebated and non-rebated: magnetic lock with stainless steel faceplate

non-rebated: black, white, or gold magnetic lock

non-rebated: third 3D hinge (additional charge to the door frame price)

non-rebated: 3D hinges, gold colour (extra charge to the door frame price)

reverse rebate - extra charge added to door leaf price

reverse rebate - third 3D hinge (extra charge to door frame price)

reverse rebate - 3D hinges, gold colour (extra charge to door frame price)

sliding doors - oblong pull handle

sliding doors - hook lock with side pull handles

# PORTA DECOR, PORTA CPL, PORTA RESIST

AQUA  
STOP220 (PORTA  
DECOR AND CPL)

60 - 100



90 - 200

Sliding  
door leafTechnoPORTA  
TechnologyPORTA  
KLIMA II\*

\* possibility of  
changing the class  
from PORTA KLIMA I  
to PORTA KLIMA II,  
see page 4

## Recommended door frames

### Rebated door frames:

- PORTA SYSTEM **HYDRO PROTECT™**
- PORTA SYSTEM
- PORTA SYSTEM 90°
- MINIMAX
- STEEL DOOR FRAMES

### Non-rebated door frames:

- PORTA SYSTEM ELEGANCE **HYDRO PROTECT™**
- PORTA SYSTEM ELEGANCE
- PORTA SYSTEM ELEGANCE 90°
- Steel PORTA SYSTEM ELEGANCE

### Door frames with reverse rebate:

- PORTA SYSTEM with reverse rebate



Rebated



Non-rebated

With reverse  
rebate  
(PORTA CPL,  
RESIST)

## Notes

- Standard PN EN 14351-2:2018-12.
- Height '220' is not available for finishes: Natural Walnut and Lorenzo Oak.
- Magnetic lock is not available for a double door.
- Passive leaf sizes: from '60' to '100'. Passive door leaves (side panels) in sizes '30', '40', '50' available only in solid option (without decorative applications).
- In double non-rebated doors, there are two, active and passive, leaves in sizes from '60' to '100'.
- Lower edge protected against humidity with TechnoPORTA AQUA STOP technology.



## Accessories

Learn more [➔](#) 190



PORTA CPL 1.1 Vicenza Oak, Eleganto black handle

## Construction

Honeycomb or hollow chipboard core reinforced with rails and stiles (at extra charge). The construction is skinned with HDF. There is lipping ABS on the side edges. Chipboard core have preparation for shortening as standard. Size '100' requires third hinge. PORTA DECOR, PORTA CPL: Height '220' includes chipboard core and three hinges. PORTA RESIST: The door leaf is skinned with a 3 mm synchronous structure board, and the door frame is finished with a matching 0.2 mm CPL laminate.

This door belongs  
to design line



## Basic Home

Check on  
the website



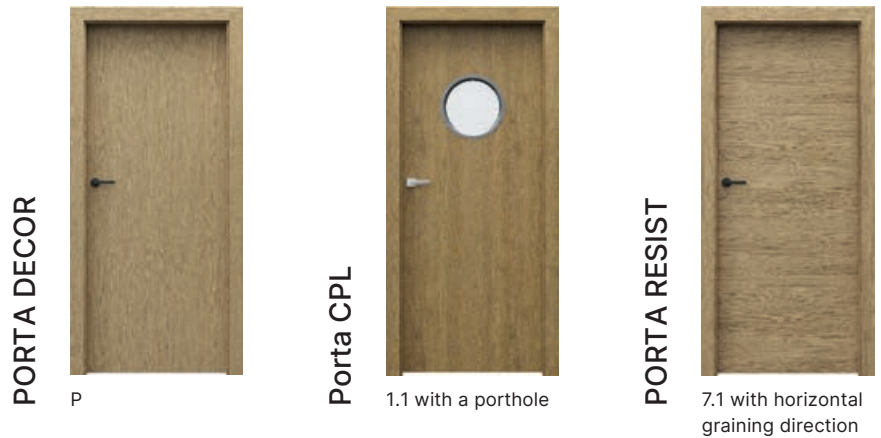

Finishes

See larger visualisations → 252

PORTA DECOR:

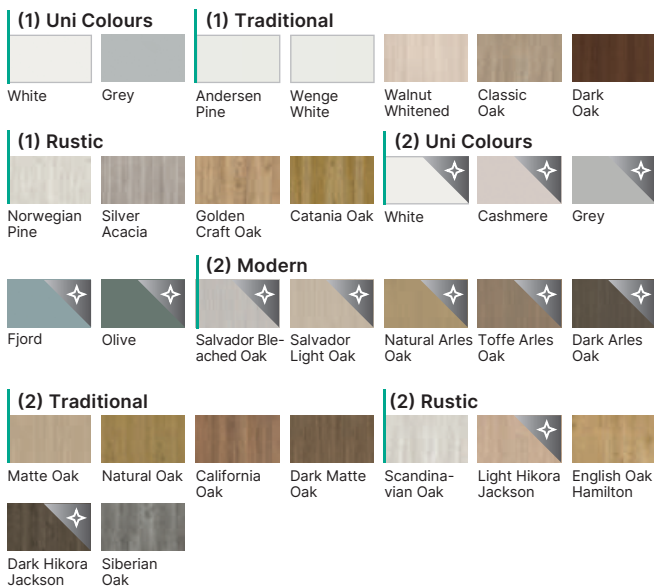

PORTA CPL:

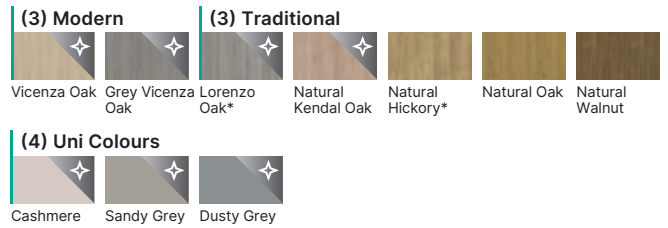

PORTA RESIST:

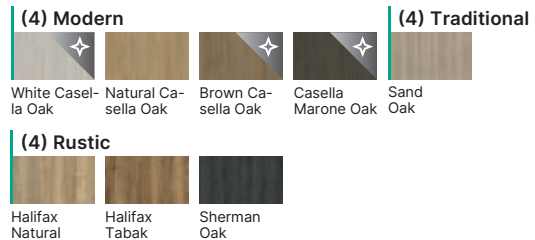

**PLEASE NOTE!** The number in brackets, e.g. (1) is the finish group. Check the back cover flap

Additionally

- size '100'
- door leaf height '220' (PORTA DECOR, PORTA CPL)
- hollow chipboard core
- chipboard core
- NEW garage set: see page 240
- ventilation undercut
- acoustic threshold 'drop' seal
- SPECIAL OFFER - acoustic package
- rebated: PRIME hinges (extra charge to the door frame price)
- rebated: key lock and barrel hinges, black or gold colour
- rebated: magnetic lock and barrel hinges, black or gold colour
- rebated and non-rebated: magnetic lock with stainless steel faceplate

- non-rebated: black, white, or gold magnetic lock
- non-rebated: third 3D hinge (additional charge to the door frame price)
- non-rebated: 3D hinges, gold colour (extral charge to the door frame price)
- sliding doors - oblong pull handle
- sliding doors - hook lock with side pull handles
- ABS lipping, black (PORTA DECOR)
- stainless steel porthole
- black porthole
- CPL 0,2 - marked colours\*
- CPL 0,2 - UNI MATTE GROUP
- reverse rebate - extra charge to the door leaf (2nd finish group UNI COLOURS, 3rd and 4th finish group)
- reverse rebate - third 3D hinge (extra charge to door frame price)
- reverse rebate - 3D hinges, gold colour (extra charge to door frame price)

220  
(FIRE O.1)

60-100

PORTA  
KLIMA II\*

\* possibility of changing the class from PORTA KLIMA I to PORTA KLIMA II, see page 4

### Recommended door frames

#### Black door frames:

#### Non-rebated door frames (PORTA LOFT):

- PORTA SYSTEM ELEGANCE  
HYDRO PROTECT™
- PORTA SYSTEM ELEGANCE
- PORTA SYSTEM ELEGANCE 90°
- Steel PORTA SYSTEM ELEGANCE

#### Non-rebated door frames (FIRE):

- Steel PORTA SYSTEM ELEGANCE

#### Door frames with reverse rebate (PORTA LOFT):

- PORTA SYSTEM with reverse rebate



Non-rebated

With reverse  
rebate (PORTA  
LOFT)

### Notes

- Standard PN EN 14351-2:2018-12.
- Height '220' only available in model O.1.

### Accessories

- Two concealed 3D black hinges.
- PORTA LOFT: key lock or magnetic lock, black.
- FIRE: black key lock for steel door frame.
- FIRE: black magnetic system with door pull option (at extra charge).
- FIRE: additional black lock with magnetic system with the bathroom option (optionally at extra charge).
- With a height of '220,' three hinges are standard.

# PORTA LOFT, FIRE



FIRE O.7 Collection, Sherman Oak, PORTA SYSTEM ELEGANCE steel door frame, Magro handle

### Construction

FIRE: hollow chipboard core reinforced with rails and stiles. PORTA LOFT: honeycomb core or chipboard reinforced with rails and stiles (optionally at extra charge).

The construction is skinned with HDF. Chipboard core has preparation for shortening (maximum 60 mm) as a standard. Size '100' requires third hinge.

This door belongs  
to design line



Basic Home

Check on  
the website



black lipping and  
accessories



CARBON door pull



WC escutcheon with  
additional lock (availa-  
ble for FIRE collection)



**Details**

There is black ABS lipping on door leaf edges. Horizontal grain direction in model 7.1 and 0.7. Black steel panels only in model 0.7.

**Finishes**

See larger visualisations → 252

**PORTA LOFT:**

<p><b>(1) Rustic</b></p> <p>Golden Craft Oak   Mauvella oak   Catania Oak</p>	<p><b>(2) Modern</b></p> <p>Salvador Bleached Oak   Salvador Light Oak   Natural Arles Oak   Toffe Arles Oak</p>
<p><b>(3) Traditional</b></p> <p>Dark Arles Oak   Natural Kendal Oak   Natural Hickory*   Natural Oak</p>	<p><b>(4) Rustic</b></p> <p>Natural Walnut   Halifax Tabak</p>
<p><b>(4) Modern</b></p> <p>White Casella Oak   Natural Casella Oak   Brown Casella Oak</p>	<p><b>(4) Traditional</b></p> <p>Casella Marone Oak   Sand Oak</p>

**FIRE:**

**(4) Rustic**

Sherman Oak

**PLEASE NOTE!**

The number in brackets, e.g. (1) is the finish group  
Check the back cover flap

**Additionally**

**EXTRA CHARGES TO FIRE AND PORTA LOFT**

- size '100'
- NEW garage set: see page 240
- ventilation undercut
- acoustic threshold 'drop' seal
- non-rebated: third 3D hinge , black (extracharge to the door frame price)

**EXTRA CHARGES TO FIRE**

- door leaf height '220'
- magnetic system with a pull: extra charge added to a door frame price
- magnetic system with a pull: extra charge added to a door leaf price
- magnetic system with a door pull: CARBON pull
- magnetic system with a pull: WC escutcheon with an additional lock

**EXTRA CHARGES TO PORTA LOFT**

- hollow chipboard core
- chipboard core
- CPL 0,2 - marked colours\*
- SPECIAL OFFER - acoustic package
- reverse rebate - extra charge added to door leaf price
- reverse rebate - third 3D hinge, black (extra charge to door frame price)

One door  
and thousands of  
possibilities



PORTA HIDE with adhesive panel, Primer paint, next finished with wall paint, Fiore Gunmetal handle

# Hide

Doors that discreetly blend into the background – the door leaf "disappears," concealed in the interior. The smooth surface looks as if it is flush with the wall. The Hide design line offers innovative design and elegant minimalism for modern interiors.

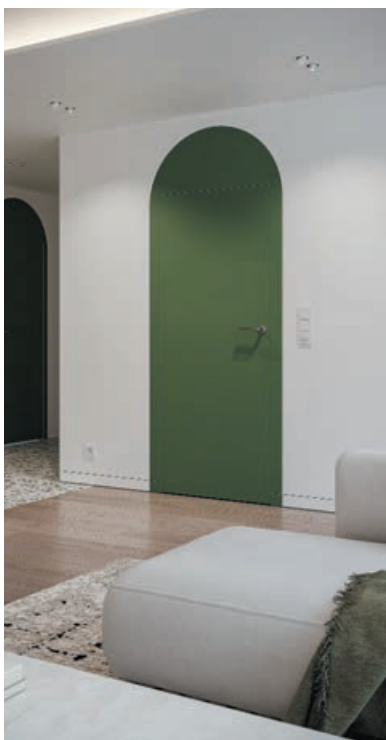

PORTA HIDE

Check

➔ 82



WALL PANELLING

Check

➔ 86

## Additional options



Higher

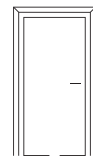

Mouldings  
➔ 210

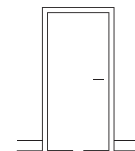

Skirting boards  
in many colours ➔ 231



option for  
further  
painting



option for  
wallpapering



decorate  
with  
mouldings



order  
with natu-  
ral veneer



order with  
synthetic  
veneer



You can find more modification options on the pages with certain collection.

## Matched to the Porta Hide line

See all door handles and knobs ➔ 190

### Handles



Margo



Finaro



Fioro



Simplo

Check out the design lines on the website.





220



60 - 90

PORTA  
KLIMA I

### Recommended door frames

#### Door frame:

- Concealed aluminum frame, unfinished and prepared for painting with wall paint or lacquered in white or black.
- It's dedicated for 40 mm thick, wooden door leaves.
- To be installed on plasterboard wall.



Non-rebated

with reverse  
rebate

#### A door set includes:

- A door leaf.
- Two 3D hinges, dedicated for PORTA HIDE collection, three 3D hinges for hollow chipboard core.
- Magnetic lock: key lock, WC lock or cylinder lock.
- Concealed aluminum door frame.

#### Notes

- PN EN 14351-2 standard.
- Automatic threshold seal is available for a door leaf with hollow chipboard core.
- **Applying panels up to 18 mm is only possible on reinforced doors with reverse rebate (opening inward).**

# PORTA HIDE



PORTA HIDE 1.1, Primer paint, next finished with wall paint, Fiore Gunmetal handle

### Construction

Core: honeycomb or hollow chipboard reinforced with rails and stiles (at extra charge). The reinforced model has two additional stabilizing rods. The '220' height includes three hinges and for natural veneer finishes, hollow chipboard core. The construction is skinned with HDF. Preparation for shortening hollow chipboard core, maximum 60 mm.

This door belongs  
to design line



## Hide

Check on  
the website



the visible gap is only 4 mm

## Tip

### PORTA HIDE DOOR LEAF WITH REINFORCEMENT

allows applications weighing up to 30 kg, the total weight of the leaf should not exceed 60 kg.

Learn more [➔ 87](#)

## Maximum weight of additional decorative elements on the door leaf

**NOTE:** The maximum permissible weight of the door leaf with additional decorative finish is **40 kg**.

### for the door leaf with hollow chipboard core

door leaf size	weight (kg)
60	20
70	15
80	10
90	5
100	0

### for the door leaf with honeycomb core

door leaf size	weight (kg)
60	27
70	25
80	24
90	22
100	21

## Can skirting boards be attached to PORTA HIDE doors?

A simple solution is to use a standard skirting board mounted on the door. However, remember to cut it at a 55° angle from the hinge side (non-rebated doors) so that the door leaf opens freely. The downside is visible gaps. In our offer you will find skirting boards for self-painting and in the most popular PORTA finishes.

Another solution are concealed skirting boards that are flush with the wall surface. The disadvantage is the need to install dedicated profiles at the stage of wall processing. If this solution is chosen, it should be verified with the mouldings producer.

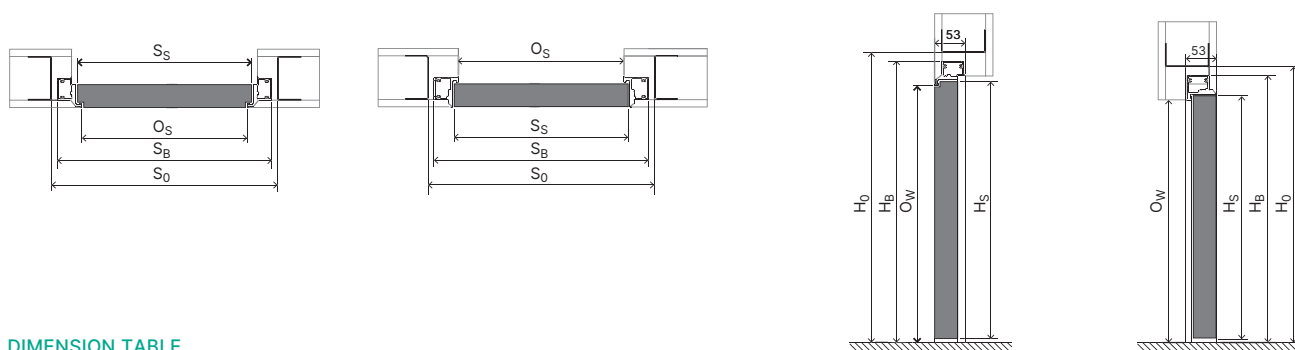

### DIMENSION TABLE

DOOR FRAME TYPE	Size	S <sub>s</sub>	H <sub>s</sub>	S <sub>0</sub>	H <sub>0</sub>	O <sub>s</sub>	O <sub>w</sub>	S <sub>B</sub>	H <sub>B</sub>	T <sub>s/w</sub>
PORTA HIDE non-rebated (outward opening)	60	618	2017	697	2070	603	2017	687	2059	+10 / -5
	70	718		797		703		787		
	80	818		897		803		887		
	90	918		997		903		987		
PORTA HIDE with reverse rebate (inward opening)	60	618	2027	697	2080	603	2027	687	2069	+10 / -5
	70	718		797		703		787		
	80	818		897		803		887		
	90	918		997		903		987		

**NOTE:** For doors with a height of '220', increase the dimensions: H<sub>s</sub>, H<sub>0</sub>, O<sub>w</sub>, H<sub>B</sub> by 200 mm.

# Modify to your style

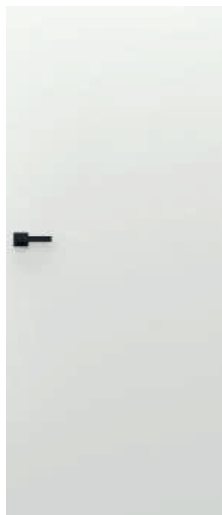

1.1  
Primer paint



Paint it your favorite colour



Cover with interesting  
wallpaper

## PORTA HIDE

Scan QR code  
and find out more  
about PORTA HIDE



Decorate with mouldings

Mouldings/slats can be found at [p 254](#)



Order in your chosen PORTA  
veneer - synthetic or natural

Door frame colours



Aluminum, primer included



White



Black

Finishes

See larger visualisations [➔](#) 252

FOR DIY PAINTING:

Primer



Paint

Premium UV Paint



White

Premium Plus UV Paint



White



Grey



Cashmere



Sage

**PLEASE NOTE!** The number in brackets, e.g. (1) is the finish group  
Check the back cover flap

(2) Uni Colours



White



Cashmere



Grey



Fjord



Olive

(2) Modern



Salvador Bleached Oak



Salvador Light Oak



Natural Arles Oak



Toffe Arles Oak



Dark Arles Oak

(2) Traditional



Matte Oak



Dark Matte Oak

Natural Veneer



Matte Oak



Oak 1



Oak Bianco



Oak



Walnut Taupe



Dark Walnut

Natural Veneer Select Matte



Oak



Walnut Taupe

Additionally

hollow chipboard core

ventilation undercut or recuperative shortcut

acoustic threshold 'drop' seal

SPECIAL OFFER - acoustic package

Natural matte veneer: Oak, Bianco Oak, Taupe Walnut

# PORTA HIDE WALL PANELING

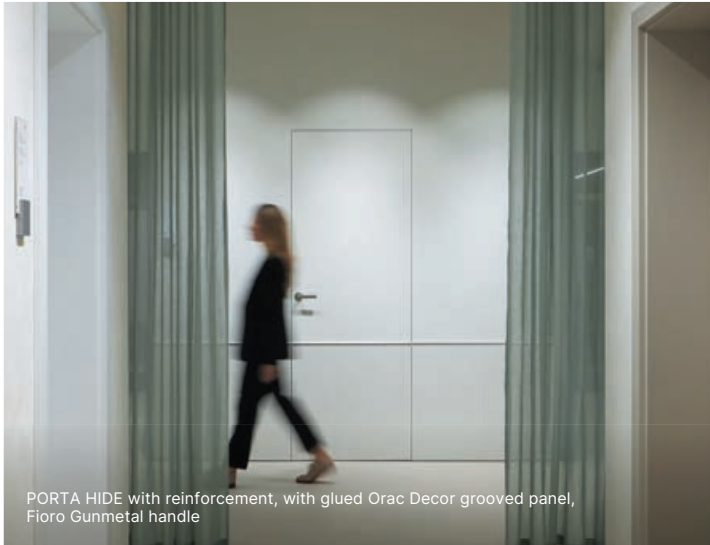

PORTA HIDE with reinforcement, with glued Orac Decor grooved panel, Fiore Gunmetal handle



PORTA HIDE with reinforcement, wall paneling finished with Casella Oak Simplo black handle



PORTA HIDE with reinforcement, with glued Orac Decor grooved panel, Fiore Gunmetal handle

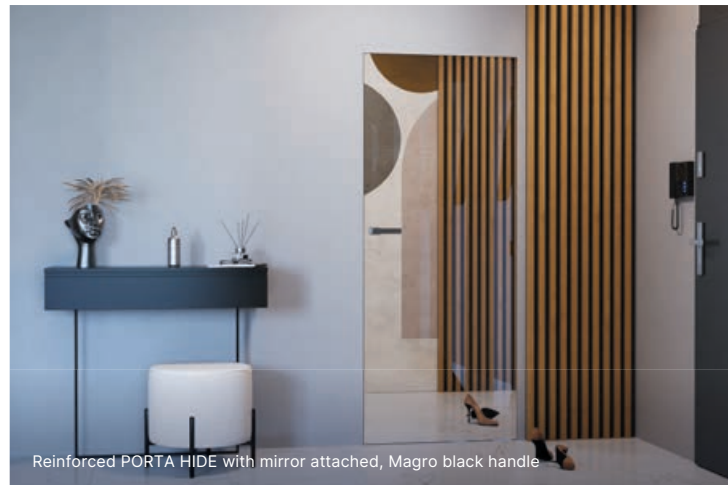

Reinforced PORTA HIDE with mirror attached, Magro black handle



A reinforced door leaf contains 2 straightening rods - so that it maintains its proper plane and does not bend (e.g. after gluing decorative elements). Rods can be adjusted from the top and bottom.

#### Reinforcement

- Allows for the application of dry and wet decorations on one side of the door.
- Allows applications weighing up to 30 kg to be mounted on the door leaf; the total weight of the door leaf should not exceed 60 kg.
- Comes with high door option - '220'.

## Door leaf with reinforcement, option with reverse rebate

The reinforced door leaf with a reverse rebate option allows mirrors, glass panes, laminated boards, or decorative panels with a thickness of up to 18 mm and a weight of up to 30 kg to be attached to the narrower side of the door leaf.



## PORTA HIDE

Scan QR code  
and find out more  
about PORTA HIDE



Delicate details that add character



# Motive

Solid door decorated with a discreet, milled ornament.  
A delicate detail adorns, but does not dominate. It is the perfect choice for those looking for a subtle variation, rather than a pattern that dictates style.



PORTA ART DECO

Check [➤ 90](#)



PORTA ART DECO

Check [➤ 90](#)



WATER

Check [➤ 92](#)



NATURE VERDINO

Check [➤ 94](#)

## Additional options



Higher

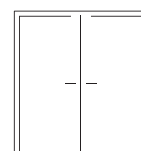

Double leaf

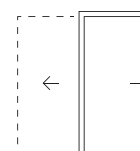

Sliding [➤ 170](#)

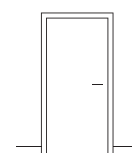

Skirting boards  
in many colours [➤ 231](#)



You can find more modification options on the pages with certain collection.

## Matching the Motive line

See all door handles and knobs [➤ 190](#)

### Handles



Moderno



Fioro



Azura



Supro

Check out the design lines on the website.



NEW

HYDRO PROTECT™

ACOUSTIC PACKAGE



220



60 - 100



120 - 200



Sliding door leaf



PORTA KLIMA II\*

\* possibility of changing the class from PORTA KLIMA I to PORTA KLIMA II, see page 4

### Recommended door frames

Door frames finished with Premium Lacquered veneer and with Premium Plus UV Paint:

Rebated door frames:

- PORTA SYSTEM **HYDRO PROTECT™**
- PORTA SYSTEM
- PORTA SYSTEM 90°

Non-rebated door frames:

- PORTA SYSTEM ELEGANCE **HYDRO PROTECT™**
- PORTA SYSTEM ELEGANCE
- PORTA SYSTEM ELEGANCE 90°
- LEVEL

Door frames with reverse rebate:

- PORTA SYSTEM with reverse rebate



Rebated



Non-rebated



with reverse rebate

### Notes

- PN EN 14351-2 standard.
- Double doors are available in any door leaf size combinations.
- Magnetic lock is not available for a double door.
- In double non-rebated doors, there are two, active and passive, leaves in sizes from '60' to '100'.
- Models 2 and 5 are not available in a sliding version.

# PORTA ART DECO



PORTA ART DECO 6, Sage, Fiore Gunmetal handle

### Construction

Honeycomb or hollow chipboard core reinforced with rails and stiles (at extra charge). The construction is skinned with HDF. Height '220' comes with hollow chipboard core and 3 hinges as standard. Size '100' requires third hinge.

This door belongs to design line



### Motive



FIORO handle



decorative milling close-up model 1, 5, 6, 7



decorative milling close-up model 2, 3



### Accessories

Learn more [↗](#) 190

Check on the website





Finishes

See larger visualisations [➔](#) 252

Premium UV Paint



White

Premium Plus UV Paint



White

Cashmere

Grey

Sage

Additionally

size '100'

door leaf height '220'

NEW garage set: see page 240

ventilation undercut or recuperative shortcut

hollow chipboard core

chipboard core

acoustic threshold 'drop' seal

SPECIAL OFFER - acoustic package

rebated: PRIME hinges (extra charge to the door frame price)

rebated: key lock and barrel hinges, black or gold colour

rebated: magnetic lock and barrel hinges, black or gold colour

rebated and non-rebated: magnetic lock with stainless steel faceplate

non-rebated: black, white, or gold magnetic lock

non-rebated: third 3D hinge (additional charge to the door frame price)

non-rebated: 3D hinges, gold colour (extra charge to the door frame price)

reverse rebate - extra charge added to door leaf price

reverse rebate - third 3D hinge (extra charge to door frame price)

reverse rebate - 3D hinges, gold colour (extra charge to door frame price)

sliding doors - oblong pull handle

sliding doors - hook lock with side pull handles

# WATER



220



60 - 100



PORTA KLIMA II\*

\* possibility of changing the class from PORTA KLIMA I to PORTA KLIMA II, see page 4

## Recommended door frames

### Non-rebated door frames:

- PORTA SYSTEM ELEGANCE 90°
- LEVEL

### Door frames with reverse rebate:

- PORTA SYSTEM with reverse rebate



Non-rebated



with reverse rebate

## Notes

- PN EN 14351-2 standard.



WATER W.2 collection, Magro handle, LEVEL door frame with milled panel

## Construction

Hollow chipboard core reinforced with rails and stiles. The construction is skinned with HDF. Preparation for shortening (maximum 60 mm).

This door belongs to design line



## Motive



## Accessories

Learn more [↗](#) 190

Check on the website



milling



decorative milling close-up

## Tip



### DESIGNED AS A SET

with PORTA SYSTEM ELEGANCE 90° or LEVEL door frame with a dedicated milled panel and Magro handle



W.1



W.2

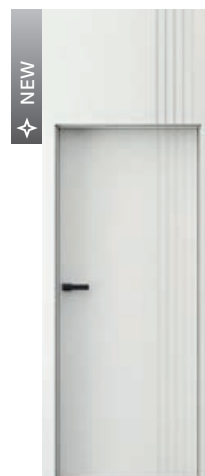

W.1 with LEVEL door frame and dedicated panel

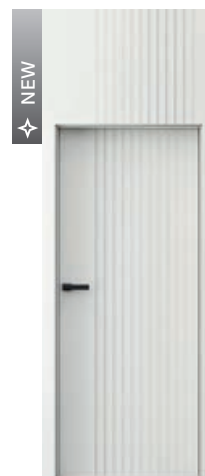

W.2 with LEVEL door frame and a dedicated panel

## Finishes

See larger visualisations → 252

### Premium Plus UV Paint



White

Cashmere

## Additionally

size '100'

door leaf height '220'

NEW garage set: see page 240

ventilation undercut or recuperative shortcut

acoustic threshold 'drop' seal

non-rebated: replacement of silver magnetic lock with a different colour

non-rebated: third 3D hinge in silver, black or white (extra charge to the door frame price)

reverse rebate - extra charge added to door leaf price

reverse rebate - third 3D hinge, silver, black, or white (extra charge to door frame price)

# NATURE VERDINO

## with embossing



60 - 100

Sliding  
door leafPORTA  
KLIMA I

### Recommended door frames

#### Rebated door frames:

- PORTA SYSTEM
- PORTA SYSTEM 90°

#### Non-rebated door frames:

- PORTA SYSTEM ELEGANCE
- PORTA SYSTEM ELEGANCE 90°

#### Door frames with reverse rebate:

- PORTA SYSTEM with reverse rebate



Rebated



Non-rebated

with rever-  
se rebate

### Notes

- PN EN 14351-2 standard.



NATURE VERDINO W.1, Matte Oak, Lago black handle

### Construction

Honeycomb or hollow chipboard core reinforced with rails and stiles.  
Hollow chipboard core at extra charge. Preparation for shortening  
maximum 60 mm.

This door belongs  
to design line



### Motive

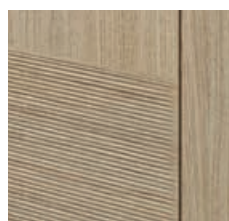

embossing



### Accessories

Learn more [↗](#) 190

Check on  
the website





W.1

### Details

The construction is skinned with a slim particle board which is finished with high quality natural veneer. The surface of the leaf is protected with environmentally friendly UV hardened water-based varnishes (matte).

### Finishes

See larger visualisations [➔](#) 252

#### Natural Veneer



Matte Oak

#### Natural Veneer Select Matte

Oak  
BiancoWalnut  
Taupe

### Additionally

size '100'

hollow chipboard core

NEW garage set: see page 240

ventilation undercut or recuperative shortcut

acoustic threshold 'drop' seal

SPECIAL OFFER - acoustic package

rebated: key lock and barrel hinges, black or gold colour

rebated: magnetic lock and barrel hinges, black or gold colour

rebated and non-rebated: magnetic lock with stainless steel faceplate

non-rebated: black, white, or gold magnetic lock

non-rebated: third 3D hinge (additional charge to the door frame price)

non-rebated: 3D hinges, gold colour (extra charge to the door frame price)

reverse rebate - extra charge added to door leaf price

reverse rebate - third 3D hinge (extra charge to door frame price)

reverse rebate - 3D hinges, gold colour (extra charge to door frame price)

sliding doors - oblong pull handle

sliding doors - hook lock with side pull handles

# Geometric harmony and rhythmic divisions



# Geometric

Doors decorated with attractive decorative inlays. This design line represents architectural order and pure form. It is distinguished by geometric lines – one, two or three, always arranged parallel to the edge of the door leaf and perpendicular to each other.

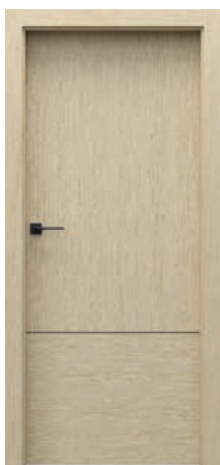

NATURE VERDINO

Check [➤ 98](#)



PORTA LINE

Check [➤ 100](#)

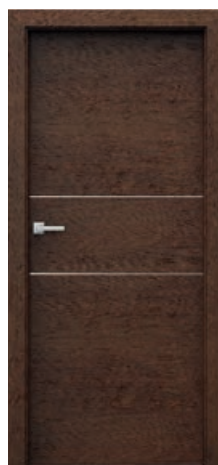

NATURE LINE

Check [➤ 100](#)



PORTA LEVEL LINE

Check [➤ 102](#)



PORTA DESIRE

Check [➤ 104](#)

## Additional options

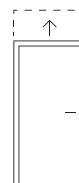

Higher

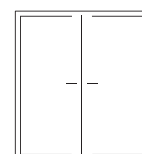

Double leaf

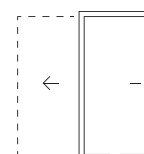

Sliding [➤ 170](#)

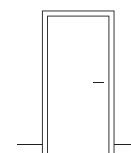

Skirting boards  
in many colours [➤ 231](#)



You can find more modification options on the pages with certain collection.

## Matched to the Geometric line

See all door handles and knobs [➤ 190](#)

### Handles



Margo Slim



Lago



Finaro Slim



Calio

Check out the design lines on the website.



# NATURE VERDINO

## with decorative inlays



220



60 - 100

Sliding  
door leaf

PORTA  
KLIMA I

### Recommended door frames

#### Rebated door frames:

- PORTA SYSTEM
- PORTA SYSTEM 90°

#### Non-rebated door frames:

- PORTA SYSTEM ELEGANCE
- PORTA SYSTEM ELEGANCE 90°

#### Door frames with reverse rebate:

- PORTA SYSTEM with reverse rebate



Rebated



Non-rebated

with rever-  
se rebate

### Notes

- PN EN 14351-2 standard.



NATURE VERDINO V.1 with decorative inlay, Bianco Oak Matte, height '220', Lago black handle

### Construction

Honeycomb or hollow chipboard core reinforced with rails and stiles. Hollow chipboard core at extra charge. Preparation for shortening maximum 60 mm. Height '220' comes with hollow chipboard core and 3 hinges as standard.

This door belongs  
to design line



Geometric



LAGO handle



### Accessories

Learn more [↗](#) 190

Check on  
the website



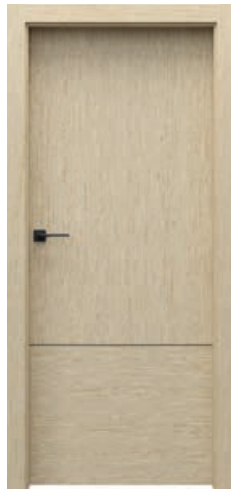

V.1 with decorative inlay



V.2 with decorative inlay



V.3 with decorative inlay

## Details

The construction is skinned with a slim particle board which is finished with high quality natural veneer. The surface of the leaf is protected with environmentally friendly UV hardened water-based varnishes (matte).

## Finishes

See larger visualisations [➔](#) 252

### Natural Veneer



Matte Oak

### Natural Veneer Select Matte

Oak  
BiancoTaupe  
Walnut

## Additionally

size '100'

door leaf height '220'

hollow chipboard core

NEW garage set: see page 240

ventilation undercut or recuperative shortcut

acoustic threshold 'drop' seal

SPECIAL OFFER - acoustic package

rebated: key lock and barrel hinges, black or gold colour

rebated: magnetic lock and barrel hinges, black or gold colour

rebated and non-rebated: magnetic lock with stainless steel faceplate

non-rebated: black, white, or gold magnetic lock

non-rebated: third 3D hinge (additional charge to the door frame price)

non-rebated: 3D hinges, gold colour (extra charge to the door frame price)

reverse rebate - extra charge added to door leaf price

reverse rebate - third 3D hinge (extra charge to door frame price)

reverse rebate - 3D hinges, gold colour (extra charge to door frame price)

sliding doors - oblong pull handle

sliding doors - hook lock with side pull handles

AQUA STOP  
(PORTA LINE)220 (NATURE  
LINE)

60 - 100



120 - 200

Sliding  
door leafTechnoPORTA  
Technology  
(PORTA LINE)PORTA  
KLIMA II\*

\* possibility of  
changing the class  
from PORTA KLIMA I  
to PORTA KLIMA II,  
see page 4

### Recommended door frames

#### Rebated door frames:

- PORTA SYSTEM **HYDRO PROTECT™**  
(PORTA LINE)
- PORTA SYSTEM
- PORTA SYSTEM 90°

#### Non-rebated door frames:

- PORTA SYSTEM ELEGANCE  
**HYDRO PROTECT™** (PORTA LINE)
- PORTA SYSTEM ELEGANCE
- PORTA SYSTEM ELEGANCE 90°

#### Door frames with reverse rebate:

- PORTA SYSTEM with reverse rebate



Rebated



Non-rebated

with reverse  
rebate

### Notes

- PN EN 14351-2 standard.
- Models C, F, and G are not available in double-leaf options.
- Double doors are available in any door leaf size combinations.
- Magnetic lock is not available for a double door.
- Passive leaf sizes: from '60' to '100'.  
PORTA LINE: Passive door leaf (side panel) in sizes '30', '40', '50' available only in solid option (without decorative applications).
- In double non-rebated doors, there are two, active and passive, leaves in sizes from '60' to '100'.
- NATURE LINE: recuperation shortcut available.
- PORTA LINE: Lower edge is protected against humidity in TechnoPORTA technology.



### Accessories

Learn more [↗](#) 190

# PORTA LINE, NATURE LINE



PORTA LINE L1, Cashmere, Lago black handle

### Construction

Honeycomb or hollow chipboard core reinforced with rails and stiles (at an extra charge). The construction is skinned with HDF. Chipboard core have preparation for shortening as a standard. Size '100' requires third hinge. NATURE LINE: height '220' includes hollow chipboard core and three hinges.

This door belongs  
to design line



### Geometric

Check on  
the website



Lago handle, black decorative inlays. Silver and golden inlays are also available.



**Details**

Door leaves are complemented with decorative inlays in silver, golden or black colour, width 6 mm. There is lipping ABS on the side edges of the doors finished with CPL. Sliding option of models F.1 and G.1 - decorative inlays placed on pull handle height.

**Finishes**

See larger visualisations → 252

**PORTA LINE:**

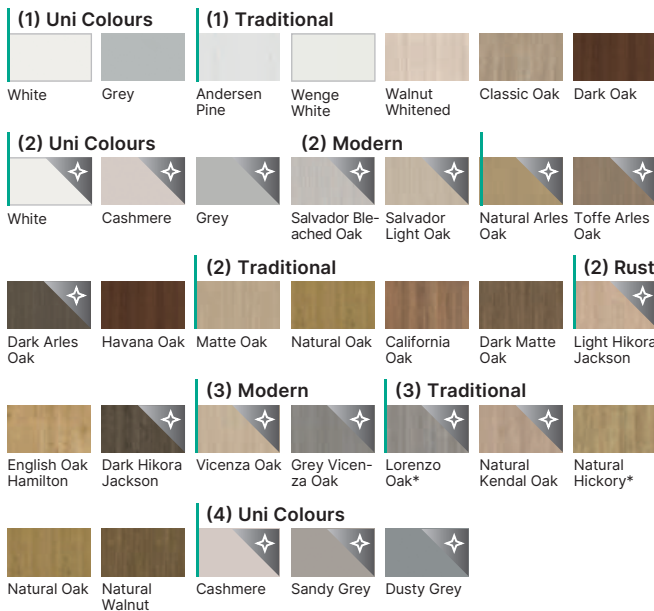

**NATURE LINE:**

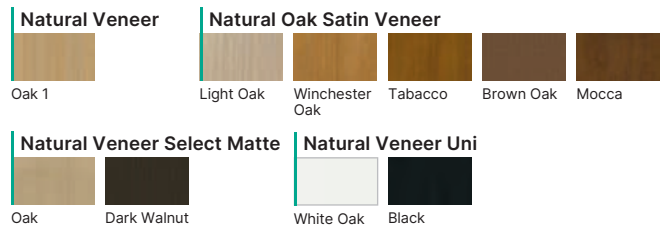

**PLEASE NOTE!** The number in brackets, e.g. (1) is the finish group. Check the back cover flap

**Additionally**

- size '100'
- door leaf height '220'
- hollow chipboard core
- chipboard core
- NEW garage set: see page 240
- ventilation undercut or recuperative shortcut
- acoustic threshold 'drop' seal
- SPECIAL OFFER - acoustic package
- CPL 0,2 - marked colours\*
- CPL 0,2 - UNI MATTE GROUP
- Natural veneer, White Oak, Satin
- Natural veneer, Select: Black

- rebrated: key lock and barrel hinges, black or gold colour
- rebrated: PRIME hinges (extra charge to the door frame price)
- rebrated: magnetic lock and barrel hinges, black or gold colour
- rebrated and non-rebrated: magnetic lock with stainless steel faceplate
- non-rebrated: black, white, or gold magnetic lock
- non-rebrated: third 3D hinge (additional charge to the door frame price)
- non-rebrated: 3D hinges, gold colour (extral charge to the door frame price)
- reverse rebate - extra charge added to door leaf price
- reverse rebate - third 3D hinge (extra charge to door frame price)
- reverse rebate - 3D hinges, gold colour (extra charge to door frame price)
- sliding doors - oblong pull handle
- sliding doors - hook lock with side pull handles

NEW

HYDRO PROTECT™

ACOUSTIC PACKAGE



60 - 100



120 - 200



Sliding door leaf



PORTA KLIMA II\*

\* possibility of changing the class from PORTA KLIMA I to PORTA KLIMA II, see page 4

### Recommended door frames

#### Rebated door frames:

- PORTA SYSTEM **HYDRO PROTECT™**
- PORTA SYSTEM
- PORTA SYSTEM 90°

#### Non-rebated door frames:

- PORTA SYSTEM ELEGANCE **HYDRO PROTECT™**
- PORTA SYSTEM ELEGANCE
- PORTA SYSTEM ELEGANCE 90°
- LEVEL

#### Door frames with reverse rebate:

- PORTA SYSTEM with reverse rebate



Rebated



Non-rebated



with reverse rebate

### Notes

- PN EN 14351-2 standard.
- Double doors are available in any door leaf size combinations.
- Magnetic lock is not available for a double door.
- Passive leaf sizes: from '60' to '100'. Passive door leaves (side panels) in sizes '30', '40', '50' available only in solid option (without decorative applications).
- In double non-rebated doors, there are two, active and passive, leaves in sizes from '60' to '100'.

# PORTA LEVEL LINE



PORTA LEVEL LINE L.3, Toffee Alres Oak, with LEVEL door frame, Lago black handle

### Construction

Honeycomb or hollow chipboard core reinforced with rails and stiles (at extra charge). The construction is skinned with HDF. Height '220' comes with hollow chipboard core and 3 hinges as standard. Size '100' requires third hinge.

This door belongs to design line



Geometric



### Accessories

Learn more [↗](#) 190

Check on the website



## PLEASE NOTE

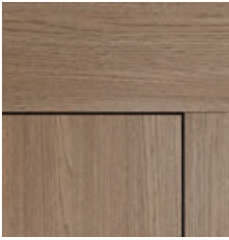

UNUSUAL POSSIBILITIES  
OF INTERIOR DESIGN  
WITH LEVEL DOOR FRAME

LEVEL door frame panel  
is available in heights of  
20 cm or 100 cm, may have  
vertical or horizontal grain  
direction



L.1



L.2



L.3

## Details

Door leaves are complemented with decorative inlays in silver, golden or black colour, width 6 mm.

## Finishes

See larger visualisations → 252

## (2) Modern



Salvador Bleached Oak Salvador Light Oak Natural Arles Oak Toffe Arles Oak Dark Arles Oak

## (2) Traditional

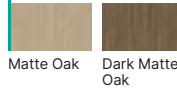

Matte Oak Dark Matte Oak

**PLEASE NOTE!** The number in brackets, e.g. (1) is the finish group  
Check the back cover flap

## Additionally

size '100'

hollow chipboard core

chipboard core

NEW garage set: see page 240

ventilation undercut

acoustic threshold 'drop' seal

SPECIAL OFFER - acoustic package

rebated: key lock and barrel hinges, black or gold colour

rebated: PRIME hinges (extra charge to the door frame price)

rebated: magnetic lock and barrel hinges, black or gold colour

rebated and non-rebated: magnetic lock with stainless steel faceplate

non-rebated: black, white, or gold magnetic lock

non-rebated: third 3D hinge (additional charge to the door frame price)

non-rebated: 3D hinges, gold colour (extra charge to the door frame price)

reverse rebate - extra charge added to door leaf price

reverse rebate - third 3D hinge (extra charge to door frame price)

reverse rebate - 3D hinges, gold colour (extra charge to door frame price)

sliding doors - oblong pull handle

sliding doors - hook lock with side pull handles

# PORTA DESIRE

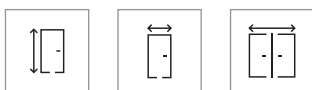

220

60 - 100

120 - 200

Sliding  
door leafPORTA  
KLIMA I

## Recommended door frames

### Rebated door frames:

- PORTA SYSTEM **HYDRO PROTECT™**
- PORTA SYSTEM
- PORTA SYSTEM 90°
- MINIMAX

### Non-rebated door frames:

- PORTA SYSTEM ELEGANCE **HYDRO PROTECT™**
- PORTA SYSTEM ELEGANCE
- PORTA SYSTEM ELEGANCE 90°
- LEVEL

### Door frames with reverse rebate:

- PORTA SYSTEM with reverse rebate



Rebated



Non-rebated

with rever-  
se rebate

## Notes

- PN EN 14351-2 standard.
- Double doors are available in any door leaf size combinations.
- Magnetic lock is not available for a double door.
- In double non-rebated doors, there are two, active and passive, leaves in sizes from '60' to '100'.
- Sliding doors not available with bathroom hook lock.



PORTA DESIRE 6, White, FIORO golden matte handle

## Construction

Hollow chipboard core reinforced with rails and stiles. The construction is skinned with HDF. Height '220' includes three hinges. Size '100' requires third hinge. Preparation for shortening (maximum 60 mm).

This door belongs  
to design line



## Geometric



black decorative inlay, silver  
and golden inlays are also  
available.



## Accessories

Learn more [↗](#) 190

Check on  
the website





Details

Colours of decorative inlays: silver, gold, black.

Finishes

See larger visualisations [➔ 252](#)

Premium Plus UV Paint



Additionally

size '100'	rebated and non-rebated: magnetic lock with stainless steel faceplate
door leaf height '220'	non-rebated: black, white, or gold magnetic lock
changing hollow chipboard into chipboard (height '220)	non-rebated: third 3D hinge (additional charge to the door frame price)
NEW garage set: see page 240	non-rebated: 3D hinges, gold colour (extral charge to the door frame price)
ventilation undercut or recuperative shortcut	reverse rebate - extra charge added to door leaf price
acoustic threshold 'drop' seal	reverse rebate - third 3D hinge (extra charge to door frame price)
rebated: key lock and barrel hinges, black or gold colour	reverse rebate - 3D hinges, gold colour (extra charge to door frame price)
rebated: PRIME hinges (extra charge to the door frame price)	sliding doors - oblong pull handle
rebated: magnetic lock and barrel hinges, black or gold colour	sliding doors - hook lock with side pull handles

Distinctive design  
defined by  
horizontal lines



PORTA VERTE HOME G.4, White, Euphoria silver handle

# Horizontal

Distinctive design based on horizontal divisions. The characteristic pattern of this design line is created by horizontal stripes of various widths. The doors are available with or without glazing, most often in a frame and panel construction.



PORTA LINE

Check [↗ 108](#)

Similar:

PORTA RESIST [↗ 108](#)  
NATURE LINE [↗ 108](#)



PORTA VECTOR  
PREMIUM

Check [↗ 110](#)

Similar:

PORTA FACTOR [↗ 110](#)



PORTA GRANDE  
(B AND G)

Check [↗ 112](#)

Similar:

NATURE GRANDE (B) [↗ 112](#)



PORTA VERTE  
PREMIUM (E)

Check [↗ 114](#)

Similar:

PORTA VERTE HOME (G) [↗ 116](#)  
PORTA INSPIRE (C) [↗ 118](#)



PORTA CONCEPT  
(A)

Check [↗ 120](#)

Similar:

PORTA VERTE PREMIUM (D)  
[↗ 120](#)



PORTA VERTE  
HOME (B)

Check [↗ 122](#)



PORTA CONCEPT  
(C, H)

Check [↗ 124](#)

Similar:

PORTA VERTE HOME (D)  
[↗ 132](#)



PORTA VERTE  
HOME (N)

Check [↗ 128](#)

Similar:

PORTA BALANCE (D) [↗ 128](#)  
PORTA CONCEPT (K) [↗ 126](#)



PORTA VERTE  
HOME (H, J)

Check [↗ 130](#)



PORTA VERTE  
HOME (C)

Check [↗ 134](#)

Similar:

PORTA FIT (G) [↗ 134](#)



PORTA VERTE  
PREMIUM (A)

Check [↗ 126](#)

Similar:

PORTA VERTE HOME (L) [↗ 136](#)  
PORTA FIT (H) [↗ 136](#)

## Additional options

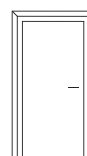

Decorative mouldings / slats

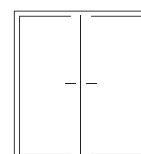

Double leaf

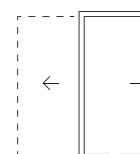

Sliding [↗ 170](#)

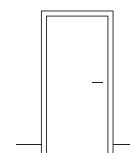

Skirting boards  
in many colours [↗ 231](#)



You can find more modification options  
on the pages with certain collection.

## Matched to the Horizontal line

See all door handles and knobs [↗ 190](#)

## Handles



Fiumo



Eleganto



Organic



Euphoria

Check out the  
design lines on  
the website.



AQUA  
STOP

60 - 100

Sliding  
door leafPORTA  
KLIMA II\*

\* possibility of  
changing the class  
from PORTA KLIMA I  
to PORTA KLIMA II,  
see page 4

### Recommended door frames

#### Rebated door frames:

- PORTA SYSTEM **HYDRO PROTECT™** (PORTA LINE, PORTA RESIST)
- PORTA SYSTEM
- PORTA SYSTEM 90°

#### Non-rebated door frames:

- PORTA SYSTEM ELEGANCE **HYDRO PROTECT™** (PORTA LINE, PORTA RESIST)
- PORTA SYSTEM ELEGANCE
- PORTA SYSTEM ELEGANCE 90°
- LEVEL (PORTA LINE, NATURE LINE)

#### Door frames with reverse rebate:

- PORTA SYSTEM with reverse rebate



Rebated



Non-rebated

with rever-  
se rebate

### Notes

- PN EN 14351-2 standard.
- PORTA LINE, PORTA RESIST: chipboard core available.
- NATURE LINE: recuperation shortcut available.
- PORTA LINE vertical graining, PORTA RESIST and NATURE LINE horizontal graining.
- Lower edge is protected against humidity in TechnoPORTA AQUA STOP technology (PORTA LINE, PORTA RESIST).

# PORTA LINE, PORTA RESIST, NATURE LINE



PORTA LINE E.1, Cashmere, Lago black handle

### Construction

Honeycomb or hollow chipboard core reinforced with rails and stiles (at extra charge). The construction is skinned with HDF. Chipboard core have preparation for shortening as standard. Size '100' requires third hinge. NATURE LINE: height '220' includes hollow chipboard core and three hinges.

This door belongs  
to design line



### Horizontal

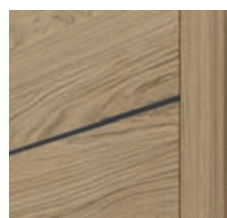

black decorative inlay, silver  
and golden inlays are also  
available



### Accessories

Learn more [↗](#) 190

Check on  
the website



## PORTA LINE, PORTA RESIST

Extra options for this collection:



TechnoPORTA Technology



E.1



E.1

## NATURE LINE

Extra options for this collection:



220

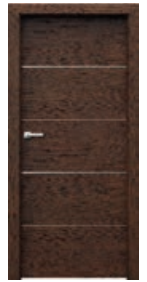

E.2

### Details

Door leaves are complemented with decorative inlays in silver, golden or black colour, width 6 mm. There is lipping ABS on the side edges of the doors finished with CPL or 3 mm Synchronous Board. PORTA RESIST: The door leaf is finished with a synchronous structure board, and the door frame is finished with a matching 0.2 mm CPL laminate. NATURE LINE: the construction is skinned with a slim particle board which is finished with high quality natural veneer. The door leaf surface is protected by ecological water-based varnishes.

### Finishes

See larger visualisations [➔](#) 252

#### PORTA LINE:

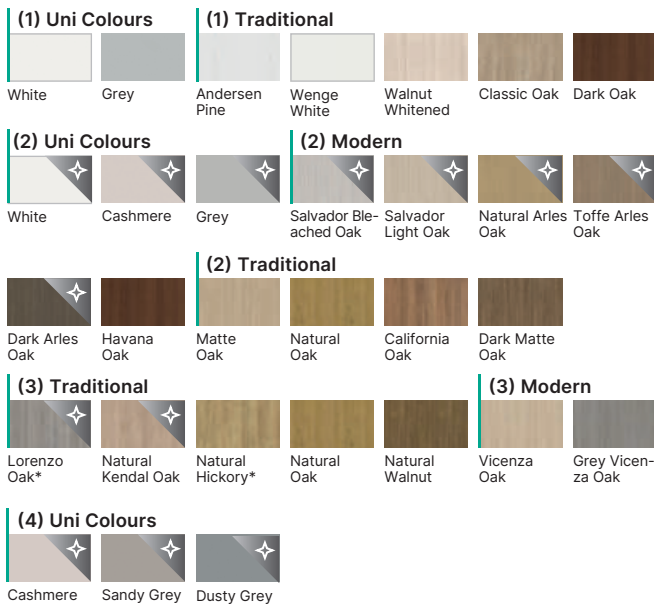

#### PORTA RESIST:

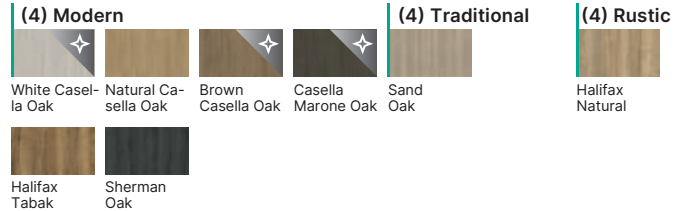

#### NATURE LINE:

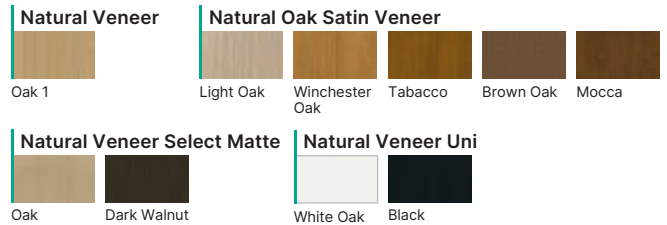

**PLEASE NOTE!** The number in brackets, e.g. (1) is the finish group  
Check the back cover flap

### Additionally

size '100'

hollow chipboard core

chipboard core

NEW garage set: see page 240

ventilation undercut or recuperative shortcut

acoustic threshold 'drop' seal

SPECIAL OFFER - acoustic package

rebated: key lock and barrel hinges, black or gold colour

rebated: PRIME hinges (extra charge to the door frame price)

rebated: magnetic lock and barrel hinges, black or gold colour

rebated and non-rebated: magnetic lock with stainless steel faceplate

non-rebated: black, white, or gold magnetic lock

non-rebated: third 3D hinge (additional charge to the door frame price)

non-rebated: 3D hinges, gold colour (extra charge to the door frame price)

reverse rebate - extra charge added to door leaf price

reverse rebate - third 3D hinge (extra charge to door frame price)

reverse rebate - 3D hinges, gold colour (extra charge to door frame price)

sliding doors - oblong pull handle

sliding doors - hook lock with side pull handles

CPL 0,2 - marked colours\*

CPL 0,2 - UNI MATTE GROUP

door leaf height '220'

Natural veneer, White Oak, Satin

Natural veneer, Select: Black

NEW

HYDRO PROTECT™

ACOUSTIC PACKAGE



220



60 - 100



120 - 200



Sliding door leaf



PORTA KLIMA II+

\* possibility of changing the class from PORTA KLIMA I to PORTA KLIMA II, see page 4

### Recommended door frames

Door frames finished with Premium Lacquered veneer, Premium Plus UV Paint:

Rebated door frames:

- PORTA SYSTEM **HYDRO PROTECT™**
- PORTA SYSTEM
- PORTA SYSTEM 90°
- MINIMAX

Non-rebated door frames:

- PORTA SYSTEM ELEGANCE **HYDRO PROTECT™**
- PORTA SYSTEM ELEGANCE
- PORTA SYSTEM ELEGANCE 90°
- LEVEL

Door frames with reverse rebate:

- PORTA SYSTEM with reverse rebate



Rebated



Non-rebated



with reverse rebate

### Notes

- PN EN 14351-2 standard.
- Double doors are available in any door leaf size combinations.
- Magnetic lock is not available for a double door.
- In double non-rebated doors, there are two, active and passive, leaves in sizes from '60' to '100'.

# PORTA VECTOR PREMIUM, PORTA FACTOR



PORTA VECTOR PREMIUM E, White, LEVEL door frame, Organic anthracite handle

### Construction

Honeycomb or hollow chipboard core reinforced with rails and stiles (at extra charge). The construction is skinned with HDF. Height '220' comes with hollow chipboard core and 3 hinges as standard. Size '100' requires third hinge.

This door belongs to design line



Horizontal



Eleganto handle



decorative milling close-up



Accessories

Learn more ↗ 190

Check on the website





Finishes

See larger visualisations [➤](#) 252

PORTA VECTOR PREMIUM:

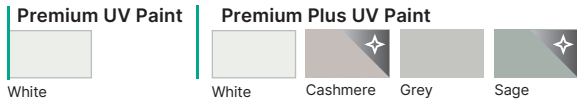

PORTA FACTOR:

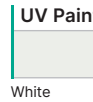

Additionally

- size '100'
- door leaf height '220'
- NEW garage set: see page 240
- ventilation undercut or recuperative shortcut
- hollow chipboard core
- chipboard core
- acoustic threshold 'drop' seal
- SPECIAL OFFER - acoustic package
- rebated: PRIME hinges (extra charge to the door frame price)
- rebated: key lock and barrel hinges, black or gold colour

- rebated: magnetic lock and barrel hinges, black or gold colour
- rebated and non-rebated: magnetic lock with stainless steel faceplate
- non-rebated: black, white, or gold magnetic lock
- non-rebated: third 3D hinge (additional charge to the door frame price)
- non-rebated: 3D hinges, gold colour (extra charge to the door frame price)
- reverse rebate - extra charge added to door leaf price
- reverse rebate - third 3D hinge (extra charge to door frame price)
- reverse rebate - 3D hinges, gold colour (extra charge to door frame price)
- sliding doors - oblong pull handle
- sliding doors - hook lock with side pull handles

# PORTA GRANDE g B and G, NATURE GRANDE g B

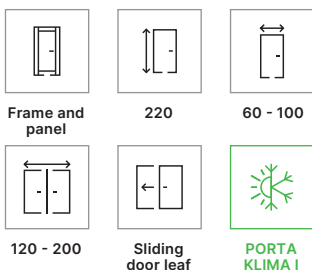

## Recommended door frames

### Rebated door frames:

- PORTA SYSTEM **HYDRO PROTECT™** (PORTA GRANDE)
- PORTA SYSTEM
- PORTA SYSTEM 90°

### Non-rebated door frames:

- PORTA SYSTEM ELEGANCE **HYDRO PROTECT™** (PORTA GRANDE)
- PORTA SYSTEM ELEGANCE
- PORTA SYSTEM ELEGANCE 90°

### Door frames with reverse rebate:

- PORTA SYSTEM with reverse rebate

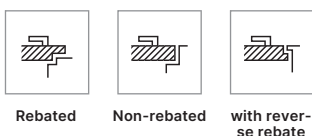

## Notes

- PN EN 14351-2 standard.
- Double doors are available in any door leaf size combinations.
- Magnetic lock is not available for a double door.
- In double non-rebated doors, there are two, active and passive, leaves in sizes from '60' to '100'.



## Construction

Frame and panel construction. The door leaves, depending on the design, consist of horizontal frames and 6 mm thick laminated safety frosted glass. Panels are 6 mm thick. Preparation for shortening maximum 60 mm. Size '100' requires third hinge. Height '220' - 3 hinges as standard.

This door belongs to design line



Horizontal



## Accessories

Learn more [↗](#) 190

Check on the website



PORTA GRANDE  
g B and D



NATURE GRANDE  
g B



Details

Option to replace the glass pane with 6 mm transparent tempered glass in models of group B. NATURE GRANDE: The entire surface has a finish of natural veneer. Surface is protected by ecological water-based varnishes. Select, Natural Oak and Satin veneers are hardened under UV lamp (semi-matte).

Finishes

See larger visualisations [➔](#) 252

PORTA GRANDE (B, G):

Premium Plus UV Paint



NATURE GRANDE (B):

Natural Veneer



Natural Oak Satin Veneer

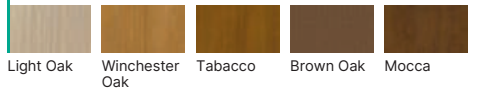

Natural Veneer Select Matte



Natural Veneer Uni



Additionally

- size '100'
- door leaf height '220'
- ventilation undercut
- acoustic threshold 'drop' seal
- black glass panel 1 piece - group G
- Natural veneer, White Oak, Satin
- Natural veneer, Select: Black
- rebated: key lock and barrel hinges, black or gold colour
- rebated: magnetic lock and barrel hinges, black or gold colour

- rebated and non-rebated: magnetic lock with stainless steel faceplate
- non-rebated: black, white, or gold magnetic lock
- non-rebated: third 3D hinge (additional charge to the door frame price)
- non-rebated: 3D hinges, gold colour (extra charge to the door frame price)
- reverse rebate - extra charge added to door leaf price
- reverse rebate - third 3D hinge (extra charge to door frame price)
- reverse rebate - 3D hinges, gold colour (extra charge to door frame price)
- sliding doors - oblong pull handle
- sliding doors - hook lock with side pull handles

# PORTA VERTE PREMIUM

## g E

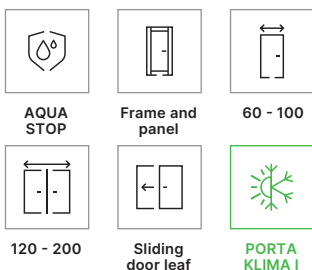

### Recommended door frames

#### Rebated door frames:

- PORTA SYSTEM **HYDRO PROTECT™**
- PORTA SYSTEM
- PORTA SYSTEM 90°
- MINIMAX

#### Non-rebated door frames:

- PORTA SYSTEM ELEGANCE **HYDRO PROTECT™**
- PORTA SYSTEM ELEGANCE
- PORTA SYSTEM ELEGANCE 90°
- LEVEL

#### Door frames with reverse rebate:

- PORTA SYSTEM with reverse rebate

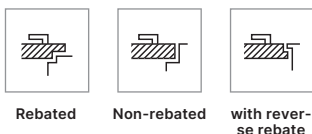

### Notes

- PN EN 14351-2 standard.
- Double doors are available in any door leaf size combinations.
- Magnetic lock is not available for a double door.
- In double non-rebated doors, there are two, active and passive, leaves in sizes from '60' to '100'.
- Black glazing is not available for sliding door leaves.
- The lower surface of stiles are protected against humidity thanks to TechnoPORTA AQUA STOP.



### Construction

Door leaves contain rails and stiles, slim panels and 6 mm thick, frosted, tempered glass. Combination of those depends on a model. Preparation for shortening maximum 60 mm. Size '100' requires third hinge.

This door belongs to design line



### Horizontal



### Accessories

Learn more [↗](#) 190

Check on the website



frosted glass panel



black glass panel



Finishes

See larger visualisations → 252

Premium Plus UV Paint



(2) Uni Colours



(2) Modern



(1) Uni Colours



(1) Traditional

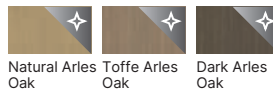
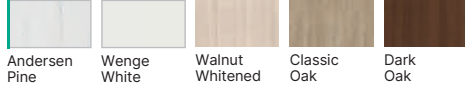

(2) Traditional

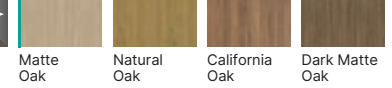

(1) Rustic



(2) Rustic



**PLEASE NOTE!** The number in brackets, e.g. (1) is the finish group  
Check the back cover flap

Additionally

- size '100'
- ventilation undercut
- black glass panel 1 pc.
- acoustic threshold 'drop' seal
- rebated: PRIME hinges (extra charge to the door frame price)
- rebated: key lock and barrel hinges, black or gold colour
- rebated: magnetic lock and barrel hinges, black or gold colour
- rebated and non-rebated: magnetic lock with stainless steel faceplate

- non-rebated: black, white, or gold magnetic lock
- non-rebated: third 3D hinge (additional charge to the door frame price)
- non-rebated: 3D hinges, gold colour (extra charge to the door frame price)
- reverse rebate - extra charge added to door leaf price
- reverse rebate - third 3D hinge (extra charge to door frame price)
- reverse rebate - 3D hinges, gold colour (extra charge to door frame price)
- sliding doors - oblong pull handle
- sliding doors - hook lock with side pull handles

# PORTA VERTE HOME g G

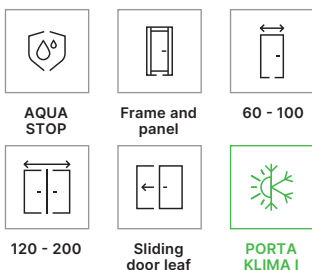

## Recommended door frames

### Rebated door frames:

- PORTA SYSTEM **HYDRO PROTECT™**
- PORTA SYSTEM
- PORTA SYSTEM 90°
- MINIMAX
- STEEL DOOR FRAMES

### Non-rebated door frames:

- PORTA SYSTEM ELEGANCE **HYDRO PROTECT™**
- PORTA SYSTEM ELEGANCE
- PORTA SYSTEM ELEGANCE 90°
- LEVEL

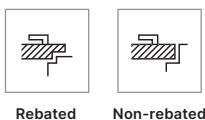

## Notes

- PN EN 14351-2 standard.
- Double doors are available in any door leaf size combinations.
- Magnetic lock is not available for a double door.
- In double non-rebated doors, there are two, active and passive, leaves in sizes from '60' to '100'.
- Black glazing is not available for sliding door leaves.
- The lower surface of stiles are protected against humidity thanks to TechnoPORTA AQUA STOP.



## Construction

Door leaves contain rails and stiles, slim panels and 4 mm thick, frosted, tempered glass. Combination of those depends on a model. Preparation for shortening (maximum 30 mm). Size '100' requires third hinge.

This door belongs to design line



## Horizontal



### Accessories

Learn more [↗](#) 190

Check on the website



Eleganto handle, frosted glass



Finishes

See larger visualisations → 252

<p><b>(1) Uni Colours</b></p> <p>White      Grey      Fjord      Olive</p>	<p><b>(1) Traditional</b></p> <p>Andersen Pine      Wenge White      Walnut Whitened</p>	<p><b>(2) Uni Colours</b></p> <p>White      Cashmere      Grey</p>
<p><b>(1) Rustic</b></p> <p>Norwegian Pine      Silver Acacia      Golden Craft Oak      Mauvella oak      Catania Oak      Honey Acacia      Scarlet Oak</p>	<p><b>(2) Modern</b></p> <p>Salvador Bleached Oak      Salvador Light Oak      Natural Arles Oak      Toffe Arles Oak      Dark Arles Oak</p>	<p><b>(2) Traditional</b></p> <p>Matte Oak      Natural Oak      Dark Matte Oak</p>
		<p><b>(2) Rustic</b></p> <p>Scandinavian Oak      Light Hikora Jackson      Siberian Oak      Dark Hikora Jackson</p>

**PLEASE NOTE!** The number in brackets, e.g. (1) is the finish group  
Check the back cover flap

Additionally

- size '100'
- ventilation undercut
- black glass panel 1 pc.
- acoustic threshold 'drop' seal
- rebated: PRIME hinges (extra charge to the door frame price)
- rebated: key lock and barrel hinges, black or gold colour
- rebated: magnetic lock and barrel hinges, black or gold colour

- rebated and non-rebated: magnetic lock with stainless steel faceplate
- non-rebated: black, white, or gold magnetic lock
- non-rebated: third 3D hinge (additional charge to the door frame price)
- non-rebated: 3D hinges, gold colour (extra charge to the door frame price)
- sliding doors - oblong pull handle
- sliding doors - hook lock with side pull handles

# PORTA INSPIRE g C

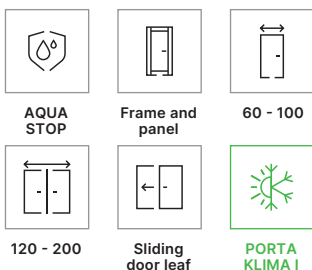

## Recommended door frames

### Rebated door frames:

- PORTA SYSTEM **HYDRO PROTECT™**
- PORTA SYSTEM
- PORTA SYSTEM 90°

### Non-rebated door frames:

- PORTA SYSTEM ELEGANCE **HYDRO PROTECT™**
- PORTA SYSTEM ELEGANCE
- PORTA SYSTEM ELEGANCE 90°
- LEVEL

### Door frames with reverse rebate:

- PORTA SYSTEM with reverse rebate

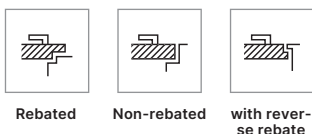

## Notes

- PN EN 14351-2 standard.
- Double doors are available in any door leaf size combinations.
- Magnetic lock is not available for a double door.
- In double non-rebated doors, there are two, active and passive, leaves in sizes from '60' to '100'.
- Black glazing is not available for sliding door leaves.
- The lower surface of stiles are protected against humidity thanks to TechnoPORTA AQUA STOP.



## Construction

Door leaves contain rails and stiles, slim panels and 6 mm thick, frosted, tempered glass. Combination of those depends on a model. Preparation for shortening maximum 60 mm. Size '100' requires third hinge.

This door belongs to design line



## Horizontal



## Accessories

Learn more [↗](#) 190

Check on the website



**PLEASE NOTE**



**SPECIAL CONSTRUCTION**

with glued wood elements  
(option at extra charge)



C.0



C.2



C.4



C.4 with black glass panes

**Finishes**

See larger visualisations ➔ 252

<p><b>(1) Uni Colours</b></p> <p>White   Grey   Andersen Pine   Wenge White</p>	<p><b>(1) Traditional</b></p> <p>Classic Oak   Dark Oak</p>
<p><b>(1) Rustic</b></p> <p>Norwegian Pine   Silver Acacia   Golden Craft Oak   Mauvella oak   Catania Oak   Honey Acacia   Scarlet Oak</p>	

<p><b>(2) Uni Colours</b></p> <p>White</p>	<p><b>(2) Traditional</b></p> <p>Matte Oak   Natural Oak   California Oak   Dark Matte Oak</p>
<p><b>(2) Rustic</b></p> <p>Scandinavian Oak   Light Hikora Jackson   English Oak Hamilton   Siberian Oak   Dark Hikora Jackson</p>	

**PLEASE NOTE!** The number in brackets, e.g. (1) is the finish group  
Check the back cover flap

**Additionally**

- size '100'
- multi-layered wooden construction (vertical stiles)
- black glass panel 1 pc.
- ventilation undercut
- acoustic threshold 'drop' seal
- rebated and non-rebated: magnetic lock with stainless steel faceplate
- non-rebated: black, white, or gold magnetic lock

- non-rebated: third 3D hinge (additional charge to the door frame price)
- non-rebated: 3D hinges, gold colour (extral charge to the door frame price)
- reverse rebate - extra charge added to door leaf price
- reverse rebate - third 3D hinge (extra charge to door frame price)
- reverse rebate - 3D hinges, gold colour (extra charge to door frame price)
- sliding doors - oblong pull handle
- sliding doors - hook lock with side pull handles

# PORTA CONCEPT g A, PORTA VERTE PREMIUM g D

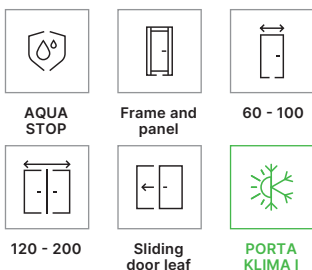

## Recommended door frames

### Rebated door frames:

- PORTA SYSTEM **HYDRO PROTECT™**
- PORTA SYSTEM
- PORTA SYSTEM 90°

### Non-rebated door frames:

- PORTA SYSTEM ELEGANCE **HYDRO PROTECT™**
- PORTA SYSTEM ELEGANCE
- PORTA SYSTEM ELEGANCE 90°
- LEVEL

### Door frames with reverse rebate:

- PORTA SYSTEM with reverse rebate

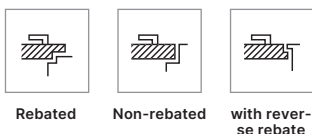

## Notes

- PN EN 14351-2 standard.
- Double doors are available in any door leaf size combinations.
- Magnetic lock is not available for a double door.
- In double non-rebated doors, there are two, active and passive, leaves in sizes from '60' to '100'.
- Black glazing is not available for sliding door leaves.
- The lower surface of stiles are protected against humidity thanks to TechnoPORTA AQUA STOP.



## Construction

Door leaves contain rails and stiles, slim panels and 6 mm thick, frosted, tempered glass. Combination of those depends on a model. Preparation for shortening maximum 60 mm. Size '100' requires third hinge.

This door belongs to design line



## Horizontal



Eleganto handle, frosted glass



## Accessories

Learn more [↗](#) 190

Check on the website



**PLEASE NOTE**



**SPECIAL CONSTRUCTION**

with elements of glued wood  
-PORTA CONCEPT (optionally at extra charge)

**PORTA CONCEPT  
g A**



A.0



A.3



A.9



A.9 with black glass pane

**PORTA VERTE  
PREMIUM g D**



D.0



D.2



D.3



D.8

**Finishes**

See larger visualisations [➤](#) 252

**(1) Uni Colours**



White



Grey

**(1) Traditional**



Andersen Pine



Wenge White



Walnut Whitened



Classic Oak



Dark Oak

**(1) Rustic**



Norwegian Pine



Golden Craft Oak



Catania Oak



Scarlet Oak

**(2) Uni Colours**



White



Cashmere



Grey

**(2) Modern**



Salvador Bleached Oak



Salvador Light Oak



Natural Arles Oak



Toffe Arles Oak

**(2) Traditional**



Dark Arles Oak



Havana Oak



Matte Oak



Natural Oak



California Oak



Dark Matte Oak

**(2) Rustic**



Scandinavian Oak



Light Hikora Jackson



English Oak Hamilton



Siberian Oak



Dark Hikora Jackson

**PLEASE NOTE!** The number in brackets, e.g. (1) is the finish group  
Check the back cover flap

**Additionally**

- size '100'
- multi-layered wooden construction (vertical stiles, PORTA CONCEPT)
- black glass panel 1 pc. - PORTA CONCEPT
- ventilation undercut
- acoustic threshold 'drop' seal
- rebated: PRIME hinges ( extra charge to the PORTA VERTE PREMIUM door frame price)
- rebated: key lock and barrel hinges, black or gold colour (PORTA VERTE PREMIUM)
- rebated: magnetic lock and barrel hinges, black or gold colour (PORTA VERTE PREMIUM)

- rebated and non-rebated: magnetic lock with stainless steel faceplate
- non-rebated: black, white, or gold magnetic lock
- non-rebated: third 3D hinge (additional charge to the door frame price)
- non-rebated: 3D hinges, gold colour (extral charge to the door frame price)
- reverse rebate - extra charge added to door leaf price
- reverse rebate - third 3D hinge (extra charge to door frame price)
- reverse rebate - 3D hinges, gold colour (extra charge to door frame price)
- sliding doors - oblong pull handle
- sliding doors - hook lock with side pull handles

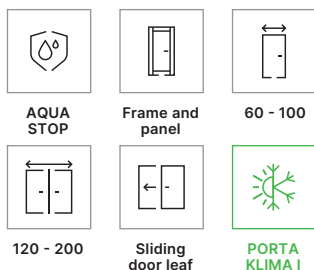

### Recommended door frames

#### Rebated door frames:

- PORTA SYSTEM **HYDRO PROTECT™**
- PORTA SYSTEM
- PORTA SYSTEM 90°
- MINIMAX
- STEEL DOOR FRAMES

#### Non-rebated door frames:

- PORTA SYSTEM ELEGANCE **HYDRO PROTECT™**
- PORTA SYSTEM ELEGANCE
- PORTA SYSTEM ELEGANCE 90°
- LEVEL

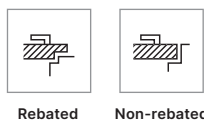

### Notes

- PN EN 14351-2 standard.
- Double doors are available in any door leaf size combinations.
- Magnetic lock is not available for a double door.
- In double non-rebated doors, there are two, active and passive, leaves in sizes from '60' to '100'.
- The width (thickness) of the painted lines on the glass for model B.5 is 25 mm, with a one-sided design.
- Transparent painted glass pane not available for sliding doors.
- Black colour available for B.5 model
- The lower surface of stiles are protected against humidity thanks to TechnoPORTA AQUA STOP.

# PORTA VERTE HOME g B



### Construction

Door leaves contain rails and stiles, slim panels and 4 mm thick, frosted, tempered glass panes with transparent stripes. Combination of those depends on a model. The B.5 model is available with a transparent glass pane and a glass pane with painted muntins. Preparation for shortening (maximum 30 mm). Width '100' requires 3rd hinge.

This door belongs to design line



### Horizontal



dedicated frosted glass with transparent stripes



### Accessories

Learn more [↗](#) 190

Check on the website





Finishes

See larger visualisations → 252

(1) Uni Colours



White Grey Fjord Olive

(2) Uni Colours



White Cashmere Grey Black

(1) Traditional



Andersen Pine Wenge White Walnut Whitened Classic Oak Dark Oak

(2) Modern



Salvador Bleached Oak Salvador Light Oak Natural Arles Oak Toffe Arles Oak Dark Arles Oak Havana Oak

(2) Traditional

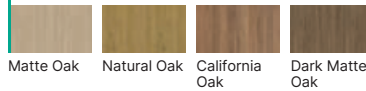

Matte Oak Natural Oak California Oak Dark Matte Oak

**PLEASE** The number in brackets, e.g. (1) is the finish group  
**NOTE!** Check the back cover flap

Additionally

size '100'

transparent painted glass

transparent glass

ventilation undercut

acoustic threshold 'drop' seal

rebated: PRIME hinges (extra charge to the door frame price)

rebated: key lock and barrel hinges, black or gold colour

rebated: magnetic lock and barrel hinges, black or gold colour

rebated and non-rebated: magnetic lock with stainless steel faceplate

non-rebated: black, white, or gold magnetic lock

non-rebated: third 3D hinge (additional charge to the door frame price)

non-rebated: 3D hinges, gold colour (extra charge to the door frame price)

sliding doors - oblong pull handle

sliding doors - hook lock with side pull handles

# PORTA CONCEPT g C and H

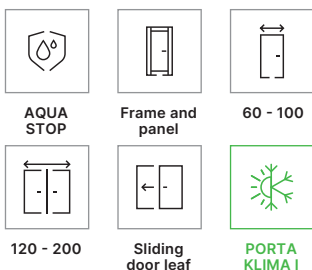

## Recommended door frames

### Rebated door frames:

- PORTA SYSTEM **HYDRO PROTECT™**
- PORTA SYSTEM
- PORTA SYSTEM 90°

### Non-rebated door frames:

- PORTA SYSTEM ELEGANCE **HYDRO PROTECT™**
- PORTA SYSTEM ELEGANCE
- PORTA SYSTEM ELEGANCE 90°
- LEVEL

### Door frames with reverse rebate:

- PORTA SYSTEM with reverse rebate

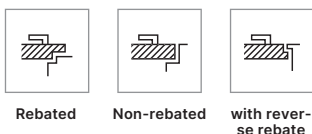

## Notes

- PN EN 14351-2 standard.
- Double doors are available in any door leaf size combinations.
- Magnetic lock is not available for a double door.
- In double non-rebated doors, there are two, active and passive, leaves in sizes from '60' to '100'.
- The lower surface of stiles are protected against humidity thanks to TechnoPORTA AQUA STOP.



## Construction

Door leaves contain rails and stiles, slim panels and 6 mm thick, frosted, tempered glass. Combination of those depends on a model. Preparation for shortening maximum 60 mm. Size '100' requires third hinge.

This door belongs to design line



## Horizontal



Eleganto handle



## Accessories

Learn more ↗ 190

Check on the website



**PLEASE NOTE**



**SPECIAL CONSTRUCTION**

with glued wood elements  
(option at extra charge)

group C



C.0



C.2



C.6

group H



H.0



H.2



H.4

**Finishes**

See larger visualisations [➔ 252](#)

**(1) Uni Colours**



White



Grey



Andersen Pine



Wenge White



Walnut Whitened



Classic Oak



Dark Oak

**(1) Traditional**

**(1) Rustic**



Norwegian Pine



Golden Craft Oak



Catania Oak



Scarlet Oak

**(2) Uni Colours**



White



Cashmere



Grey

**(2) Modern**



Salvador Bleached Oak



Salvador Light Oak



Natural Arles Oak



Toffe Arles Oak

**(2) Traditional**



Dark Arles Oak



Havana Oak



Matte Oak



Natural Oak



California Oak



Dark Matte Oak

**(2) Rustic**



Scandinavian Oak



Light Hikora Jackson



English Oak Hamilton



Siberian Oak



Dark Hikora Jackson

**PLEASE NOTE!** The number in brackets, e.g. (1) is the finish group  
Check the back flap of the cover.

**Additionally**

- size '100'
- multi-layered wooden construction (vertical stiles)
- ventilation undercut
- acoustic threshold 'drop' seal
- rebated and non-rebated: magnetic lock with stainless steel faceplate
- non-rebated: black, white, or gold magnetic lock
- non-rebated: third 3D hinge (additional charge to the door frame price)

- non-rebated: 3D hinges, gold colour (extral charge to the door frame price)
- reverse rebate - extra charge added to door leaf price
- reverse rebate - third 3D hinge (extra charge to door frame price)
- reverse rebate - 3D hinges, gold colour (extra charge to door frame price)
- sliding doors - oblong pull handle
- sliding doors - hook lock with side pull handles

# PORTA CONCEPT g K, PORTA VERTE PREMIUM g A

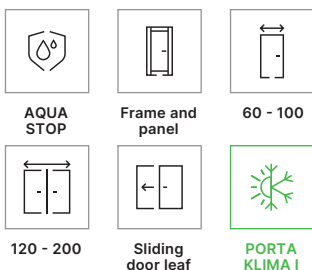

## Recommended door frames

### Rebated door frames:

- PORTA SYSTEM **HYDRO PROTECT™**
- PORTA SYSTEM
- PORTA SYSTEM 90°

### Non-rebated door frames:

- PORTA SYSTEM ELEGANCE **HYDRO PROTECT™**
- PORTA SYSTEM ELEGANCE
- PORTA SYSTEM ELEGANCE 90°
- LEVEL

### Door frames with reverse rebate:

- PORTA SYSTEM with reverse rebate

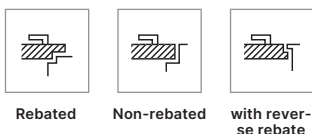

## Notes

- PN EN 14351-2 standard.
- Double doors are available in any door leaf size combinations.
- Magnetic lock is not available for a double door.
- In double non-rebated doors, there are two, active and passive, leaves in sizes from '60' to '100'.
- The lower surface of stiles are protected against humidity thanks to TechnoPORTA AQUA STOP.



## Construction

Door leaves contain rails and stiles, slim panels and 6 mm thick, frosted, tempered glass. Combination of those depends on a model. Preparation for shortening maximum 60 mm. Size '100' requires third hinge.

This door belongs to design line



## Horizontal



Eleganto handle



## Accessories

Learn more [↗](#) 190

Check on the website



**PLEASE NOTE**



**SPECIAL CONSTRUCTION**

with elements of glued wood  
- PORTA CONCEPT (optionally at extra charge)

**PORTA CONCEPT  
g K**



K.0



K.1



K.3

**PORTA VERTE  
PREMIUM g A**



A.0



A.1



A.4

**Finishes**

See larger visualisations → 252

**(1) Uni Colours**



White



Grey

**(1) Traditional**



Andersen Pine



Walnut Whitened

**(1) Rustic**



Norwegian Pine



Silver Acacia



Mauvella Oak



Golden Craft Oak



Catania Oak



Honey Acacia



Scarlet Oak

**(2) Uni Colours**



White



Cashmere



Grey

**(2) Traditional**



Matte Oak



Natural Oak



California Oak



Dark Matte Oak

**(2) Rustic**



Scandinavian Oak



Light Hikora Jackson



English Oak Hamilton



Siberian Oak



Dark Hikora Jackson

**PLEASE NOTE!** The number in brackets, e.g. (1) is the finish group  
Check the back flap of the cover.

**Additionally**

- size '100'

---

- multi-layered wooden construction (vertical stiles, PORTA CONCEPT)

---

- ventilation undercut

---

- acoustic threshold 'drop' seal

---

- rebated: PRIME hinges ( extra charge to the PORTA VERTE PREMIUM door frame price)

---

- rebated: key lock and barrel hinges, black or gold colour (PORTA VERTE PREMIUM)

---

- rebated: magnetic lock and barrel hinges, black or gold colour (PORTA VERTE PREMIUM)

- rebated and non-rebated: magnetic lock with stainless steel faceplate

---

- non-rebated: black, white, or gold magnetic lock

---

- non-rebated: third 3D hinge (additional charge to the door frame price)

---

- non-rebated: 3D hinges, gold colour (extra charge to the door frame price)

---

- reverse rebate - extra charge added to door leaf price

---

- reverse rebate - third 3D hinge (extra charge to door frame price)

---

- reverse rebate - 3D hinges, gold colour (extra charge to door frame price)

---

- sliding doors - oblong pull handle

---

- sliding doors - hook lock with side pull handles

# PORTA BALANCE g D, PORTA VERTE HOME g N

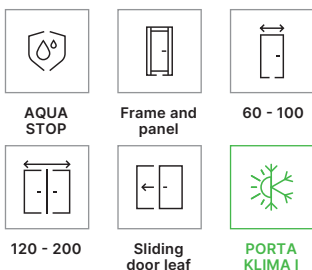

## Recommended door frames

### Rebated door frames:

- PORTA SYSTEM **HYDRO PROTECT™**
- PORTA SYSTEM
- PORTA SYSTEM 90°
- MINIMAX
- STEEL DOOR FRAMES

### Non-rebated door frames:

- PORTA SYSTEM ELEGANCE **HYDRO PROTECT™**
- PORTA SYSTEM ELEGANCE
- PORTA SYSTEM ELEGANCE 90°
- LEVEL

### Door frames with reverse rebate (PORTA BALANCE):

- PORTA SYSTEM with reverse rebate

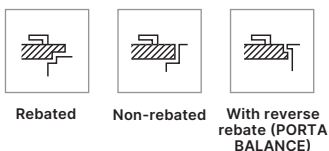

## Notes

- PN EN 14351-2 standard.
- Double doors are available in any door leaf size combinations.
- Magnetic lock is not available for a double door.
- In double non-rebated doors, there are two, active and passive, leaves in sizes from '60' to '100'.
- Black colour available for the PORTA VERTE HOME N.3 model.
- The lower surface of stiles are protected against humidity thanks to TechnoPORTA AQUA STOP.



PORTA VERTE HOME N.0 and N.3, Dark matte oak, DORO black handle

## Construction

Door leaves contain rails and stiles, slim panels and 4 mm thick, frosted, tempered glass. Combination of those depends on a model. Preparation for shortening (maximum 30 mm). Size '100' requires third hinge.

This door belongs  
to design line



## Horizontal



## Accessories

Learn more [↗](#) 190

Check on  
the website



PORTA BALANCE: profiled  
panel, model D.0

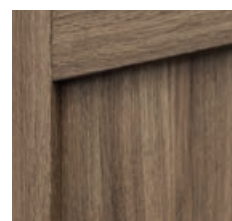

PORTA VERTE HOME: panel,  
model N.0



**Finishes**

See larger visualisations → 252

**Applies to both models:**

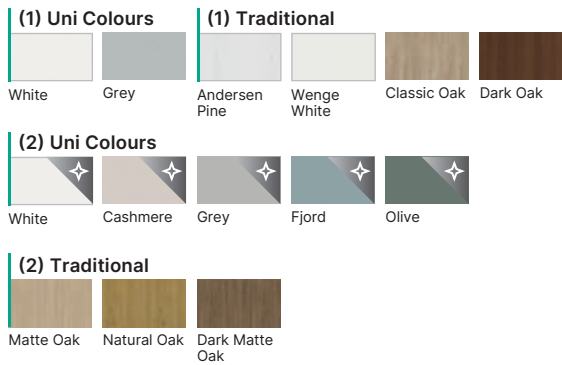

**Only for PORTA BALANCE (D):**



**Only for PORTA VERTE HOME (N):**

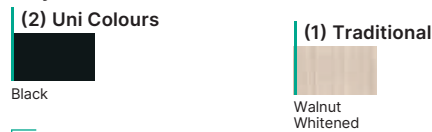

**PLEASE NOTE!** The number in brackets, e.g. (1) is the finish group. Check the back flap of the cover.

**Additionally**

- size '100'
- ventilation undercut
- transparent glass panel models from group N, 1 piece .
- acoustic threshold 'drop' seal
- rebated: PRIME hinges (extra charge to the door frame price)
- rebated: key lock and barrel hinges, black or gold colour
- rebated: magnetic lock and barrel hinges, black or gold colour
- rebated and non-rebated: magnetic lock with stainless steel faceplate

- non-rebated: black, white, or gold magnetic lock
- non-rebated: third 3D hinge (additional charge to the door frame price)
- non-rebated: 3D hinges, gold colour (extral charge to the door frame price)
- reverse rebate - extra charge added to door leaf price
- reverse rebate - third 3D hinge (extra charge to door frame price)
- reverse rebate - 3D hinges, gold colour (extra charge to door frame price)
- sliding doors - oblong pull handle
- sliding doors - hook lock with side pull handles

# PORTA VERTE HOME g H and J

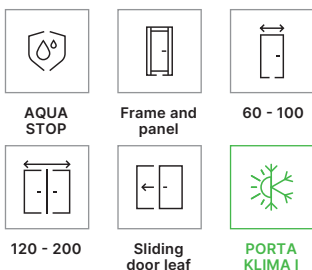

## Recommended door frames

### Rebated door frames:

- PORTA SYSTEM **HYDRO PROTECT™**
- PORTA SYSTEM
- PORTA SYSTEM 90°
- MINIMAX
- STEEL DOOR FRAMES

### Non-rebated door frames:

- PORTA SYSTEM ELEGANCE **HYDRO PROTECT™**
- PORTA SYSTEM ELEGANCE
- PORTA SYSTEM ELEGANCE 90°
- LEVEL

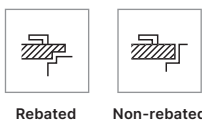

## Notes

- PN EN 14351-2 standard.
- Double doors are available in any door leaf size combinations.
- Magnetic lock is not available for a double door.
- In double non-rebated doors, there are two, active and passive, leaves in sizes from '60' to '100'.
- Black glazing is not available for sliding door leaves.
- The lower surface of stiles are protected against humidity thanks to TechnoPORTA AQUA STOP.



## Construction

Door leaves contain rails and stiles, slim panels and 4 mm thick, frosted, tempered glass. Combination of those depends on a model. Preparation for shortening (maximum 30 mm). Size '100' requires third hinge.

This door belongs to design line



Horizontal



## Accessories

Learn more [↗](#) 190

Check on the website





Finishes

See larger visualisations → 252

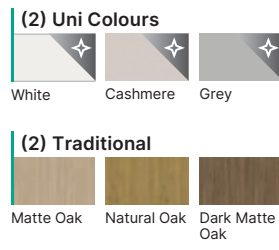

**PLEASE NOTE!** The number in brackets, e.g. (1) is the finish group  
Check the back flap of the cover.

Additionally

- size '100'

---

- ventilation undercut

---

- black glass panel 1 pc.

---

- acoustic threshold 'drop' seal

---

- rebated: PRIME hinges (extra charge to the door frame price)

---

- rebated: key lock and barrel hinges, black or gold colour

---

- rebated: magnetic lock and barrel hinges, black or gold colour

- rebated and non-rebated: magnetic lock with stainless steel faceplate

---

- non-rebated: black, white, or gold magnetic lock

---

- non-rebated: third 3D hinge (additional charge to the door frame price)

---

- non-rebated: 3D hinges, gold colour (extra charge to the door frame price)

---

- sliding doors - oblong pull handle

---

- sliding doors - hook lock with side pull handles

# PORTA VERTE HOME g D

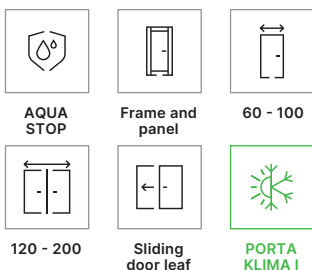

## Recommended door frames

### Rebated door frames:

- PORTA SYSTEM **HYDRO PROTECT™**
- PORTA SYSTEM
- PORTA SYSTEM 90°
- MINIMAX
- STEEL DOOR FRAMES

### Non-rebated door frames:

- PORTA SYSTEM ELEGANCE **HYDRO PROTECT™**
- PORTA SYSTEM ELEGANCE
- PORTA SYSTEM ELEGANCE 90°
- LEVEL

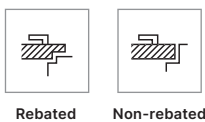

## Notes

- PN EN 14351-2 standard.
- Double doors are available in any door leaf size combinations.
- Magnetic lock is not available for a double door.
- In double non-rebated doors, there are two, active and passive, leaves in sizes from '60' to '100'.
- The lower surface of stiles are protected against humidity thanks to TechnoPORTA AQUA STOP.



## Construction

Door leaves contain rails and stiles, slim panels and 4 mm thick, frosted, tempered glass. Combination of those depends on a model. Preparation for shortening (maximum 30 mm). Size '100' requires third hinge.

This door belongs to design line



Horizontal



## Accessories

Learn more [↗](#) 190

Check on the website





D.0

D.2

D.7

Finishes

See larger visualisations [➔](#) 252

(1) Uni Colours



White



Grey

(1) Traditional



Andersen Pine



Wenge White



Walnut Whitened



Classic Oak



Dark Oak

(2) Uni Colours



White



Cashmere



Grey

(2) Traditional



Matte Oak



Natural Oak



California Oak



Dark Matte Oak

(1) Rustic



Norwegian Pine



Silver Acacia



Mauvella Oak



Golden Craft Oak



Catania Oak



Honey Acacia



Scarlet Oak

(2) Rustic



Scandinavian Oak



Light Hikora Jackson



English Oak Hamilton



Siberian Oak



Dark Hikora Jackson

**PLEASE NOTE!** The number in brackets, e.g. (1) is the finish group  
Check the back cover flap

Additionally

size '100'

ventilation undercut

acoustic threshold 'drop' seal

rebated: PRIME hinges (extra charge to the door frame price)

rebated: key lock and barrel hinges, black or gold colour

rebated: magnetic lock and barrel hinges, black or gold colour

rebated and non-rebated: magnetic lock with stainless steel faceplate

non-rebated: black, white, or gold magnetic lock

non-rebated: third 3D hinge (additional charge to the door frame price)

non-rebated: 3D hinges, gold colour (extra charge to the door frame price)

sliding doors - oblong pull handle

sliding doors - hook lock with side pull handles

# PORTA VERTE HOME g C, PORTA FIT g G

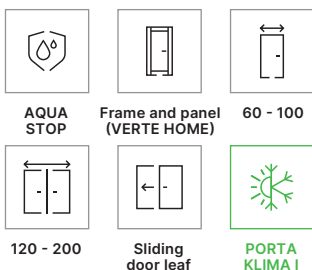

## Recommended door frames

### Rebated door frames:

- PORTA SYSTEM **HYDRO PROTECT™**
- PORTA SYSTEM
- PORTA SYSTEM 90°
- MINIMAX
- STEEL DOOR FRAMES

### Non-rebated door frames:

- PORTA SYSTEM ELEGANCE **HYDRO PROTECT™**
- PORTA SYSTEM ELEGANCE
- PORTA SYSTEM ELEGANCE 90°
- LEVEL

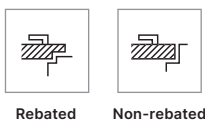

## Notes

- PN EN 14351-2 standard.
- Double doors are available in any door leaf size combinations.
- Magnetic lock is not available for a double door.
- There are two door leaves for non-rebated double leaf set: active and passive, in sizes '60' ÷ '100'. PORTA FIT passive leaf in sizes '30', '40', '50' (so called side panel), is available only in solid option.
- Preparation for shortening as standard - maximum 30 mm for PORTA VERTE HOME, 60 mm for PORTA FIT (chipboard core).
- The lower edge/stiles surface is protected against humidity in Techno-PORTA AQUA STOP technology.



## Construction

PORTA VERTE HOME: Door leaves contain rails and stiles, slim panels and 4 mm thick, frosted, tempered glass. Combination of those depends on a model. PORTA FIT: Honeycomb or hollow chipboard core reinforced with rails and stiles. The construction is skinned with HDF.

This door belongs to design line



## Horizontal



### Accessories

Learn more [↗](#) 190

Check on the website

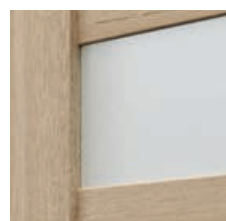

PORTA VERTE HOME: frosted tempered glass



PORTA FIT: bead with panel, NOTE: in the case of CPL, the bead is rounded



**Finishes**

See larger visualisations [↗ 252](#)

Applies to both models:



Only for PORTA VERTE HOME (C):

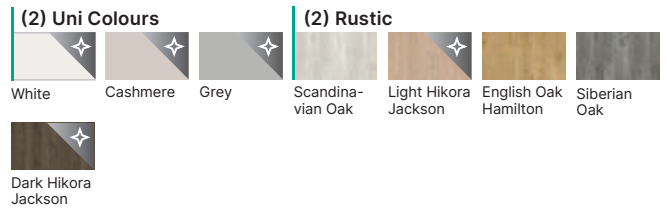

Only for PORTA FIT (G):

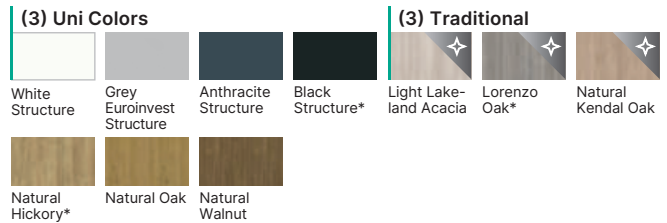

**PLEASE NOTE!** The number in brackets, e.g. (1) is the finish group. Check the back cover flap

**Additionally**

- size '100'
- ventilation undercut
- chipboard core (PORTA FIT)
- CPL 0,2 - marked colours \* (PORTA FIT)
- acoustic threshold 'drop' seal
- rebated: PRIME hinges (extra charge to the door frame price)
- rebated: key lock and barrel hinges, black or gold colour

- rebated: magnetic lock and barrel hinges, black or gold colour
- rebated and non-rebated: magnetic lock with stainless steel faceplate
- non-rebated: black, white, or gold magnetic lock
- non-rebated: third 3D hinge (additional charge to the door frame price)
- non-rebated: 3D hinges, gold colour (extral charge to the door frame price)
- sliding doors - oblong pull handle
- sliding doors - hook lock with side pull handles

# PORTA VERTE HOME g L, PORTA FIT g H

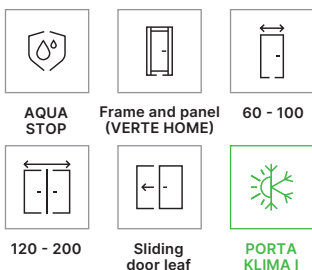

## Recommended door frames

### Rebated door frames:

- PORTA SYSTEM **HYDRO PROTECT™**
- PORTA SYSTEM
- PORTA SYSTEM 90°
- MINIMAX
- STEEL DOOR FRAMES

### Non-rebated door frames:

- PORTA SYSTEM ELEGANCE **HYDRO PROTECT™**
- PORTA SYSTEM ELEGANCE
- PORTA SYSTEM ELEGANCE 90°
- LEVEL

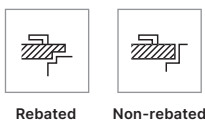

## Notes

- PN EN 14351-2 standard.
- Double doors are available in any door leaf size combinations.
- Magnetic lock is not available for a double door.
- In double non-rebated doors, there are two, active and passive, leaves in sizes from '60' to '100'.
- PORTA FIT passive leaf in sizes '30', '40', '50' (so called side panel), is available only in solid option.
- Preparation for shortening as standard - maximum 30 mm for PORTA VERTE HOME, 60 mm for PORTA FIT (chipboard core).
- The lower edge/stiles surface is protected against humidity in Techno-PORTA AQUA STOP technology.



## Construction

PORTA VERTE HOME: Door leaves contain rails and stiles, slim panels and 4 mm thick, frosted, tempered glass. Combination of those depends on a model. PORTA FIT: Honeycomb or hollow chipboard core reinforced with rails and stiles. The construction is skinned with HDF.

This door belongs to design line



## Horizontal



## Accessories

Learn more [↗](#) 190

Check on the website

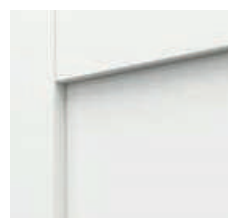

PORTA VERTE HOME: panel in model L.0



PORTA FIT: bead with panel, NOTE: in the case of CPL, the bead is rounded



**Finishes**

See larger visualisations → 252

Applies to both models:

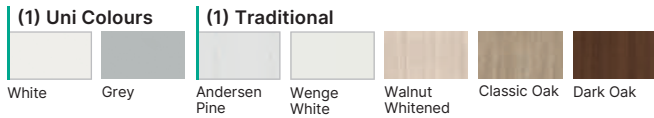

Only for PORTA VERTE HOME (L):

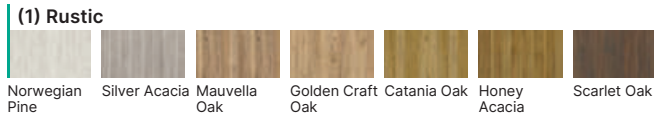
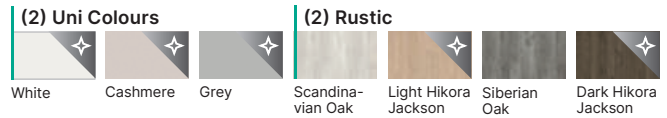

Only for PORTA FIT (H):

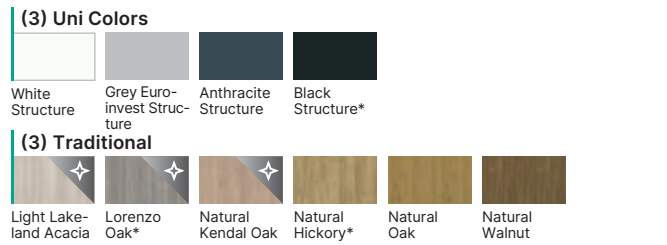

**PLEASE NOTE!** The number in brackets, e.g. (1) is the finish group. Check the back flap of the cover.

**Additionally**

- size '100'
- ventilation undercut
- transparent glass panel models from group L, 1 piece .
- chipboard core (PORTA FIT)
- CPL 0,2 - marked colours \* (PORTA FIT)
- acoustic threshold 'drop' seal
- rebated: PRIME hinges (extra charge to the door frame price)
- rebated: key lock and barrel hinges, black or gold colour

- rebated: magnetic lock and barrel hinges, black or gold colour
- rebated and non-rebated: magnetic lock with stainless steel faceplate
- non-rebated: black, white, or gold magnetic lock
- non-rebated: third 3D hinge (additional charge to the door frame price)
- non-rebated: 3D hinges, gold colour (extral charge to the door frame price)
- sliding doors - oblong pull handle
- sliding doors - hook lock with side pull handles

Traditional design.  
New interpretation.



# Rustic

Rustic is warmth and authenticity inspired by tradition. The division of doors from this line refer to classic, rustic constructions. Patterns with vertical or diagonal planking and elements, resembling wooden beams, dominate.



PORTA OSLO

Check [➤ 140](#)



NATURE OSLO

Check [➤ 140](#)



PORTA VECTOR PREMIUM

Check [➤ 142](#)



NATURE VECTOR

Check [➤ 142](#)



PORTA VIGO

Check [➤ 144](#)



PORTA VERTE HOME

Check [➤ 146](#)



PORTA CRAFT

Check [➤ 148](#)

## Additional options



Higher

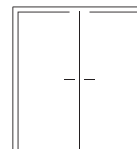

Double leaf

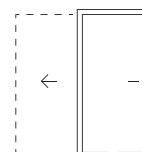

Sliding [➤ 170](#)

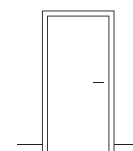

Skirting boards in many colours [➤ 231](#)



You can find more modification options on the pages with certain collection.

## Matching the Rustic line

See all door handles and knobs [➤ 190](#)

### Handles



Segura



Eleganto



Organic



Fioro

Check out the design lines on the website.



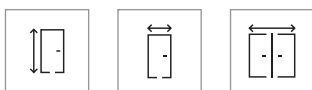

220

60 - 100

120 - 200

Sliding  
door leafPORTA  
KLIMA II\*\* possibility of  
changing the class  
from PORTA KLIMA I  
to PORTA KLIMA II,  
see page 4

### Recommended door frames

Door frames finished with Premium Lacquered veneer, Premium UV Paint and natural veneers:

#### Rebated door frames:

- PORTA SYSTEM **HYDRO PROTECT™** (PORTA OSLO)
- PORTA SYSTEM
- PORTA SYSTEM 90°

#### Non-rebated door frames:

- PORTA SYSTEM ELEGANCE **HYDRO PROTECT™** (PORTA OSLO)
- PORTA SYSTEM ELEGANCE
- PORTA SYSTEM ELEGANCE 90°
- LEVEL (PORTA OSLO)

#### Door frames with reverse rebate:

- PORTA SYSTEM with reverse rebate



Rebated



Non-rebated

with rever-  
se rebate

### Notes

- Standard PN EN 14351-2
- Double doors are available in any door leaf size combinations.
- Magnetic lock is not available for a double door.
- In double non-rebated doors, there are two, active and passive, leaves in sizes from '60' to '100'.
- PORTA OSLO: garage package available and change of core to chipboard (options at extra charge).

# PORTA OSLO, NATURE OSLO



PORTA OSLO 1, White, Segura black handle

### Construction

Honeycomb or hollow chipboard core reinforced with rails and stiles (at extra charge). The construction is skinned with HDF. Height '220' comes with hollow chipboard core and 3 hinges as standard. Size '100' requires third hinge. NATURE OSLO: the construction is skinned with a slim particle board which is finished with high quality natural veneer. The door leaf surface is protected by ecological water-based varnishes.

This door belongs  
to design line



Rustic



Accessories

Learn more [↗](#) 190

Check on  
the website



PORTA OSLO: close-up on  
milling, model 1, 2



NATURA OSLO: close-up of  
milling – visible substrate  
structure

## PORTA OSLO



## NATURE OSLO



### Finishes

See larger visualisations [➔](#) 252

#### PORTA OSLO:

##### Premium UV Paint



White

##### Premium Plus UV Paint



White



Cashmere



Grey



Sage

#### NATURE OSLO:

##### Natural Veneer



Oak 1

##### Natural Veneer Uni



White Oak

### Additionally

size '100'

door leaf height '220'

NEW garage set: see page 240

ventilation undercut or recuperative shortcut

hollow chipboard core

chipboard core

acoustic threshold 'drop' seal

SPECIAL OFFER - acoustic package

rebated: PRIME hinges (extra charge to the door frame price)

rebated: key lock and barrel hinges, black or gold colour

rebated: magnetic lock and barrel hinges, black or gold colour

rebated and non-rebated: magnetic lock with stainless steel faceplate

non-rebated: black, white, or gold magnetic lock

non-rebated: third 3D hinge (additional charge to the door frame price)

non-rebated: 3D hinges, gold colour (extra charge to the door frame price)

reverse rebate - extra charge added to door leaf price

reverse rebate - third 3D hinge (extra charge to door frame price)

reverse rebate - 3D hinges, gold colour (extra charge to door frame price)

sliding doors - oblong pull handle

sliding doors - hook lock with side pull handles



220



60 - 100

Sliding  
door leafPORTA  
KLIMA II\*

\* possibility of  
changing the class  
from PORTA KLIMA I  
to PORTA KLIMA II,  
see page 4

### Recommended door frames

Door frames finished with Premium Lacquered veneer, Premium Plus UV Paint, and natural veneers:

#### Rebated door frames:

- PORTA SYSTEM **HYDRO PROTECT™** (PORTA VECTOR PREMIUM)
- PORTA SYSTEM
- PORTA SYSTEM 90°

#### Non-rebated door frames:

- PORTA SYSTEM ELEGANCE **HYDRO PROTECT™** (PORTA VECTOR PREMIUM)
- PORTA SYSTEM ELEGANCE
- PORTA SYSTEM ELEGANCE 90°
- LEVEL (PORTA VECTOR PREMIUM)

#### Door frames with reverse rebate:

- PORTA SYSTEM with reverse rebate



Rebated



Non-rebated

with reverse  
rebate

### Notes

- PN EN 14351-2 standard.
- PORTA VECTOR PREMIUM: garage package available and change of core to chipboard (options at extra charge).

# PORTA VECTOR PREMIUM, NATURE VECTOR



PORTA VECTOR PREMIUM J, White, Lago silver handle

### Construction

Honeycomb or hollow chipboard core reinforced with rails and stiles (at extra charge). The construction is skinned with HDF. Height '220' comes with hollow chipboard core and 3 hinges as standard. Size '100' requires third hinge. NATURE VECTOR: the construction is skinned with a slim particle board which is finished with high quality natural veneer. The door leaf surface is protected by ecological water-based varnishes.

This door belongs  
to design line



### Rustic



#### Accessories

Learn more [↗](#) 190

Check on  
the website



PORTA VECTOR  
PREMIUM: close-up  
on milling



NATURA VECTOR:  
close-up of milling  
– visible substrate  
structure, wide mil-  
ling cutter



NATURA VECTOR:  
close-up of milling  
– visible substrate  
structure, narrow  
milling cutter

PORTA VECTOR PREMIUM



NATURE VECTOR



Finishes

See larger visualisations → 252

PORTA VECTOR PREMIUM:

Premium UV Paint



White

Premium Plus UV Paint



White



Cashmere



Grey



Sage

NATURE OSLO:

Natural Veneer



Oak 1

Natural Oak Satin Veneer



Winchester Oak

Natural Veneer Uni



White Oak

Additionally

size '100'

door leaf height '220'

NEW garage set: see page 240

ventilation undercut or recuperative shortcut

hollow chipboard core

chipboard core

acoustic threshold 'drop' seal

SPECIAL OFFER - acoustic package

rebated: PRIME hinges (extra charge to the door frame price)

rebated: key lock and barrel hinges, black or gold colour

rebated: magnetic lock and barrel hinges, black or gold colour

rebated and non-rebated: magnetic lock with stainless steel faceplate

non-rebated: black, white, or gold magnetic lock

non-rebated: third 3D hinge (additional charge to the door frame price)

non-rebated: 3D hinges, gold colour (extra charge to the door frame price)

reverse rebate - extra charge added to door leaf price

reverse rebate - third 3D hinge (extra charge to door frame price)

reverse rebate - 3D hinges, gold colour (extra charge to door frame price)

sliding doors - oblong pull handle

sliding doors - hook lock with side pull handles

NEW

HYDRO PROTECT™

ACOUSTIC PACKAGE



60 - 100



120 - 200



Sliding door leaf



PORTA KLIMA I

### Recommended door frames

#### Rebated door frames:

- PORTA SYSTEM **HYDRO PROTECT™**
- PORTA SYSTEM
- PORTA SYSTEM 90°
- MINIMAX
- STEEL DOOR FRAMES

#### Non-rebated door frames:

- PORTA SYSTEM ELEGANCE **HYDRO PROTECT™**
- PORTA SYSTEM ELEGANCE
- PORTA SYSTEM ELEGANCE 90°
- LEVEL

#### Door frames with reverse rebate:

- PORTA SYSTEM with reverse rebate



Rebated



Non-rebated



with reverse rebate

### Notes

- PN EN 14351-2 standard.
- Double doors are available in any door leaf size combinations.
- Magnetic lock is not available for a double door.
- Passive leaf sizes: from '60' to '100'. Passive door leaves (side panels) in sizes '30', '40', '50' available only in solid option (without decorative applications).
- In double non-rebated doors, there are two, active and passive, leaves in sizes from '60' to '100'.

# PORTA VIGO



Porta VIGO V1, Catania Oak, Organic Anthracite Structure Handle

### Construction

Honeycomb or chipboard core reinforced with rails and stiles (option at extra charge). The construction is skinned with HDF. Chipboard core have preparation for shortening as standard. Size '100' requires third hinge.

This door belongs to design line



## Rustic



### Accessories

Learn more [↗](#) 190

Check on the website



## PLEASE NOTE

**UNUSUAL INTERIOR DESIGN OPTIONS WITH LEVEL DOOR FRAMES**

The LEVEL door frame panel is available in heights of 20 cm or 100 cm, and grain direction can be vertical or horizontal.



V.1



V.2



V.3

## Finishes

See larger visualisations [➔](#) 252**(1) Rustic**

Golden Craft Oak Mauvella oak Catania Oak

**(2) Rustic**

Light Hikora Jackson English Oak Hamilton Dark Hikora Jackson

**PLEASE NOTE!** The number in brackets, e.g. (1) is the finish group  
Check the back flap of the cover.

## Additionally

size '100'

hollow chipboard core

chipboard core

NEW garage set: see page 240

ventilation undercut

acoustic threshold 'drop' seal

SPECIAL OFFER - acoustic package

rebated: key lock and barrel hinges, black or gold colour

rebated: PRIME hinges (extra charge to the door frame price)

rebated: magnetic lock and barrel hinges, black or gold colour

rebated and non-rebated: magnetic lock with stainless steel faceplate

non-rebated: black, white, or gold magnetic lock

non-rebated: third 3D hinge (additional charge to the door frame price)

non-rebated: 3D hinges, gold colour (extra charge to the door frame price)

reverse rebate - extra charge added to door leaf price

reverse rebate - third 3D hinge (extra charge to door frame price)

reverse rebate - 3D hinges, gold colour (extra charge to door frame price)

sliding doors - oblong pull handle

sliding doors - hook lock with side pull handles

# PORTA VERTE HOME g E and M

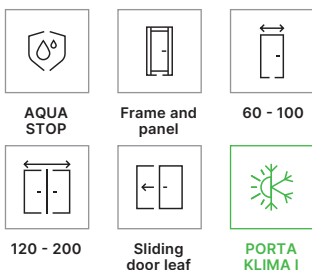

## Recommended door frames

### Rebated door frames:

- PORTA SYSTEM **HYDRO PROTECT™**
- PORTA SYSTEM
- PORTA SYSTEM 90°
- MINIMAX
- STEEL DOOR FRAMES

### Non-rebated door frames:

- PORTA SYSTEM ELEGANCE **HYDRO PROTECT™**
- PORTA SYSTEM ELEGANCE
- PORTA SYSTEM ELEGANCE 90°
- LEVEL

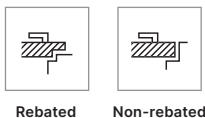

Rebated

Non-rebated

## Notes

- PN EN 14351-2 standard.
- Double doors are available in any door leaf size combinations.
- Magnetic lock is not available for a double door.
- In double non-rebated doors, there are two, active and passive, leaves in sizes from '60' to '100'.
- Model E.0 with the blackboard is not available in size '100'.
- The lower surface of stiles are protected against humidity thanks to TechnoPORTA AQUA STOP.



PORTA VERTE HOME M.1, Mauvella Oak, Segura silver handle

## Construction

Door leaves contain rails and stiles, slim panels and 4 mm thick, frosted or transparent tempered glass. Combination of those depends on a model. Models M.1 and M.2 are available with transparent glass pane. Preparation for shortening (maximum 30 mm). Size '100' requires third hinge.

This door belongs  
to design line



Rustic



## Accessories

Learn more → 190

Check on  
the website





Finishes

See larger visualisations [➔](#) 252

(1) Uni Colours



White Grey Fjord Olive

(2) Uni Colours



White Cashmere Grey

(2) Traditional

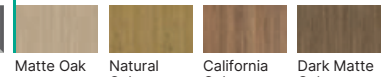

Matte Oak Natural Oak California Oak Dark Matte Oak

(1) Rustic



Norwegian Pine Silver Acacia Mauvella Oak Golden Craft Oak Catania Oak Honey Acacia Scarlet Oak

(2) Rustic



Scandinavian Oak Light Hikora Jackson Siberian Oak Dark Hikora Jackson

**PLEASE** The number in brackets, e.g. (1) is the finish group

**NOTE!** Check the back cover flap

Additionally

size '100'

ventilation undercut

acoustic threshold 'drop' seal

rebated: PRIME hinges (extra charge to the door frame price)

rebated: key lock and barrel hinges, black or gold colour

rebated: magnetic lock and barrel hinges, black or gold colour

rebated and non-rebated: magnetic lock with stainless steel faceplate

non-rebated: black, white, or gold magnetic lock

non-rebated: third 3D hinge (additional charge to the door frame price)

non-rebated: 3D hinges, gold colour (extra charge to the door frame price)

sliding doors - oblong pull handle

sliding doors - hook lock with side pull handles

AQUA  
STOPFrame and  
panel

60 - 100



120 - 200

Sliding  
door leafPORTA  
KLIMA I

### Recommended door frames

#### Rebated door frames:

- PORTA SYSTEM **HYDRO PROTECT™**
- PORTA SYSTEM
- PORTA SYSTEM 90°

#### Non-rebated door frames:

- PORTA SYSTEM ELEGANCE **HYDRO PROTECT™**
- PORTA SYSTEM ELEGANCE
- PORTA SYSTEM ELEGANCE 90°
- LEVEL

#### Door frames with reverse rebate:

- PORTA SYSTEM with reverse rebate



Rebated



Non-rebated

with rever-  
se rebate

### Notes

- PN EN 14351-2 standard.
- Double doors are available in any door leaf size combinations.
- Magnetic lock is not available for a double door.
- In double non-rebated doors, there are two, active and passive, leaves in sizes from '60' to '100'.
- The lower surface of stiles are protected against humidity thanks to TechnoPORTA AQUA STOP.

# PORTA CRAFT



PORTA CRAFT C.2, Light Hikora Jackson, Euphoria black handle

### Construction

Door leaves contain rails and stiles, slim panels and 6 mm thick, frosted or transparent tempered glass. Combination of those depends on a model. Preparation for shortening maximum 60 mm. Size '100' requires third hinge.

This door belongs  
to design line



## Rustic



### Accessories

Learn more [↗](#) 190

Check on  
the website





Finishes

See larger visualisations → 252

(1) Traditional

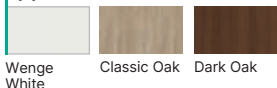

(1) Rustic

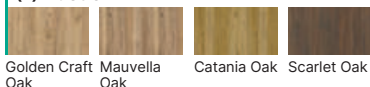

(2) Traditional

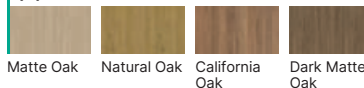

(2) Rustic

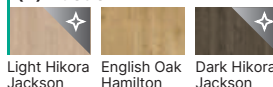

**PLEASE** The number in brackets, e.g. (1) is the finish group  
**NOTE!** Check the back cover flap

Additionally

- size '100'
- ventilation undercut
- acoustic threshold 'drop' seal
- rebated: PRIME hinges (extra charge to the door frame price)
- rebated: key lock and barrel hinges, black or gold colour
- rebated: magnetic lock and barrel hinges, black or gold colour
- rebated and non-rebated: magnetic lock with stainless steel faceplate

- non-rebated: black, white, or gold magnetic lock
- non-rebated: third 3D hinge (additional charge to the door frame price)
- non-rebated: 3D hinges, gold colour (extral charge to the door frame price)
- reverse rebate - extra charge added to door leaf price
- reverse rebate - third 3D hinge (extra charge to door frame price)
- reverse rebate - 3D hinges, gold colour (extra charge to door frame price)
- sliding doors - oblong pull handle
- sliding doors - hook lock with side pull handles

Vertical accent.  
Optical enlargement.



# Vertical

Doors with vertical glass that optically enlarges the interior. The design line is also distinguished by the vertical division of the door leaf – most often in the form of a narrow glass pane. The line running along the door handle is a subtle accent that fashions the space.



PORTA FOCUS PREMIUM

Check [➤ 156](#)



NATURE VECTOR

Check [➤ 152](#)

Similar:  
PORTA VECTOR PREMIUM [➤ 152](#)



PORTA LINE

Check [➤ 154](#)

Similar:  
PORTA RESIST [➤ 154](#)



PORTA FOCUS

Check [➤ 158](#)

Similar:  
PORTA FOCUS PREMIUM [➤ 156](#)  
PORTA RESIST [➤ 154](#)  
PORTA LOFT [➤ 160](#)  
NATURE SPACE [➤ 156](#)



PORTA FOCUS PREMIUM

Check [➤ 156](#)

Similar:  
PORTA FOCUS [➤ 158](#)  
NATURE SPACE [➤ 156](#)



PORTA LOFT

Check [➤ 160](#)

Similar:  
PORTA FOCUS PREMIUM [➤ 156](#)  
PORTA FOCUS [➤ 158](#)  
PORTA RESIST [➤ 154](#)  
NATURE SPACE [➤ 156](#)

## Additional options



Higher



Decorative slats  
[➤ 210](#)

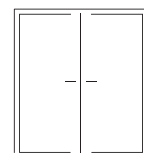

Double leaf

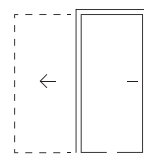

Sliding [➤ 170](#)

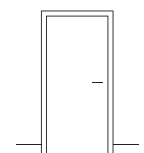

Skirting boards  
in many colours [➤ 231](#)



You can find more modification options on the pages with certain collection.

## Matching the Vertical line

See all door handles and knobs [➤ 190](#)

### Handles



Lago



Fiore



MAGRO SLIM



Fresco

Check out the design lines on the website.



# PORTA VECTOR PREMIUM, NATURE VECTOR



220



60 - 100



120 - 200

Sliding  
door leafPORTA  
KLIMA II\*

\* possibility of  
changing the class  
from PORTA KLIMA I  
to PORTA KLIMA II,  
see page 4

## Recommended door frames

Door frames finished with Premium  
Lacquered veneer,  
Premium Plus UV Paint  
and natural veneers:

### Rebated door frames:

- PORTA SYSTEM **HYDRO PROTECT™**  
(PORTA VECTOR PREMIUM)
- PORTA SYSTEM
- PORTA SYSTEM 90°

### Non-rebated door frames:

- PORTA SYSTEM ELEGANCE  
**HYDRO PROTECT™** (PORTA VECTOR  
PREMIUM)
- PORTA SYSTEM ELEGANCE
- PORTA SYSTEM ELEGANCE 90°
- LEVEL (PORTA VECTOR PREMIUM)

### Door frames with reverse rebate:

- PORTA SYSTEM with reverse rebate



Rebated



Non-rebated

with rever-  
se rebate

## Notes

- PN EN 14351-2 standard.
- Magnetic lock is not available for a double door.
- In double non-rebated doors, there are two, active and passive, leaves in sizes from '60' to '100'.
- Passive door leaf (side panel) in sizes '30', '40', '50' without milling (NATURE VECTOR).
- PORTA VECTOR PREMIUM: garage package available and change of core to chipboard (options at extra charge).



PORTA VECTOR PREMIUM B, Cashmere, Eleganto black handle

## Construction

Honeycomb or hollow chipboard core reinforced with rails and stiles (at extra charge). The construction is skinned with HDF. Height '220' comes with hollow chipboard core and 3 hinges as standard. Size '100' requires third hinge. NATURE VECTOR: the construction is skinned with a slim particle board which is finished with high quality natural veneer. The door leaf surface is protected by ecological water-based varnishes.

This door belongs  
to design line



## Vertical



### Accessories

Learn more [↗](#) 190

Check on  
the website



NATURE VECTOR:  
close-up on milling -  
wide milling cutter



NATURE VECTOR:  
close-up on milling -  
narrow milling cutter



PORTA VECTOR:  
decorative milling  
close-up

PORTA VECTOR PREMIUM



B

NATURE VECTOR



B

Finishes

See larger visualisations → 252

PORTA VECTOR PREMIUM:

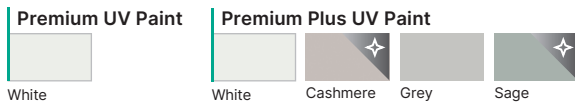

NATURE VECTOR:

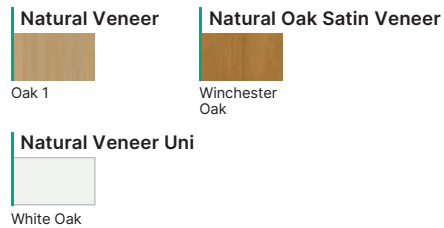

Additionally

- size '100'
- door leaf height '220'
- NEW garage set: see page 240
- ventilation undercut or recuperative shortcut
- hollow chipboard core
- chipboard core
- acoustic threshold 'drop' seal
- SPECIAL OFFER - acoustic package
- rebated: PRIME hinges (extra charge to the door frame price)
- rebated: key lock and barrel hinges, black or gold colour

- rebated: magnetic lock and barrel hinges, black or gold colour
- rebated and non-rebated: magnetic lock with stainless steel faceplate
- non-rebated: black, white, or gold magnetic lock
- non-rebated: third 3D hinge (additional charge to the door frame price)
- non-rebated: 3D hinges, gold colour (extra charge to the door frame price)
- reverse rebate - extra charge added to door leaf price
- reverse rebate - third 3D hinge (extra charge to door frame price)
- reverse rebate - 3D hinges, gold colour (extra charge to door frame price)
- sliding doors - oblong pull handle
- sliding doors - hook lock with side pull handles

# PORTA LINE, NATURE LINE, PORTA RESIST with decorative inlays

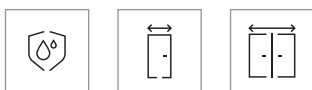
AQUA  
STOP

60 - 100

120 - 200

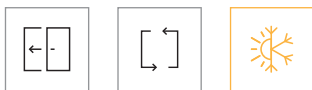
Sliding  
door leafTechnoPORTA  
TechnologyPORTA  
KLIMA II+

\* possibility of changing the class from  
PORTA KLIMA I to PORTA KLIMA II,  
see page 4

## Recommended door frames

### Rebated door frames:

- PORTA SYSTEM **HYDRO PROTECT™**  
(PORTA LINE, PORTA RESIST)
- PORTA SYSTEM
- PORTA SYSTEM 90°

### Non-rebated door frames:

- PORTA SYSTEM ELEGANCE  
**HYDRO PROTECT™** (PORTA LINE,  
PORTA RESIST)
- PORTA SYSTEM ELEGANCE
- PORTA SYSTEM ELEGANCE 90°
- LEVEL (PORTA LINE)

### Door frames with reverse rebate:

- PORTA SYSTEM with reverse rebate



Rebated

Non-rebated

with rever-  
se rebate

## Notes

- PN EN 14351-2 standard.
- Double doors are available in any door leaf size combinations.
- Magnetic lock is not available for a double door.
- Passive leaf sizes: from '60' to '100'. Passive door leaves (side panels) in sizes '30', '40', '50' available only in solid option (without decorative applications) (PORTA LINE, PORTA RESIST).
- In double non-rebated doors, there are two, active and passive, leaves in sizes from '60' to '100'.
- Lower edge is protected against humidity in TechnoPORTA AQUA STOP technology (PORTA LINE, PORTA RESIST).



PORTA LINE B.1, White, Lago black handle

## Construction

Honeycomb or hollow chipboard core reinforced with rails and stiles (at extra charge). The construction is skinned with HDF. Chipboard core have preparation for shortening as standard. Size '100' requires third hinge. NATURE LINE: height '220' includes hollow chipboard core and three hinges.

This door belongs  
to design line



## Vertical



## Accessories

Learn more [↗](#) 190

Check on  
the website



## PORTA LINE, PORTA RESIST with decorative inlay

Extra options for this collection:



TechnoPORTA Technology



B.1



B.1

## NATURE LINE

Extra options for this collection:



220



B.1

### Details

Door leaves are complemented with decorative inlays in silver, golden or black colour, width 6 mm. There is lipping ABS on the side edges of the doors finished with CPL or Synchronous Board. PORTA RESIST: The door leaf is skinned with a 3 mm synchronous structure board, and the door frame is finished with a matching 0.2 mm CPL laminate. NATURE LINE: the construction is skinned with a slim particle board which is finished with high quality natural veneer. The door leaf surface is protected by ecological water-based varnishes.

### Finishes

See larger visualisations → 252

#### PORTA LINE:

##### (1) Uni Colours



White



Grey

##### (1) Traditional



Andersen Pine



Wenge White



Walnut Whitened



Classic Oak



Dark Oak

##### (2) Uni Colours



White



Cashmere



Grey

##### (2) Modern



Salvador Bleached Oak



Salvador Light Oak



Natural Arles Oak

##### (4) Uni Colours



Cashmere



Sandy Grey



Dusty Grey

#### PORTA RESIST with decorative inlays:

##### (4) Modern



White Casella Oak



Natural Casella Oak



Brown Casella Oak



Casella Marone Oak

##### (4) Rustic



Halifax Natural



Halifax Tabak



Sherman Oak

#### NATURE LINE:

##### Natural Veneer



Oak 1

##### Natural Oak Satin Veneer



Light Oak



Winchester Oak



Tabacco



Brown Oak



Mocca

##### Natural Veneer Select Matte



Oak



Dark Walnut

##### Natural Veneer Uni



White Oak



Black

##### (2) Traditional



Toffe Arles Oak



Dark Arles Oak



Havana Oak



Matte Oak



Natural Oak



California Oak



Dark Matte Oak

##### (3) Traditional



Lorenzo Oak\*



Natural Kendal Oak



Natural Hickory\*



Natural Oak



Natural Walnut



Vicenza Oak



Grey Vicenza Oak

##### (3) Modern



Lorenzo Oak\*



Natural Kendal Oak



Natural Hickory\*



Natural Oak



Natural Walnut



Vicenza Oak



Grey Vicenza Oak

**PLEASE NOTE!** The number in brackets, e.g. (1) is the finish group  
Check the back cover flap

### Additionally

size '100'

hollow chipboard core

chipboard core

NEW garage set: see page 240

ventilation undercut or recuperative shortcut

acoustic threshold 'drop' seal

SPECIAL OFFER - acoustic package

rebated: key lock and barrel hinges, black or gold colour

rebated: PRIME hinges (extra charge to the door frame price)

rebated: magnetic lock and barrel hinges, black or gold colour

rebated and non-rebated: magnetic lock with stainless steel faceplate

non-rebated: black, white, or gold magnetic lock

non-rebated: third 3D hinge (additional charge to the door frame price)

non-rebated: 3D hinges, gold colour (extra charge to the door frame price)

reverse rebate - extra charge added to door leaf price

reverse rebate - third 3D hinge (extra charge to door frame price)

reverse rebate - 3D hinges, gold colour (extra charge to door frame price)

sliding doors - oblong pull handle

sliding doors - hook lock with side pull handles

CPL 0,2 - marked colours\*

CPL 0,2 - UNI MATTE GROUP

door leaf height '220'

Natural veneer, White Oak, Satin

Natural veneer, Select: Black



60 - 100

120 - 200

Sliding  
door leafPORTA  
KLIMA I

### Recommended door frames

Door frames finished with Premium Lacquered veneer, Premium Plus UV Paint and natural veneers:

#### Rebated door frames:

- PORTA SYSTEM **HYDRO PROTECT™** (PORTA FOCUS PREMIUM)
- PORTA SYSTEM
- PORTA SYSTEM 90°

#### Non-rebated door frames:

- PORTA SYSTEM ELEGANCE **HYDRO PROTECT™** (PORTA FOCUS PREMIUM)
- PORTA SYSTEM ELEGANCE
- PORTA SYSTEM ELEGANCE 90°

#### Door frames with reverse rebate:

- PORTA SYSTEM with reverse rebate



Rebated

Non-rebated

with reverse  
rebate

### Notes

- PN EN 14351-2 standard.
- Magnetic lock is not available for a double door.
- In double non-rebated doors, there are two, active and passive, leaves in sizes from '60' to '100'.
- Fixed size of glass, model 4.A.
- Ventilation undercut is not available for reverse rebate (applies to models 4.B, 4.C).
- PORTA FOCUS PREMIUM model 4.is available only with hollow chipboard core (without extra charge).
- PORTA FOCUS PREMIUM: option to change the core to solid chipboard (optionally at extra charge).
- NATURA SPACE: ventilation undercut and recuperation shortcut are not available.



### Accessories

Learn more [↗](#) 190

# PORTA FOCUS PREMIUM, NATURE SPACE



PORTA FOCUS Premium 4.A, White, ELEGANTO black handle

### Construction

PORTA FOCUS: honeycomb or at extra charge chipboard. NATURE SPACE: hollow chipboard core. The construction is skinned with HDF. Size '100' requires third hinge. NATURE SPACE: construction made of laminated softwood.

This door belongs to design line



### Vertical

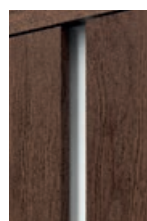

NATURE SPACE door with frosted glazing



PORTA FOCUS PREMIUM: glass - door panel joint non-rebated door leaf



PORTA FOCUS PREMIUM: glass - door panel joint, rebated door leaf

Check on the website



PORTA FOCUS PREMIUM  
models with glass pane



4.A, black glass  
pane also available



4.B



4.C



solid model

5.A

NATURE SPACE models  
with glass pane



G.1, also available  
with black glass  
pane



F.1



H.1

Details

Glazed models come with 8 mm thick, frosted laminated safety glass pane.  
Black glazing is available for model 4.A and G.1 (optionally at extra charge).

Finishes

See larger visualisations → 252

PORTA FOCUS PREMIUM:

Premium UV Paint



White

Premium Plus UV Paint



White

NATURE SPACE

Natural Veneer



Oak 1

Natural Oak Satin Veneer



Light Oak



Winchester  
Oak



Tabacco



Brown Oak



Mocca

Natural Veneer Select Matte



Oak



Dark Walnut

Natural Veneer Uni



White Oak

Additionally

size '100'

hollow chipboard core

chipboard core

black glazing - model 4.A, G.1

ventilation undercut or recuperative shortcut

acoustic threshold 'drop' seal (models of group 5)

SPECIAL OFFER - acoustic package (models of group 5)

Natural veneer, White Oak, Satin

rebated: key lock and barrel hinges, black or gold colour

rebated: PRIME hinges (extra charge to the door frame price)

rebated: magnetic lock and barrel hinges, black or gold colour

rebated and non-rebated: magnetic lock with stainless steel faceplate

non-rebated: black, white, or gold magnetic lock

non-rebated: third 3D hinge (additional charge to the door frame price)

non-rebated: 3D hinges, gold colour (extra charge to the door frame price)

reverse rebate - extra charge added to door leaf price

reverse rebate - third 3D hinge (extra charge to door frame price)

reverse rebate - 3D hinges, gold colour (extra charge to door frame price)

sliding doors - oblong pull handle

sliding doors - hook lock with side pull handles

# PORTA FOCUS



60 - 100

120 - 200

Sliding  
door leafPORTA  
KLIMA I

## Recommended door frames

### Rebated door frames:

- PORTA SYSTEM **HYDRO PROTECT™**
- PORTA SYSTEM
- PORTA SYSTEM 90°

### Non-rebated door frames:

- PORTA SYSTEM ELEGANCE **HYDRO PROTECT™**
- PORTA SYSTEM ELEGANCE
- PORTA SYSTEM ELEGANCE 90°
- LEVEL

### Door frames with reverse rebate:

- PORTA SYSTEM with reverse rebate



Rebated

Non-rebated

with reverse  
rebate

## Notes

- PN EN 14351-2 standard.
- Double doors are available in any door leaf size combinations.
- Magnetic lock is not available for a double door.
- Passive leaf sizes: from '60' to '100'. Passive door leaves (side panels) in sizes '30', '40', '50' available only in solid option (without decorative applications).
- In double non-rebated doors, there are two, active and passive, leaves in sizes from '60' to '100'.
- 4. B models available only with hollow chipboard core (without extra charge).
- Fixed size of glass - only group 2, model 4.A.



PORTA FOCUS 4.A, Dark Oak Matte, LEVEL door frame, Lago black handle

## Construction

Honeycomb or hollow chipboard core reinforced with rails and stiles (at extra charge). The construction is skinned with HDF. Size '100' requires third hinge.

This door belongs  
to design line



## Vertical



## Accessories

Learn more [↗](#) 190

Check on  
the website

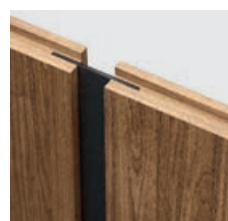

glass - door panel joint rebated door leaf



glass - door panel joint non-rebated door leaf



### Details

Glazed models come with 8 mm thick, frosted laminated safety glass panel. Black glazing is available for model 4.A (optionally at extra charge). There is lipping ABS on the side edges of the doors finished with CPL.

### Finishes

See larger visualisations → 252

#### (1) Traditional

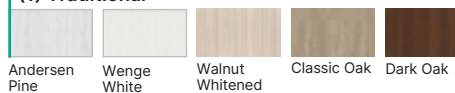

#### (2) Uni Colours

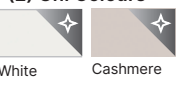

#### (3) Traditional



#### (2) Modern

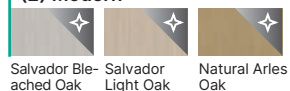

#### (3) Rustic



#### (4) Uni colours



#### (2) Traditional

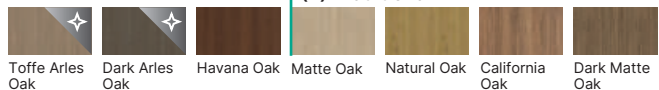

#### (3) Uni Colours

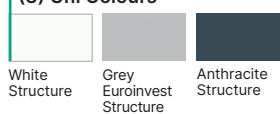

#### (3) Modern

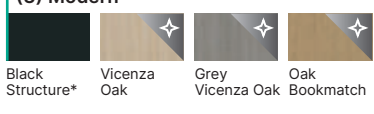

**PLEASE NOTE!** The number in brackets, e.g. (1) is the finish group  
Check the back cover flap

### Additionally

size '100'

hollow chipboard core

chipboard core

black glass panel - model 4.A

ventilation undercut

CPL 0,2 - marked colours\*

rebated: key lock and barrel hinges, black or gold colour

rebated: PRIME hinges (extra charge to the door frame price)

rebated: magnetic lock and barrel hinges, black or gold colour

rebated and non-rebated: magnetic lock with stainless steel faceplate

non-rebated: black, white, or gold magnetic lock

non-rebated: third 3D hinge (additional charge to the door frame price)

non-rebated: 3D hinges, gold colour (extra charge to the door frame price)

reverse rebate - extra charge added to door leaf price

reverse rebate - third 3D hinge (extra charge to door frame price)

reverse rebate - 3D hinges, gold colour (extra charge to door frame price)

sliding doors - oblong pull handle

sliding doors - hook lock with side pull handles

# PORTA RESIST, PORTA LOFT

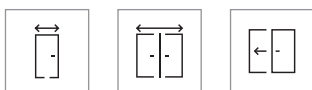

60 - 100

120 - 200  
(PORTA  
RESIST)Sliding door  
(PORTA  
RESIST)PORTA  
KLIMA II\*

\* possibility of  
changing the class  
from PORTA KLIMA I  
to PORTA KLIMA II,  
see page 4

## Recommended door frames

### Rebated door frames (PORTA RESIST):

- PORTA SYSTEM **HYDRO PROTECT™**
- PORTA SYSTEM
- PORTA SYSTEM 90°

### Non-rebated door frames:

- PORTA SYSTEM ELEGANCE  
**HYDRO PROTECT™**
- PORTA SYSTEM ELEGANCE
- PORTA SYSTEM ELEGANCE 90°

### Door frames with reverse rebate:

- PORTA SYSTEM with reverse rebate

Rebated  
(PORTA  
RESIST)

Non-rebated

with reverse  
rebate

## Notes

- PN EN 14351-2 standard.
- Double doors are available in any door leaf size combinations.
- Magnetic lock is not available for a double door.
- Passive leaf sizes: from '60' to '100'. Passive door leaves (side panels) in sizes '30', '40', '50' available only in solid option (without decorative applications).
- In double non-rebated doors, there are two, active and passive, leaves in sizes from '60' to '100'.
- 4. B models available only with hollow chipboard core (without extra charge).
- Fixed size of glass, model 4.A.



PORTA LOFT 4.A, Halifax Natural Oak, Black glass pane, Eleganto black handle

## Construction

Honeycomb or hollow chipboard core reinforced with rails and stiles (at extra charge). The construction is skinned with HDF. Size '100' requires third hinge.

This door belongs  
to design line



## Vertical



### Accessories

Learn more [↗](#) 190

Check on  
the website



PORTA RESIST:  
glass - door panel  
joint rebated door  
leaf



glass - door panel  
joint non-rebated  
door leaf



PORTA LOFT: black  
lipping, door frame,  
and accessories

## PORTA RESIST with glazing

4.A, black glass pane  
also available

4.B

## PORTA LOFT with glazing

4.A, black glass pane  
also available

4.B

## Details

8 mm thick, frosted laminated safety glass. Black glazing is available for model 4.A (optionally at extra charge). There is liping ABS on the side edges of the doors finished with CPL. PORTA LOFT: door frame, hinges, lock, and liping ABS (for all finishes) are black.

## Finishes

See larger visualisations → 252

## PORTA RESIST:

## (4) Modern

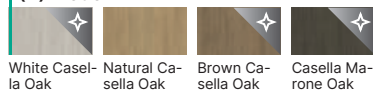

White Casella Oak

Natural Casella Oak

Brown Casella Oak

Casella Marone Oak

## (4) Rustic

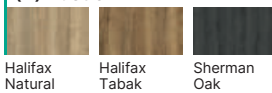

Halifax Natural

Halifax Tabak

Sherman Oak

## (2) Traditional

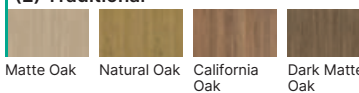

Matte Oak

Natural Oak

California Oak

Dark Matte Oak

## (2) Rustic



Light Hikora Jackson

English Oak Hamilton

Siberian Oak

## PORTA LOFT:

## (1) Rustic

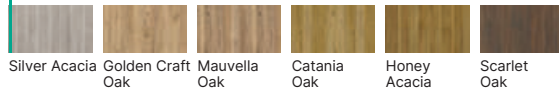

Silver Acacia

Golden Craft Oak

Mauvella Oak

Catania Oak

Honey Acacia

Scarlet Oak

## (3) Traditional



Dark Hikora Jackson

Light Lakeland Acacia

Lorenzo Oak\*

Natural Kendal Oak

Natural Hickory\*

Natural Oak

Natural Walnut

## (3) Rustic



Golden Craft Oak

## (4) Uni Colours



Cashmere

Sandy Grey

Dusty Grey

## (4) Traditional



Sand Oak

## (4) Rustic

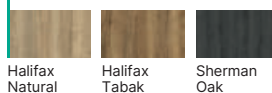

Halifax Natural

Halifax Tabak

Sherman Oak

**PLEASE NOTE!** The number in brackets, e.g. (1) is the finish group. Check the back cover flap

## Additionally

size '100'

hollow chipboard core

chipboard core

black glass panel - model 4.A

ventilation undercut

CPL 0,2 - marked colours\*

CPL 0,2 - UNI MATTE GROUP

rebated: key lock and barrel hinges, black or gold colour

rebated: PRIME hinges (extra charge to the door frame price)

rebated: magnetic lock and barrel hinges, black or gold colour

rebated and non-rebated: magnetic lock with stainless steel faceplate

non-rebated: black, white, or gold magnetic lock

non-rebated: third 3D hinge (additional charge to the door frame price)

non-rebated: 3D hinges, gold colour (extra charge to the door frame price)

reverse rebate - extra charge added to door leaf price

reverse rebate - third 3D hinge (extra charge to door frame price)

reverse rebate - 3D hinges, gold colour (extra charge to door frame price)

sliding doors - oblong pull handle

sliding doors - hook lock with side pull handles

Maximum transparency  
and more light



PORTA LOFT STEEL, model 2, Champagne, graphite smoked glass and ribbed glass.

# Glass

Glass doors opening the interior to light. The design line offers transparent door leaves with a metal frame (steel or aluminum) or with classic, warm wooden frame. It's modernity that will work in any home – and is also safe for children.



STEEL PORTA LOFT

Check [➤ 164](#)



PORTA LUMIA

Check [➤ 166](#)



PORTA GLASS

Check [➤ 168](#)

## Additional options



Higher

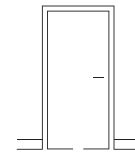

Skirting boards  
in many colours [➤ 231](#)



You can find more modification options  
on the pages with certain collection.

## Matching to the Glass line

See all door hardware [➤ 190](#)

### Hardware



ESTIMA door pull



Glass handle

Check out the  
design lines on  
the website.





80 - 90

PORTA  
KLIMA I

### Recommended door frames

#### Non-rebated door frames:

- A steel door frame dedicated to this product



Non-rebated

### Notes

- PN EN 14351-2 standard.
- Check dimensions [↗ 254](#)

### Full set

- Steel door leaf.
- Dedicated steel door frame.
- Set of hardware: three hinges, door pull, magnet.

# STEEL PORTA LOFT



PORTA LOFT STEEL, model 2, Champagne, graphite smoked glass and ribbed glass.

### Construction

Steel door leaf in following colours: Black structure, White structure, Anthracite structure, or Champagne (powder paint coated). Rails and stiles with a cross-section of 40 mm by 20 mm, internal muntins of width 15 mm. Transparent, frosted, safety laminated glass, 6 mm thick, or, for an additional charge, smoked graphite, 6 mm thick, grooved, 4 mm thick.

This door belongs  
to design line



### Glass



Champagne  
colour, grooved  
glass



White structure  
colour, transpa-  
rent glass



Anthracite  
colour, forsted  
glass



Black structure  
colour, smoked  
graphite glass

Check on  
the website



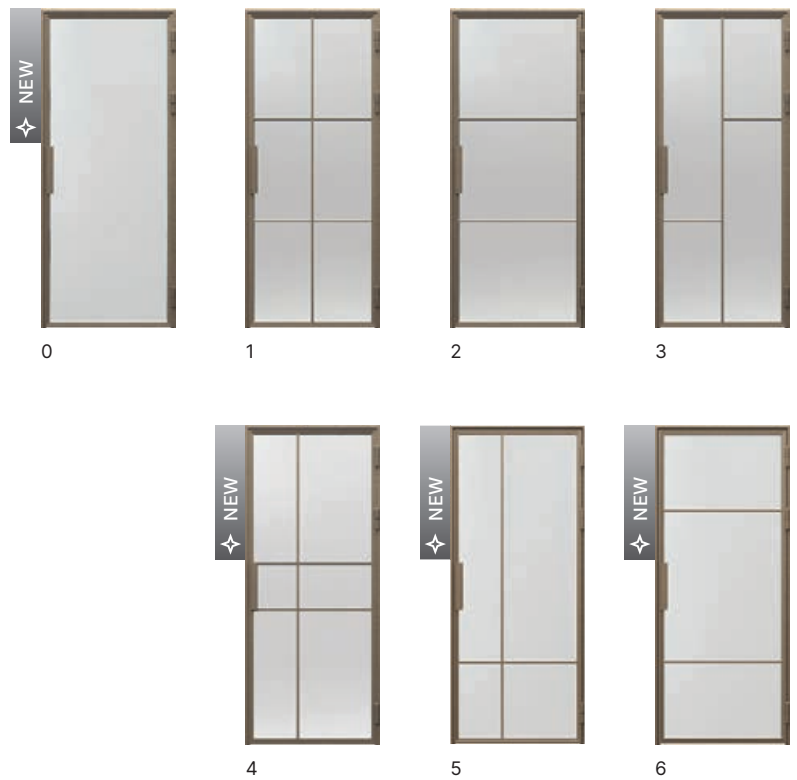

Glazing

See larger visualisations [➤ 205](#)

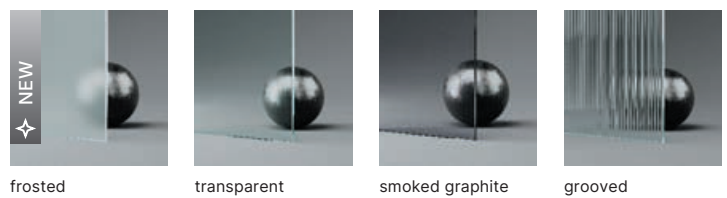

Finishes

See larger visualisations [➤ 252](#)



Additionally

changing the glass panel to smoked graphite, or grooved

# PORTA LUMIA

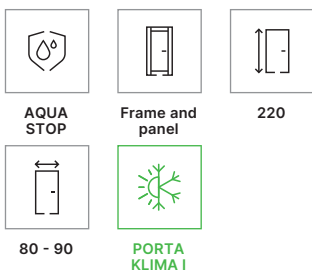

## Recommended door frames

### Non-rebated door frames:

- PORTA SYSTEM ELEGANCE
- PORTA SYSTEM ELEGANCE 90°



Non-rebated

## Notes

- PN EN 14351-2 standard.
- Minimum distance between drills for the door pull: 18 mm from the glass pane.
- The lower surface of stiles are protected against humidity thanks to TechnoPORTA AQUA STOP.

## Accessories

- Two 3D non-rebated hinges.
- Magnetic lock.
- Hardware colours: white, black, silver matte.



PORTA LUMIA 0, Dark Arles Oak, Black door pull

Scan the QR code and learn more about the magnetic lock



## Construction

Rails and stiles are made of glued, laminated softwood, 80mm wide. No possibility of shortening the door leaf. The product is available with a 6 mm thick glass: transparent tempered, frosted laminated safety glass, or for an additional charge, grooved glass. Height '220' - 3 hinges as standard.

This door belongs to design line



## Glass

Check on the website



Estima door pull

magnetic lock

3D hinge



Glazing

See larger visualisations [➤ 203](#)

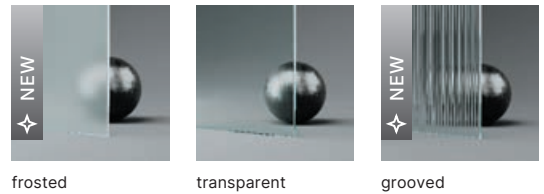

Finishes

See larger visualisations [➤ 252](#)

(2) Uni Colours



(2) Modern



(2) Traditional

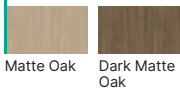

Additionally

- door leaf height '220'

---

- grooved glass

---

- non-rebated: third 3D hinge in silver, black or white (extra charge to the door frame price)

---

- strike plate dedicated to a door frame (extra charge to the door frame price)

---

- ESTIMA door pull (white or black)

# PORTA GLASS



60 - 90

PORTA  
KLIMA I

## Recommended door frames

- PORTA SYSTEM
- STEEL DOOR FRAMES



8 mm

## Notes

- PN EN 14351-2 standard.
- Lock and hinges packed separately.
- The width of the lines in patterns with painted muntins is 30 mm. The muntin is painted on one side on the hinge side (i.e. the door opens to your side).
- Frosted glass is on one side on the hinge side (i.e. the door opens to your side).

## Accessories

- Standard lock (handle only) , bathroom lock or cylinder lock in silver or black colours.
- Two black or silver hinges.

## The final price of PORTA GLASS doors consists of several elements

- Sheet of glass
- DOOR FRAME
- Set of hardware



PORTA GLASS, graphite frosted glass

## Construction

Tempered glass panel of 8 mm thickness with prepared holes for mounting the lock and hinges.

This door belongs to design line



## Glass

Check on the website

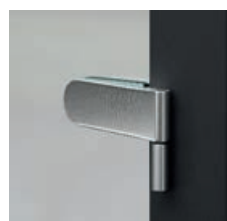

silver hinge



silver lock



grooved glass



graphite frosted glass

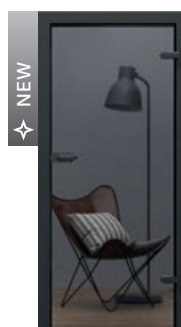

graphite glass



frosted glass panel



transparent glass

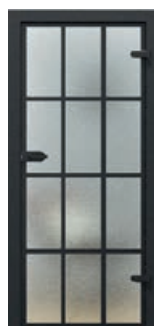

frosted glass with painted muntins

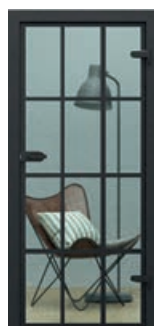

transparent glass with painted muntins



frosted glass with painted muntins, model 2

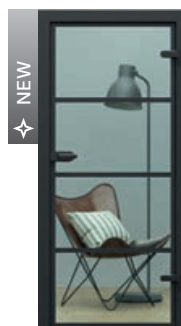

transparent glass with painted muntins, model 2

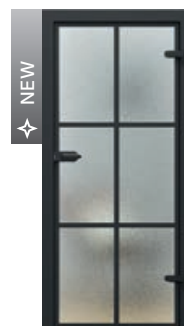

frosted glass with painted muntins, model 3

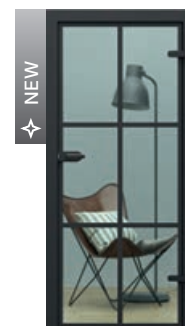

transparent glass with painted muntins, model 3

---

### Additionally

size '90'

K ventilation undercut

# Folding doors and sliding systems

There are two types of sliding systems:



## Pocket system

Door retracts into the wall

Systems: COMPACT  
FRAMELESS

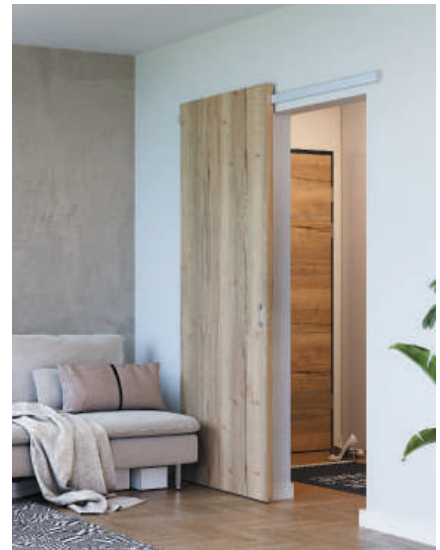

## On-wall system

The door slides along the wall

Systems: PORTA  
BLACK  
SLIDE  
EFEKT

## Discover the advantages of folding doors and sliding doors

- 1** Sliding systems are compatible with all door leaves from PORTA collections.
- 2** They can be installed, for example, between the kitchen and living room, thus **integrating both rooms or dividing them**, depending on your needs.
- 3** They take up less space / **you will save space**.
- 4** They **allow more freedom** in terms of arranging furniture, tall plants in pots or other decorative elements.

## Tip

**BUY CONVENIENTLY AS A SET**  
system + door leaf + door pull  
Check on page [190](#)



FRAMELESS sliding system

Detailed offer is also available on [www.portadoors.com](http://www.portadoors.com)

# How to choose sliding doors?

## Possible modifications

- 1 The use of a soft closer – it is a mechanism for silent and gentle closing of the door leaf.
- 2 Choosing a double leaf door with additional synchronized closing system which allows both doors to be moved simultaneously when opening or closing.
- 3 Use of spacers – in chosen wall systems, it is possible to order spacers that allow the door leaf to be moved away from the wall so that it can slide freely along the wall system. This solution is useful when using skirting boards.
- 4 PORTA sliding system without a tunnel – bespoke option; when ordering this system without a tunnel, the entire product (system + sliding door) is modified.
- 5 Door with a mirror – makes the space look bigger and brightens up the interior.



PORTA sliding system with bespoke finish (contract order).

## On-wall system

### WITH TUNNEL

Option with visible architraves around the door opening (PORTA system).



### WITHOUT TUNNEL

Option without architraves consists of a door leaf, upper track or upper system (SYSTEM BLACK, SLIDE, EFEKT).



## Pocket system

### WITH TUNNEL CONSTRUCTION

Option with visible architraves around the door opening (COMPACT system).



### WITHOUT TUNNEL CONSTRUCTION

For concealed option only the door leaf is visible in the entire construction (FRAMELESS system).



## What to consider when designing?

- 1 Make sure that the wall on which you are planning to install the sliding door does not have any light switches or sockets. When the door is opened, it may obscure the designed installations.
- 2 Choose the type of sliding system at the design stage – a pocket sliding system requires the installation and reinforcement of a wall to house the metal cassette (pocket).
- 3 Check the mounting holes – they will vary depending on the sliding system you choose.
- 4 The installation of sliding doors is possible after the door opening has been properly prepared (straight wall and level floor).
- 5 For sliding systems, choose a dedicated sliding door leaf. All our interior sliding door leaves are compatible with PORTA and COMPACT systems. If you want to use other door leaves in other systems, they will require additional modifications.

The choice of sliding system depends on the goal you want to achieve in your interior design.

#### MINIMALIST EFFECT

We recommend choosing a system without tunnel construction.

#### DOORS WITH CHARACTER

However, if you want to emphasize the character of the interior, choose a system with distinct accents, such as the BLACK wall-mounted system.



**NOTE:** it is not possible to make a ventilation undercut in sliding doors.

# ALFA, BETA folding doors



60 - 100  
(ALFA)



60 - 90  
(BETA)



Sliding  
door leaf

## Door frames

- Modified PORTA SYSTEM frame, width range from B to K.



Rebated  
(ALFA)



Non-rebated  
(BETA)

## The set consists of:

- Track system (extra charge to the set).
- Two-part door leaf.
- PORTA SYSTEM door frame (modified).

## Notes

- National Technical Assessment ITB-KOT-2017/0184 issue 2.

## Accessories

- Seal.
- Three silver concealed hinges.

### ALFA:

- Lock: key lock, WC lock, cylinder lock.
- Strike plate.

### BETA:

- Track.
- Round pull.



ALFA, BETA, White

## Details

Honeycomb core or hollow chipboard core reinforced with plywood rails and stiles (at extra charge).

**Alfa** – a two-part door, unsymmetrically divided, with a standard lock in a door leaf and a tongue strike in a door frame.

**Beta** – a two part door, symmetrically divided without a lock.

## Rebated door leaf



## Non-rebated door leaf

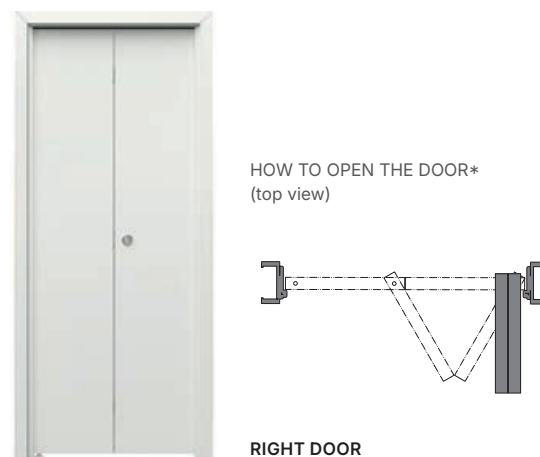

\*NOTE: The design of the fittings causes the clear opening to be narrowed (approximately 10 cm) when the doors are fully opened.

### Dimension table

Door frame type	Size	S <sub>s</sub>	H <sub>s</sub>	D <sub>s</sub>	S <sub>o</sub>	H <sub>o</sub>	O <sub>s</sub>	O <sub>w</sub>	S <sub>b</sub>	H <sub>b</sub>	S <sub>z</sub> (6)	s <sub>z</sub> (8)	H <sub>z</sub>	T <sub>s/w</sub>	
ALFA system	60	644	2000	40	680	2060			646	2043	746	786	2088 / 2108	+20 / +10	
	70	744			780				560		746	846			886
	80	844			880				660		846	946			986
	90	944			980				760		946	1046			1086
	100	1044			1080				860		1046	1146			1186
BETA System	60	588	1990	40	680	2070		2016	646	2050	746	786	2088 / 2108	+20 / +10	
	70	688			780				746		846	886			
	80	788			880				846		946	986			
	90	888			980				946		1046	1086			

### Key to dimensions

S<sub>s</sub> total width of the door leaf (including the rebates)

H<sub>s</sub> total height of the door leaf (including the rebate)

D<sub>s</sub> door leaf thickness

S<sub>o</sub> width of the wall opening prepared for embedding the frame

H<sub>o</sub> height of the wall opening prepared for embedding the frame, measured from the level of the finished floor

O<sub>s</sub> opening width (the dimension is decreased by the door leaf thickness)

O<sub>w</sub> height of the opening after door installation (measured from finished floor level)

S<sub>b</sub> door frame width without architraves

H<sub>b</sub> door frame height, dimension without architraves

S<sub>z</sub> total door frame width with architraves

H<sub>z</sub> total height of door frame, including architraves

T<sub>s/w</sub> permissible tolerance of deviation in width | height of wall opening

Refer to architrave 60/80 mm in dimension tables (S<sub>z</sub>).

### Finish is matched to the finish of the sliding door leaf

See all available finishes [➤ 252](#)

(1) Paint	(1) Synthetic Veneer	(2) Synthetic Veneer/ Soft CPL	(3) CPL laminate
-----------	----------------------	-----------------------------------	------------------

### Additionally

ALFA track (extra charge for the set)

size '100' (ALFA)

hollow chipboard core

ventilation undercut

CPL 0,2 laminates - marked colours\*

CPL 0,2 laminates - UNI MATT GROUP

The price of the PORTA SYSTEM door frame for single-leaf doors in the appropriate adjustment range must be added to the price of the complete set, see [➤ 214](#).

# PORTA sliding system

## Door frames

- PORTA SYSTEM door frame in the 'tunnel' version.

## The set consists of:

- On-wall mounted sliding system (track).
- A door leaf (sliding version).
- A door frame\* ('tunnel' version).

\* not included in the price

## Notes

- National Technical Assessment ITB-KOT-2017/0184 issue 2.
- Set is reversible (left/right). Opening direction can be changed by installing door stop (jamb) on right or left side of PORTA System tunnel.

## Accessories included in the price

- A rail with trolleys.
- Strike plate.
- Self-adhesive brush seal.
- Floor mounted, door leaf guiding and stabilizing element.



## Construction

On Wall Sliding system consists of: a rail bar with trolleys, rail cover & door stop. Rail cover and a door stop are made of chipboard and MDF. All sliding version door leaves is compatible with System PORTA.

## PORTA sliding system

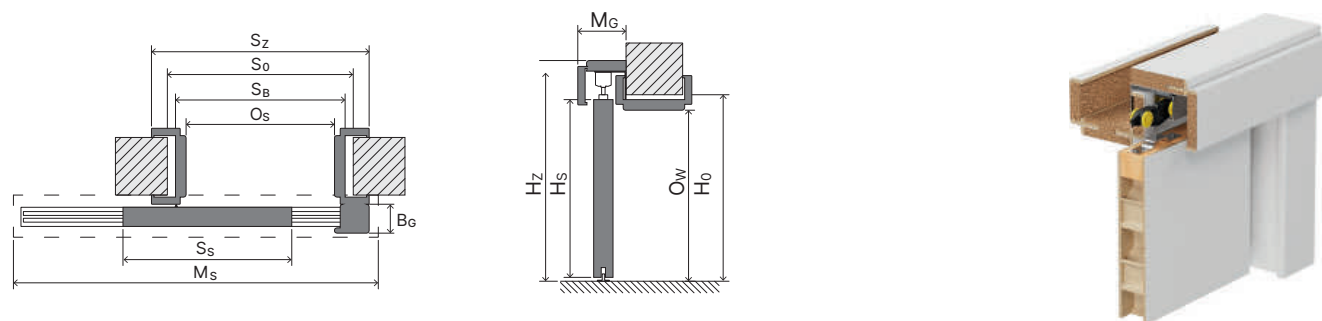

### Dimension table

	Size	S <sub>s</sub>	H <sub>s</sub>	D <sub>s</sub>	S <sub>o</sub> (6)/(8)	H <sub>o</sub>	O <sub>s</sub> (6)/(8)	O <sub>w</sub>	H <sub>z</sub>	M <sub>s</sub> (6)/(8)	M <sub>G</sub>	B <sub>G</sub>	T <sub>s/w</sub>
PORTA sliding system	60	644	2030	40	680 / -	2060	602 / -	2016	2119	1413	103	60	+20 / +10
	70	744			780 / -		702 / -			1613			
	80	844			880 / -		802 / -			1813			
	90	944			980 / -		902 / -			2013			
	100	1044			1080 / -		1002 / -			2213			

### Key to dimensions

S<sub>s</sub> total width of the door leaf (including the rebates)

H<sub>s</sub> total height of the door leaf (including the rebate)

D<sub>s</sub> door leaf thickness

S<sub>o</sub> width of the wall opening prepared for embedding the frame

H<sub>o</sub> height of the wall opening prepared for embedding the frame, measured from the level of the finished floor

O<sub>s</sub> opening width

O<sub>w</sub> height of the opening after door installation (measured from finished floor level)

H<sub>z</sub> total height of door frame, including architraves

M<sub>s</sub> width of sliding door masking system

M<sub>G</sub> thickness of a rail cover (sliding systems)

B<sub>G</sub> thickness of a door stop (jamb) (sliding systems)

T<sub>s/w</sub> permissible tolerance of deviation in width | height of wall opening

Refer to architrave 60/80 mm in dimension tables (S<sub>o</sub>, O<sub>s</sub>, M<sub>s</sub>).

### Finish is matched to the finish of the sliding door leaf

See all available finishes [➤ 252](#)

### Additionally

CPL 0,2 laminates - marked colours\*

CPL 0,2 laminates - UNI MATT GROUP

finishing with natural veneer: White Oak, Satin

finishing with natural veneer: Select Black

- (1) Synthetic veneer
- (2) Synthetic veneer/Soft CPL
- (1) CPL laminate
- Premium Lacquered Veneer
- Natural veneers Select and natural Oak
- Natural Satin veneers

# COMPACT sliding system

## Door frames

- Door frames - 'tunnel' option. Available for wall thicknesses: 100 mm, 125 mm and 150 mm.
- 'Tunnel' door frame dedicated for a wall thickness 125 mm is compatible with the PORTA pocket.
- All of the above tunnels are compatible with metal cassettes (pockets) from leading European producers (check  $S_o/H_o$  dimensions).

## Notes

- Pocket system is dedicated for 125 mm thick plasterboard walls.
- National Technical Assessment ITB-KOT-2017/0184 issue 2.
- It is possible to order additional extensions for symmetrical and unsymmetrical 'tunnel frames' (bespoke order).
- Tunnel 100 mm is available with door leaves without glazing beads/decorative mouldings.

## Accessories included in the price

- Metal cassette (pocket) is dedicated to 125 mm thick walls.
- A rail with trolleys and door leaf guiding element, mounted to the floor.
- Hook lock strike plate (optionally at extra charge).
- Anti-dust brush seal, pressed in (tunnels dedicated for a wall 125 mm and 150 mm thick).
- Tunnel dedicated to 125 mm thick walls.



COMPACT sliding system, PORTA CONCEPT A.9, Natural Arles Oak

## Details

Offered system for a 125 mm thick wall, consists of: a 'tunnel frame' made of chipboard and MDF; galvanized steel cassette with a running track, which are a pocket construction inside the wall.

## How to open the door

NOTE! Porta Compact tunnel frame is compatible with Porta pockets and pockets of leading European producers. Before installing Compact tunnel frame along with a pocket not produced by PORTA, it is required to check  $S_o/H_o$  dimensions.

top view

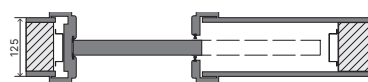

POCKET DOOR SYSTEM COMPACT ('TUNNEL' FRAME, METAL CASSETTE 'POCKET' DEDICATED FOR A WALL 125 MM THICK)

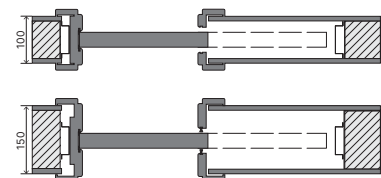

COMPACT 'TUNNEL' FRAMES ARE DEDICATED FOR WALL THICKNESSES 100 MM AND 150 MM

## COMPACT sliding system

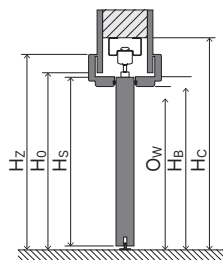
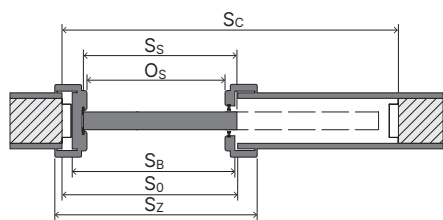

hook lock



Metal cassette (pocket)

### Dimension table

	Size	S <sub>s</sub>	H <sub>s</sub>	S <sub>o</sub>	H <sub>o</sub>	O <sub>s</sub>	O <sub>w</sub>	S <sub>b</sub>	H <sub>b</sub>	S <sub>z</sub> (6)	S <sub>z</sub> (8)	H <sub>z</sub> (6)/(8)	S <sub>c</sub>	H <sub>c</sub>	T <sub>sw</sub>
COMPACT sliding system - single	60	644	2030	660	2065	600	2018	654	2040	744	784	2090 / 2110	1355	2130	+5 / +10
	70	744		760		700		754		844	884		1555		
	80	844		860		800		854		944	984		1755		
	90	944		960		900		954		1044	1084		1955		
	100	1044		1060		1000		1054		1144	1184		2155		
COMPACT sliding system - double	2 × 60	644	2030	1265	2065	1214	2018	1258	2040	1358	1398	2090 / 2110	2610	2130	+5 / +10
	2 × 70	744		1465		1414		1458		1558	1598		3010		
	2 × 80	844		1665		1614		1658		1758	1798		3410		
	2 × 90	944		1865		1814		1858		1958	1998		3810		
	2 × 100	1044		2065		2014		2058		2158	2198		4210		

### Key to dimensions

- S<sub>s</sub> total width of the door leaf (including the rebates)
- H<sub>s</sub> total height of the door leaf (including the rebate)
- S<sub>o</sub> opening width in the metal cassette (pocket) for installing wood grain door frame
- H<sub>o</sub> opening height in the metal cassette (pocket) for installing wood grain door frame
- O<sub>s</sub> opening width
- O<sub>w</sub> height of the opening after door installation (measured from finished floor level)
- S<sub>b</sub> door frame width without architraves

- H<sub>b</sub> door frame height, dimension without architraves
  - S<sub>z</sub> total door frame width with architraves
  - H<sub>z</sub> total height of door frame, including architraves
  - S<sub>c</sub> wall opening width for a metal cassette (pocket door system)
  - H<sub>c</sub> wall opening height for a metal cassette (pocket door system), (measured from finished floor level)
  - T<sub>sw</sub> permissible tolerance of deviation in width | height of wall opening
- Refer to architrave 60/80 mm in dimension tables (S<sub>z</sub>, H<sub>z</sub>).

### Finishes matched to the finish of the sliding door leaf

See all available finishes ➔ 252

Single-leaf COMPACT system	(1) Synthetic Veneer	(2) Synthetic Veneer/Soft CPL	(3) CPL laminate	(2) Premium Lacquered Veneer	(3) Premium Plus UV Paint
-------------------------------	-------------------------	----------------------------------	------------------	---------------------------------	------------------------------



**PORTA CONTRACT**  
Option to order the tunnel finished with natural veneer.

### Additionally

CPL 0,2 laminates - marked colours\*

CPL 0,2 laminates - UNI MATT GROUP

closing synchronization system - double doors

# FRAMELESS sliding system

## Framless system construction

- The sliding system is made of aluminium profiles adapted for installation in plasterboard or solid brick walls. Can be used with 40 mm thick door leaves.
- The system is equipped with a full set of accessories and functions allowing precise installation and adjustment of the door leaf (adjustment of the depth of the leaf's recess in the system, adjustment of the leaf's position relative to the frame 1-2 at a height of +/- 2.5 mm), as well as a removable stop beam enabling the replacement of the door leaf, a set of seals, guides, and bearing rollers.

## Notes

- PN EN 14351-2 standard – door leaf.
- National Technical Assessment ITB-KOT-2020/1281 issue.1 - sliding system.
- System prepared for plasterboard walls with a thickness of 100 mm or 125 mm.

## Accessories included in the price

- Metal cassette (pocket).
- Hook lock strike plate (optionally at extra charge).



FRAMELESS sliding system, Premium paint

## Details

Plasterboard or hollow chipboard core (optionally at extra charge). The construction is skinned with HDF.



door leaf with hook lock



dedicated pull handles (round or square)

## FRAMELESS sliding system

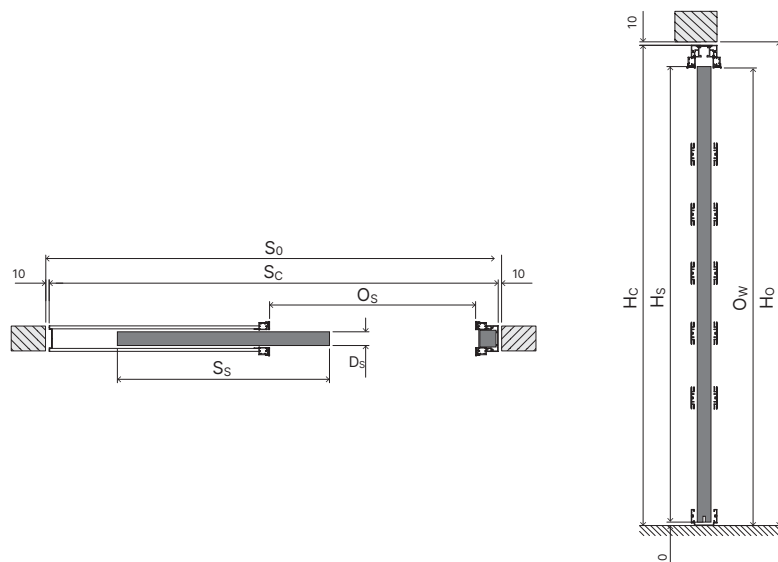

### How to open the door

The system does not require a door frame and architraves. The cassette (pocket) is dedicated to be installed in plasterboard walls.

top view



SLIDING SYSTEM DEDICATED FOR A WALL 100 MM THICK.



SLIDING SYSTEM DEDICATED FOR A WALL 125 MM THICK.

### Dimension table

	Size	$S_s$	$H_s$	$D_s$	$S_o$	$H_o$	$O_s$	$O_w$	$S_c$	$H_c$	$T_{s/w}$
Frameless system	70	744	2030	40	1580	2110	726	2036	1560	2102	+10 / +10
	80	844			1780		826		1760		
	90	944			1980		926		1960		

### Key to dimensions

$S_s$  total width of the door leaf (including the rebates)

$H_s$  total height of the door leaf (including the rebate)

$D_s$  door leaf thickness

$S_o$  width of the wall opening prepared for embedding the frame

$H_o$  height of the wall opening prepared for embedding the frame, measured from the level of the finished floor

$O_s$  opening width

$O_w$  height of the opening after door installation (measured from finished floor level)

$S_c$  wall opening width for a metal cassette (pocket door system)

$H_c$  wall opening height for a metal cassette (pocket door system), (measured from finished floor level)

$T_{s/w}$  permissible tolerance of deviation in width | height of wall opening

Available finishes the same as for PORTA HIDE ➔ 80

See larger visualisations ➔ 252

(1) Prime paint

(2) Premium UV Paint

(3) Premium Plus UV Paint

(2) Synthetic Veneer

Natural Veneer Select matte

Natural Veneer

### Additionally

hollow chipboard core

hook lock with door pulls

round or square door pull

finishing with natural veneer: Matt Oak

finishing with natural veneer: matte: Oak, Bianco Oak, Taupe Walnut

finishing with natural veneer: White Oak Satin, natural Select Black

# BLACK sliding system

## Notes

- PN EN 14351-2 standard.
- Set is reversible (left/right).
- Set is dedicated to be mounted on wall opening one size smaller than standard.
- Hook lock is not available.
- For a double door leaf set the following parts must be ordered: two sliding systems, two door leaves and a bracket.

In case of using spacers there is a possibility to move the door leaf away from the wall - 10 mm. Possibility of having BLACK system with other sliding door leaf from PORTA's offer.

- Black system, type LUNA can be ordered with any door leaf in sliding version.
- Black system, type REA is intended for use exclusively with frame and panel door leaves and flush door leaves with hollow chipboard core.

## Accessories included in the price

- Track 2000 mm.



## Construction

Plasterboard or hollow chipboard core (optionally at extra charge).  
The construction is skinned with HDF.



REA type



LUNA type



wall-mounted guide rail



pull Black 1



### Dimension table

	Size	S <sub>s</sub>	H <sub>s</sub>	D <sub>s</sub>	S <sub>o</sub>	H <sub>o</sub>	M <sub>s</sub>	T <sub>s/w</sub>
BLACK sliding system	70	744	2090	40	680	2060	2000	±10 / ±5
	80	844			780			
	90	944			880			
	100	1044			980			

\* In case of installing different door leaf than PORTA BLACK, wall opening should be decreased by 60 mm.

	Size	S <sub>s1</sub>	S <sub>s2</sub>	H <sub>s</sub>	D <sub>s</sub>	S <sub>o</sub>	H <sub>o</sub>	M <sub>s</sub>	T <sub>s/w</sub>
BLACK double sliding system	70 + 70	744	744	2090	40	1425	2060	4000	±10 / ±5
	80 + 70	844	744			1525			
	80 + 80	844	844			1625			
	90 + 70	944	744			1625			
	90 + 80	944	844			1725			
	90 + 90	944	944			1825			
	100 + 70	1044	744			1725			
	100 + 80	1044	844			1825			
	100 + 90	1044	944			1925			
	100 + 100	1044	1044			2025			

### Key to dimensions

S<sub>s</sub> total width of the door leaf (including the rebates)

H<sub>s</sub> total height of the door leaf (including the rebate)

D<sub>s</sub> door leaf thickness

S<sub>o</sub> width of the wall opening prepared for embedding the frame

H<sub>o</sub> height of the wall opening prepared for embedding the frame, measured from the level of the finished floor

M<sub>s</sub> width of sliding door masking system

T<sub>s/w</sub> permissible tolerance of deviation in width | height of wall opening

### Finishes matched to the finish of the sliding door leaf

See larger visualisations [↗](#) 252

Premium UV Paint	Premium Plus UV Paint
	
White	White

### Additionally

hollow chipboard core

Black door pull for one side

an oblong pull for sliding door

bracket for double door solutions

set of two soft-closers

set of 5 spacers

guiding rail for door leaf mounted to the wall

# SLIDE sliding system

## Notes

- PN EN 14351-2 standard.
- Set is dedicated to be mounted on wall opening one size smaller than standard.
- Hook lock is not available.

## Accessories included in the price

- Track 2000 mm.
- Set of two Soft-Closers with Anti-Slam.



## Details

Hollow chipboard core. The construction is skinned with HDF.

## Door opening directions

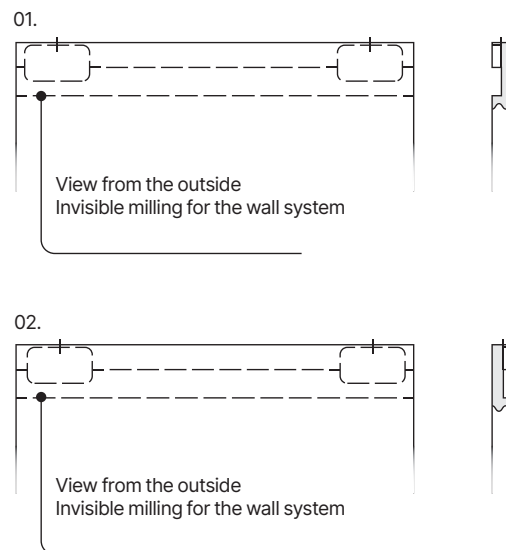
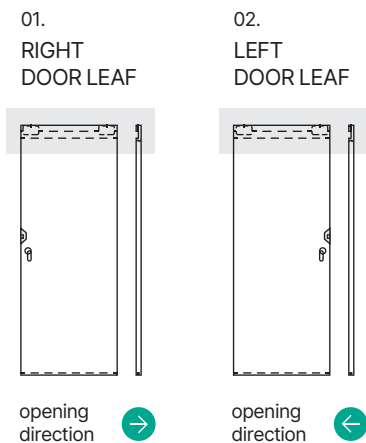

### Dimension table

	Size	S <sub>s</sub>	H <sub>s</sub>	D <sub>s</sub>	S <sub>o</sub>	H <sub>o</sub>	M <sub>s</sub>	T <sub>s/w</sub>
SLIDE sliding system	70	744	2200	40	680	2060	2010	±10 / ±5
	80	844			780			
	90	944			880			
	100	1044			980			

### Key to dimensions

S<sub>s</sub> total width of the door leaf (including the rebates)

H<sub>s</sub> total height of the door leaf (including the rebate)

D<sub>s</sub> door leaf thickness

S<sub>o</sub> width of the wall opening prepared for embedding the frame

H<sub>o</sub> height of the wall opening prepared for embedding the frame, measured from the level of the finished floor

M<sub>s</sub> width of sliding door masking system

T<sub>s/w</sub> permissible tolerance of deviation in width | height of wall opening

### Finishes matched to the finish of the sliding door leaf

See larger visualisations → 252

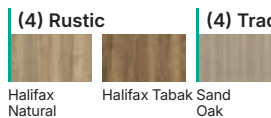
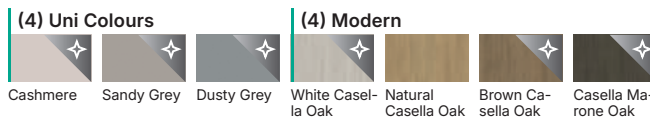
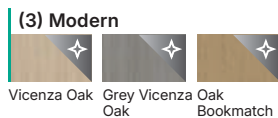

**PLEASE NOTE!** The number in brackets, e.g. (1) is the finish group  
Check the back cover flap

### Additionally

an oblong pull for sliding door

# EFEKT sliding system

## Notes

- PN EN 14351-2 standard.
- Hook lock is not available.
- Load capacity of the system: 80 kg.
- The gap between door leaf and a wall: 10 mm. During installation, this dimension can be increased by using a spacer for top trolley (spacer is not a part of the set). The second option is to order a door leaf fitted to needed gap size (Contract Department).
- The set is dedicated to be mounted on wall opening three sizes smaller than standard → e.g. wall opening '60' requires door leaf '90'.

## Accessories included in the price

- Tracks.



## Details

Hollow chipboard core. The construction is skinned with HDF.

## Door opening directions

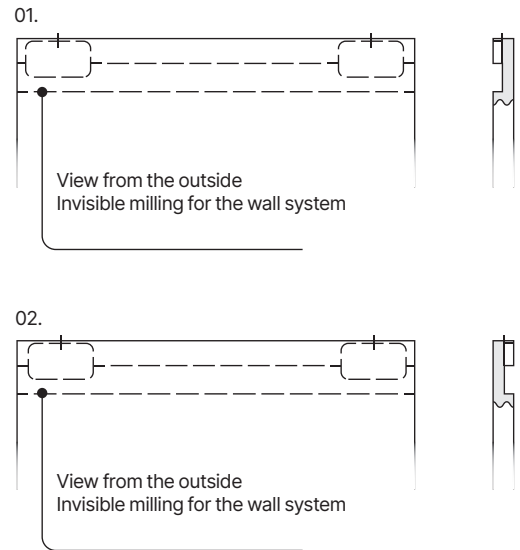
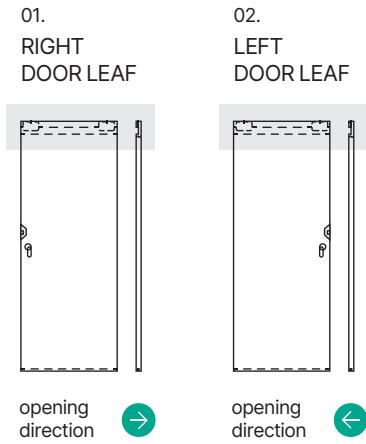

### Dimension table

	Size	S <sub>s</sub>	H <sub>s</sub>	D <sub>s</sub>	S <sub>o</sub>	H <sub>o</sub>	M <sub>s</sub>	T <sub>sw</sub>
EFEKT sliding system	90	944	2230	40	680	2060	1665	±10 / ±5
	100	1044			780		1865	
	110	1144			880		2065	

### Key to dimensions

- S<sub>s</sub> total width of the door leaf (including the rebates)
- H<sub>s</sub> total height of the door leaf (including the rebate)
- D<sub>s</sub> door leaf thickness
- S<sub>o</sub> width of the wall opening prepared for embedding the frame
- H<sub>o</sub> height of the wall opening prepared for embedding the frame, measured from the level of the finished floor
- M<sub>s</sub> width of sliding door masking system
- T<sub>sw</sub> permissible tolerance of deviation in width | height of wall opening

### Finishes matched to the finish of the sliding door leaf

See larger visualisations → 252

#### Premium Paint



White

#### (2) Uni Colours



White    Cashmere    Grey    Fjord    Olive

#### (3) Modern



Vicenza Oak    Grey Vicenza Oak    Bookmatch

#### (4) Uni Colours



Cashmere    Sandy Grey    Dusty Grey

#### (4) Modern



White Casella Oak    Natural Casella Oak    Brown Casella Oak    Casella Marone Oak

#### (4) Rustic



Halifax Natural    Halifax Tabak

#### (4) Traditional



Sand Oak

**PLEASE NOTE!** The number in brackets, e.g. (1) is the finish group  
Check the back cover flap

### Additionally

size '100'

size '110'

an oblong pull for sliding door

# Technical information and accessories for sliding doors

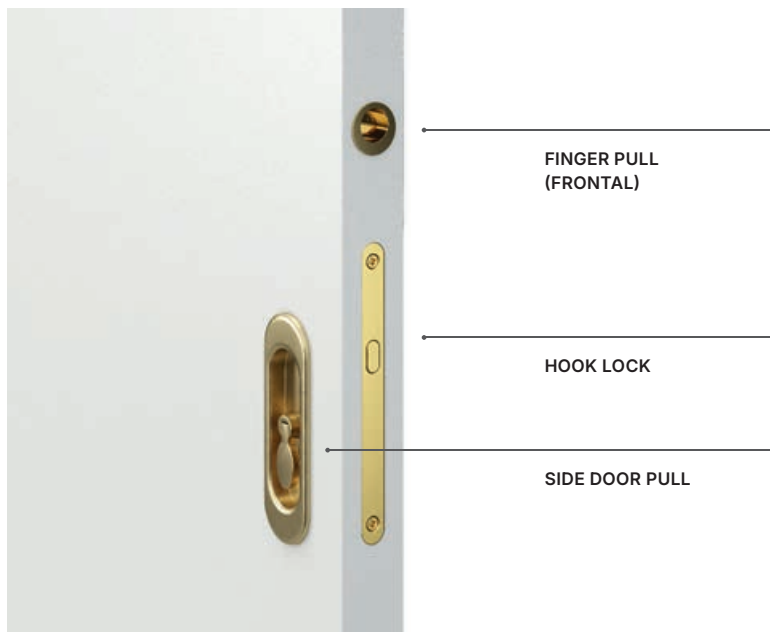

**HOOK LOCK WITH KEY OR BATHROOM LOCK WITH SIDE AND FRONT DOOR PULLS, FOR SLIDING DOORS**

Gold, matte gold, silver, matte silver, black

## Available shapes and colours of side door pulls

### Longitudinal door pulls



**LONGITUDINAL DOOR PULLS FOR SLIDING DOORS**

Silver, matte silver, gold, matte gold, black.

### Rectangular door pulls



**RECTANGULAR AND OBLONG DOOR PULLS (SET) FOR SLIDING DOOR**

Gold, matte gold, silver, matte silver, black



### Round door pull

**ROUND DOOR PULL FOR SLIDING DOORS**

Silver, gold, black

# Sliding door

Sliding doors are produced as left-hand sliding doors.

## Pocket system - double

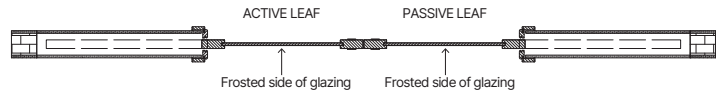

## Pocket system - single

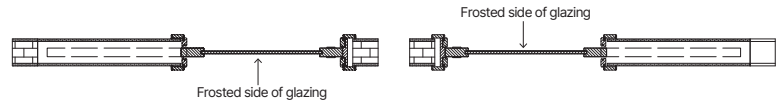

## On-wall system

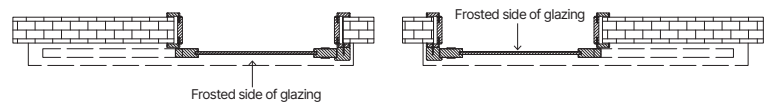

# Mirror in sliding doors

## For marking the wider side of the leaf

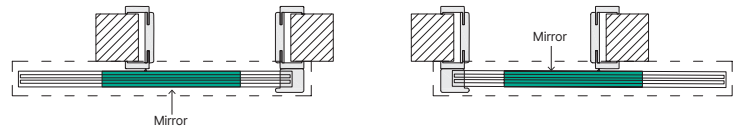

## To mark the narrower side of the leaf

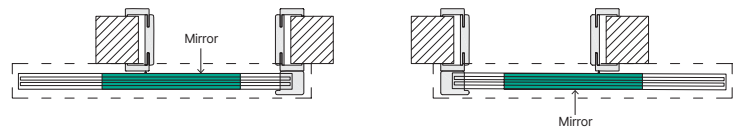

## Single

## For marking the wider side of the leaf

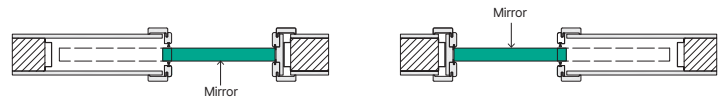

## To mark the narrower side of the leaf

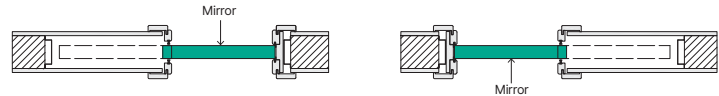

## Compact

## For marking the wider side of the leaf



## To mark the narrower side of the leaf

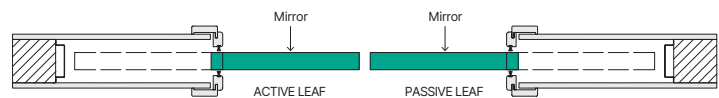

## Double

# Economical and popular models



Escutcheon  
10 mm



GREAT  
PRICE

PORTA VERTE HOME L.4, Matte Oak, Euphoria handle, Silver

# Basic

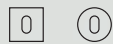

key lock escutcheon

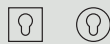

cylinder lock escutcheon



WC escutcheon

A. Euphoria  
B. Doro  
C. Segura

black, silver

Due to printing technology, the colour of presented products in the catalogue may slightly differ from the actual product.

A wide selection of  
fashionable shapes and  
colours



Escutcheon  
6 mm



Durability



Many  
colours

"PORTA HIDE 1.1, 'Primer with applied colour coat NCS S 6010-G10Y, Fiore handle, Gunmetal'.

# Trend



key lock escutcheon



cylinder lock escutcheon



WC escutcheon

	key lock escutcheon	cylinder lock escutcheon	WC escutcheon
A. Smplo		black, white, silver matte	
B. Fiumo		black, silver matte, golden matte	
C. Eleganto		black, white, silver matte, golden matte	
D. Fioro		black, white, silver, gold, golden matte, gunmetal	
E. Lago		black, silver, gold, golden matte, gunmetal	

Due to printing technology, the colour of presented products in the catalogue may slightly differ from the actual product.

# Colour combination

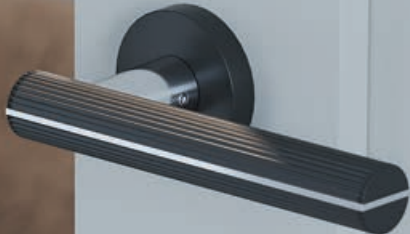

Stylish handle



Durability

PORTA GRANDE A.0, Gray, Calio handle, Black with silver

# Prestige

[PORTA] NEW LINE



key lock escutcheon



cylinder lock escutcheon

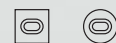

WC escutcheon

A. Calio

B. Fresco

C. Plato

D. Supro

black with gold PVD, black with silver

Due to printing technology, the colour of presented products in the catalogue may slightly differ from the actual product.

# Timeless and elegant details









Stylish handle



Durability

# CLASSIC



	  key lock escutcheon	  cylinder lock escutcheon	   WC escutcheon
A. Caldo		gold PVD, black, silver	
B. Nobile		gold PVD, black, silver	
C. Modern		black, white	
	key option	cylinder option	WC option
D. Lungo			

Due to printing technology, the colour of presented products in the catalogue may slightly differ from the actual product.

Many possibilities in original forms



Stylish handle



Durability

WATER W.2, Premium Plus White UV Paint, MAGRO handle, Black

# Geometry

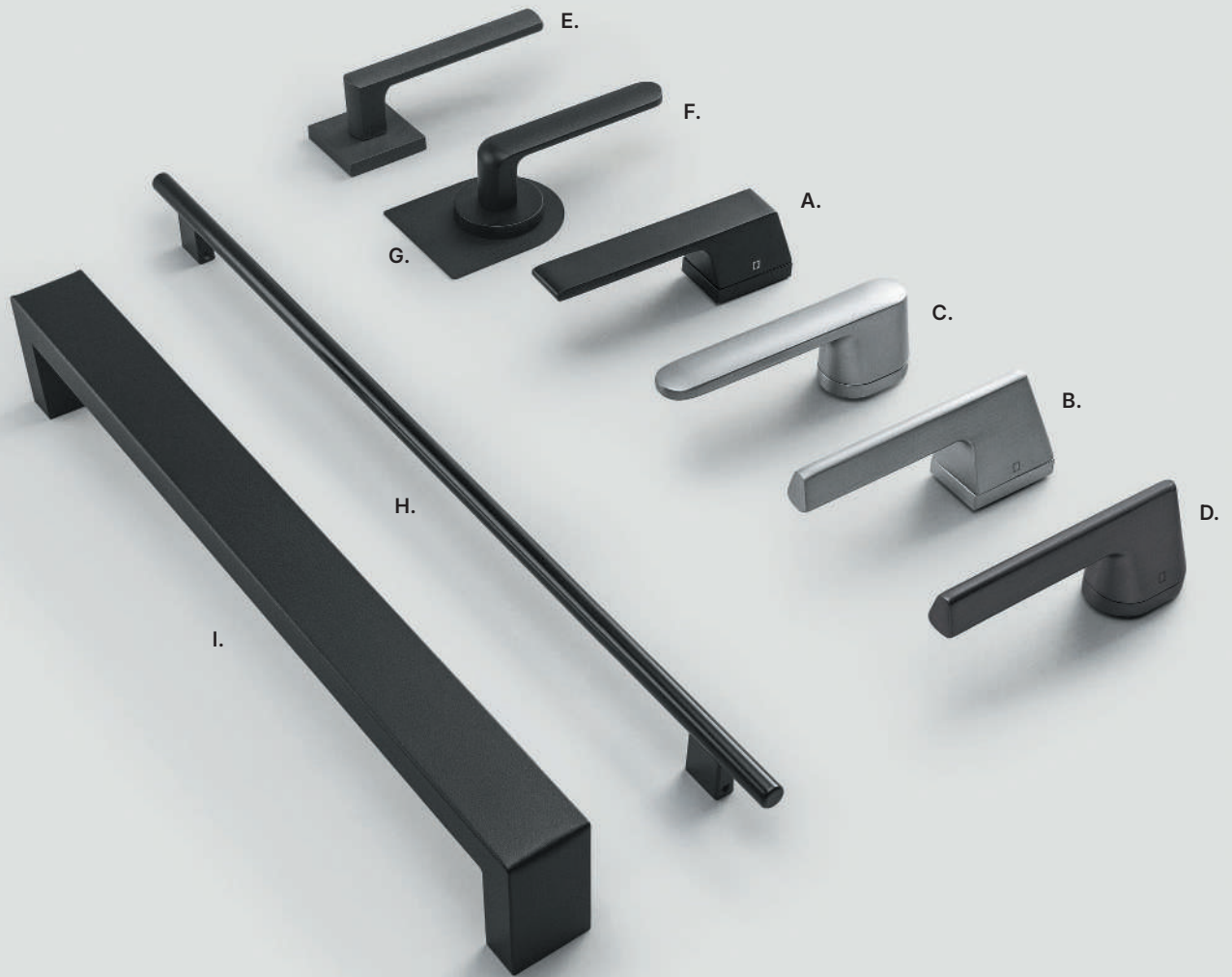

key lock escutcheon



cylinder lock escutcheon



WC escutcheon

A. Magro  
B. Magro Slim  
C. Finaro  
D. Finaro Slim

silver matte, gunmetal, black



E. UNICO  
F. ORGANIC

structured black, structured anthracite

G. Door handle pad

structured black, structured anthracite

H. Estima door pull (56 cm)

black, white

H. Estima door pull (56 cm)

structured black

Washer shapes (G.)



rectangular



round



oval



# Set of accessories for doors and furniture



PORTA GRANDE A.1 grooved glass pane , Cashmere, Azura door handle , Gold; furniture handle 320 mm

# Azura



	 key lock escutcheon	 cylinder lock escutcheon	 WC escutcheon
A. Azura		golden, black, silver	

Accessories	door stop	B. wall-mounted floor-mounted	black, white, golden
	hanger	D.	
furniture handle	E.* 320 mm		
	F.* 192 mm		
	G.* 128 mm		
	H. t-bar		
furniture knob	I. con		
	J. roller		

Due to printing technology, the colour of presented products in the catalogue may slightly differ from the actual product.  
 \* The measurements specified for longitudinal furniture handles (320 mm, 192 mm, 128 mm) indicate the spacing between the centers of the mounting screws.

# Additional accessories

## Door handle washers



ROUND PLATE



RECTANGULAR PLATE



OVAL PLATE

## Magnetic stopper



Easy and quick installation using strong mounting tape without the need to make holes in the floor!

Concealed door locking system, taking up minimal floor space. Suitable for solutions without a drop seal and recuperation shortcut. Requires preparing a hole in the door leaf.

NEW



## Cylinder



CYLINDER FOR INTERIOR DOOR

Size:

- 30/30 non-rebated door
- 26/35 rebated door

Black

Silver

## Types of glazing



TRANSPARENT GLASS PANEL



BLACK GLASS PANEL

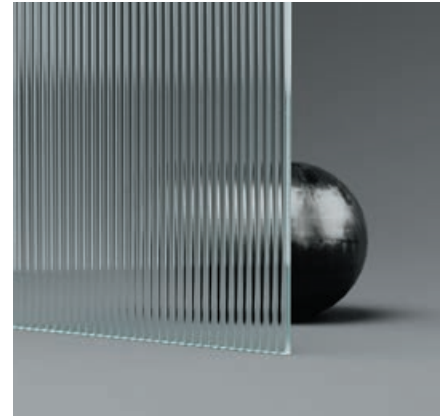

GROOVED GLASS PANEL



FROSTED GLASS PANEL 'FRAME'

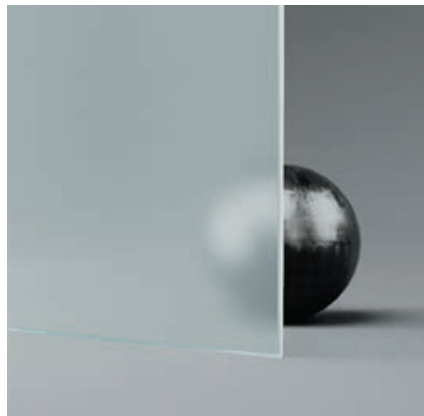

FROSTED GLASS PANEL

## STAINLESS STEEL PORTHOLE

The outer diameter is 350 mm. Available glass panels: transparent or laminated frosted glass panel class 2, 6 mm thick.

Porthole is only available for door leaves with hollow chipboard core, in the following flush door models:

- PORTA DECOR
- PORTA CPL
- NATURE CLASSIC
- PORTA RESIST



Stainless steel



Black

# Door frames

What to consider when choosing a door frame?

## Choose a function

### Concealed:

#### PORTA HIDE

Design a door according to your own idea! Paint, wallpaper, and decorate however you like.

For more information go to page [80](#)

### Waterproof:

#### HYDRO PROTECT™ STEEL DOOR FRAMES

For more information go to page [207](#)



## Choose type

Non-rebated door frames are designed to conceal the hinges when the door is closed.

It gives the impression that the door leaf is perfectly connected to the door frame and forms a uniform surface with it.

Rebated door frames have a traditional construction.

The rebated door frame connects to the door leaf in such a way that the meeting edge type of the door leaf slightly overlaps the meeting edge type of the door frame.

For more information go to page [208](#)

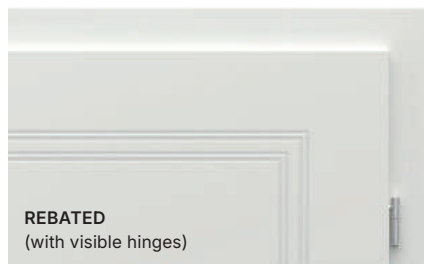
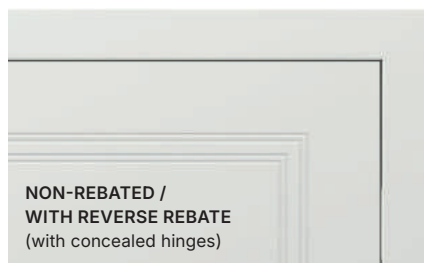

## Choose additional items

Check out how easily you can give your door a new character! Pay attention to the finish details and fashionable accessories that you can buy without having to replace the door.

#### RETRO MODULE

Stylized crown and pilasters for installation with a door frame. More on page [210](#)



#### SKIRTING BOARD

Elegant and practical way to finish your interior. More on page [231](#)





What to consider when choosing a door frame?

## Choose a function

Choose a waterproof door frame that guarantees durability and reliability for many years to come.

---

### Steel door frame with many advantages

Steel door frames are the ideal choice for the most demanding spaces, both in terms of durability and attractiveness. Thanks to their versatility, they can be used in both new and older buildings that require thoughtful renovation, giving them a unique style and design. A wide range of modifications and bespoke options, including any RAL or NCS colour, opens up many possibilities.



#### No visible joints

Steel door frames are welded at the joints and then powder paint coated with Premium Polyester Paint. This makes the corner line invisible and very durable at the same time.



#### High durability

The precision of workmanship and the materials used in production guarantee long-lasting quality. Thanks to their high resistance to mechanical damage and corrosion, they will be a great investment for years to come. They are particularly suitable for use in the bathroom or kitchen, i.e. rooms where humidity is usually high.

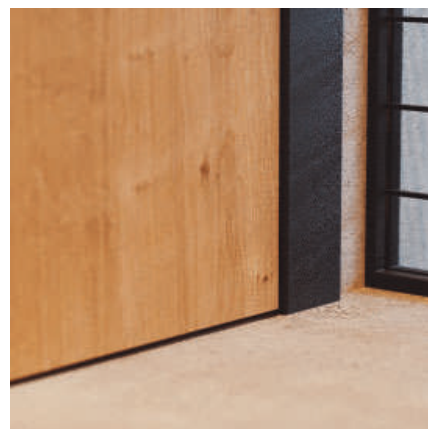

#### Humidity resistant

Steel door frames are made of galvanized steel sheet and additionally protected with a passivation layer during the surface preparation process. Next, a layer of polyester powder paint is applied. All this increases corrosion resistance for many years and protects door frames from water, e.g. when washing floors.

**100%  
WATERPROOF**



**DOOR FRAME  
HYDRO PROTECT™**

**No more swollen  
door frames in wet  
rooms!**

**A new  
dimension of  
durability**

Exceptional moisture humidity  
and warp, ideal for bathrooms,  
kitchens, or laundry rooms.

**Identical look**

The same as other door frames  
from the PORTA SYSTEM and  
PORTA SYSTEM ELEGANCE  
series.

**Available in many  
PORTA door  
collections**

Look for the blue marking  
HYDRO PROTECT™ next to  
products in the catalogue.

**Replace your swollen  
door frame with  
HYDRO PROTECT™  
without renovating  
your bathroom!**

**FUNCTION  
+ DESIGN**

What to consider when choosing a door frame?

## Choose type

Door frames

### non-rebated

- 1 The surface of the door leaf is even with the door frame.
- 2 Concealed hinges.
- 3 A door leaf without a rebate is made without a notch, the so-called rebate.



REBATE AT AN EVEN LEVEL WITH A DOOR FRAME

CONCEALED 3D HINGE



Top view



Non-rebated door frames in the PORTA offer:

PORTA SYSTEM ELEGANCE **HYDRO PROTECT™**  
PORTA SYSTEM ELEGANCE  
PORTA SYSTEM ELEGANCE 90°  
Steel PORTA SYSTEM ELEGANCE  
LEVEL

Door frames

### with upper panel

- 1 The surface of the door leaf is even with the door frame.
- 2 Concealed hinges.
- 3 A door leaf without a rebate is made without a notch, the so-called rebate.
- 4 Upper panel, thanks to which you can optically lengthen the door.



REBATE AT AN EVEN LEVEL WITH A DOOR FRAME

CONCEALED 3D HINGE



#### Tip

THE UPPER PANEL IS AVAILABLE IN TWO HEIGHTS:  
20 cm and 100 cm, with the option of shortening to the desired height.

Top view



Door frames with upper panels in the PORTA offer:

LEVEL

## Door frames with reverse rebate



- 1 The surface of the door leaf is even with the door frame.
- 2 Concealed hinges.
- 3 A door leaf with a reverse rebate opens inwards, while maintaining the aesthetic effect of a flush surface on the outside.

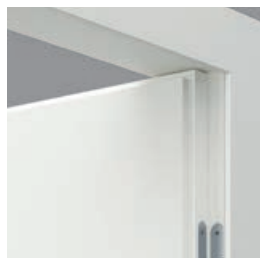

REBATE AT AN EVEN LEVEL  
WITH A DOOR FRAME

CONCEALED 3D HINGE



### Tip

When designing the interior and during the installation, pay attention to **THE LOCATION OF THE FLOOR JOINT** – it should be directly under the door leaf.

Top view



Reverse rebate door frames in the PORTA offer:

PORTA SYSTEM with reverse rebate

Detailed offer is also available on [www.portadoors.com](http://www.portadoors.com)

## Door frames rebated



- 1 The door leaf overlaps the door frame.
- 2 Visible hinges.
- 3 Door leaf with rebate.

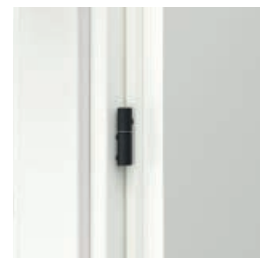

VISIBLE REBATE

VISIBLE BARREL HINGE



Top view



Rebated door frames in the PORTA offer:

PORTA SYSTEM **HYDRO PROTECT™**  
 PORTA SYSTEM  
 PORTA SYSTEM 90°  
 Steel PORTA SYSTEM  
 MINIMAX  
 RENOVA

What to consider when choosing a door frame?

## Choose additional elements

Module

### RETRO

PORTA SYSTEM + RETRO module (crown + set of vertical pilasters)



PORTA INSPIRE

RETRO module for PORTA SYSTEM frame (set for one side)

(1) Synthetic Veneer	(2) Synthetic Veneer/Soft CPL	(3) Premium Plus UV Paint	Natural veneers
----------------------	-------------------------------	---------------------------	-----------------

Decorative trims

### LINEO

The use of the LINEO decorative trim increases the dimension  $S_2$  (total width of the door frame) by 66 mm, and  $H_2$  (total height of the door frame) by 33 mm. The LINEO decorative trim has a total width of 45 mm.

NEW



PORTA GRANDE

LINEO decorative slats

(1) Synthetic Veneer	(2) Synthetic Veneer/Soft CPL	(3) Premium Plus UV Paint
----------------------	-------------------------------	---------------------------

#### Additionally

crowns: natural veneer White Oak, Satin

decorative pilasters: Natural veneer White Oak, Satin

Tip

DECORATIVE TRIMS INCREASE THE TOTAL WIDTH OF THE DOOR. Check the distance from switches and electrical sockets.

Decorative trims  
**IMPERIAL**

NEW

The use of the IMPERIAL decorative trim increases the dimension  $S_2$  (total width of the door frame) by 82 mm, and  $H_2$  (total height of the door frame) by 41 mm. The IMPERIAL decorative trim has a total width of 57 mm.



PORTA IMPERIAL

IMPERIAL decorative slats	(1) Synthetic Veneer	(2) Synthetic Veneer/Soft CPL	(3) Premium Plus UV Paint
---------------------------	----------------------	-------------------------------	---------------------------

Decorative trims  
**ORNATO**

NEW

The use of ORNATO decorative strips trims the  $S_2$  dimension (total width of the door frame) by 82 mm and the  $H_2$  dimension (total height of the door frame) by 41 mm. The ORNATO decorative trim has a total width of 57 mm.



PORTA ORNATO

ORNATO decorative slats	(1) Synthetic Veneer	(2) Synthetic Veneer/Soft CPL	(3) Premium Plus UV Paint
-------------------------	----------------------	-------------------------------	---------------------------



No. B.BK.60111.808.2024

# PORTA SYSTEM HYDRO PROTECT™, PORTA SYSTEM ELEGANCE HYDRO PROTECT™

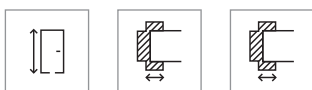

220

60 mm

80 mm



Adjustment

Rebated

Non-rebated

## Construction

### The door frame consists of:

- A door frame head and two jambs, made of wood-polymer composite. It comes with hardware and accessories.
- Architraves (rebated option: 60, 80 mm, non-rebated option: 80 mm) made of wood-polymer composite.

Door frame is produced and delivered to client as a set of elements to assemble on site.

## Notes

- PN-EN 14351-2 standard.
- Door frame should be installed on finished walls (e.g. wall papers) and on a finished floor (e.g. floor panels).
- Size '100' requires third hinge.
- Height '220': 3 hinges as standard.



## HYDRO PROTECT™ door frame cross-section

100% WATERPROOF WOOD-POLYMER COMPOSITE

WATERPROOF GLUE

SURFACE FINISH

Surfaces of the finish marked with 5 drops, with prolonged exposure to water and lack of protection of the door frame with silicone, may slightly lose their aesthetic qualities (visible minor water seepage, damp patches), without losing functional qualities.



Soft CPL, CPL laminate, Premium Plus UV Paint, 3 mm Synchronous board



Synthetic Veneers, Premium Lacquered Veneer

## Adjustment range

Architrave with an extended tongue and with an option for shortening at a specially prepared place.

### EXAMPLE OF ADJUSTMENT FOR PORTA SYSTEM HYDRO PROTECT™ DOOR FRAME, RANGE A-B.

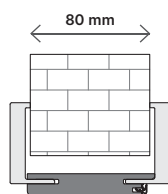

**MINIMUM RANGE**  
adjustment after shortening the architrave tongue

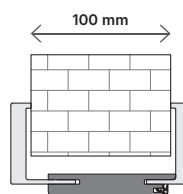

**STANDARD RANGE**  
adjustment without shortened architrave tongue

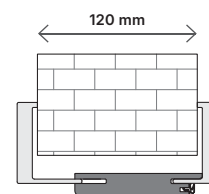

**MAXIMUM RANGE**  
adjustment without shortened architrave tongue

## Interior doors with wooden door frames

See the drawings on the right

Door frame type	Size	S <sub>s</sub>	H <sub>s</sub>	D <sub>s</sub>	S <sub>o</sub>	H <sub>o</sub>	O <sub>s</sub>	O <sub>w</sub>	S <sub>b</sub>	H <sub>b</sub>	S <sub>z</sub> (6)	S <sub>z</sub> (8)	H <sub>z</sub>	T <sub>s/w</sub>
with the door frame: PORTA SYSTEM HYDRO PROTECT™	60	644	2030	40	680	2060	602	2016	646	2038	746	786	architrave (6) / (8) 2088 / 2108	+20 / +10
	70	744			780		702		746		846	886		
	80	844			880		802		846		946	986		
	90	944			980		902		946		1046	1086		
	100	1044			1080		1002		1046		1146	1186		
with door frames: PORTA SYSTEM ELEGANCE HYDRO PROTECT™	60	618	2017	40	690	2060	602	2016	646	2038	-	786	2108	+20 / +10
	70	718			790		702		746		-	886		
	80	818			890		802		846		-	986		
	90	918			990		902		946		-	1086		
	100	1018			1090		1002		1046		-	1186		

In case of doors with a height of '220', the dimensions: H<sub>s</sub>, H<sub>o</sub>, O<sub>w</sub>, H<sub>b</sub>, H<sub>z</sub> should be increased by 200 mm.

Finishes matched to the colour of the door leaf

See all available finishes → 252

<b>PORTA SYSTEM HYDRO PROTECT</b> Door frames for door leaves: <b>ADJUSTMENT RANGE</b>	<b>FINISHED WITH SYNTHETIC VENEERS</b>			<b>PAINTED</b>		
	(1) Synthetic Veneer	(2) Synthetic Veneer/ Soft CPL	(3) CPL laminate	(1) Synthetic Veneer	(2) Premium Lacquered Veneer	(3) Premium Plus UV Paint
A-B	80 ÷ 120					
C-D	120 ÷ 160					
E-F	160 ÷ 200					
G-H	200 ÷ 240					
I-J	240 ÷ 280					
K-L	280 ÷ 320					
M-N	320 ÷ 360					

<b>PORTA SYSTEM ELEGANCE HYDRO PROTECT</b> Door frames for door leaves: <b>ADJUSTMENT RANGE</b>	<b>FINISHED WITH SYNTHETIC VENEERS</b>			<b>PAINTED</b>		
	(1) Synthetic Veneer	(2) Synthetic Veneer/ Soft CPL	(3) CPL laminate	(1) Synthetic Veneer	(2) Premium Lacquered Veneer	(3) Premium Plus UV Paint
B-C	95 ÷ 135					
D-E	135 ÷ 175					
F-G	175 ÷ 215					
H-I	215 ÷ 255					
J-K	255 ÷ 295					
L-M	295 ÷ 335					
N-O	335 ÷ 375					

Additionally

EXTRA CHARGES TO PORTA SYSTEM HYDRO PROTECT

height '220': synthetic veneers

height '220': UV Premium Plus Paint, natural veneer

CPL 0,2 laminates - marked colours\*

CPL 0,2 laminates - UNI MATTE GROUP

PRIME hinges

EXTRA CHARGES TO PORTA SYSTEM ELEGANCE HYDRO PROTECT

height '220': synthetic veneers

height '220': UV Premium Plus Paint, natural veneer

CPL 0,2 laminates - marked colours\*

CPL 0,2 laminates - UNI MATTE GROUP

non-rebated: third 3D hinge

non-rebated: 3D hinges, gold colour

Door frame

PORTA SYSTEM **HYDRO PROTECT™**

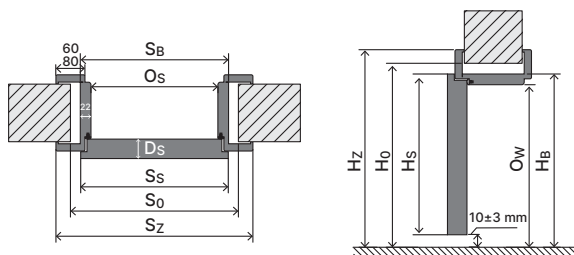

Key to dimensions → 267

PORTA SYSTEM ELEGANCE **HYDRO PROTECT™**

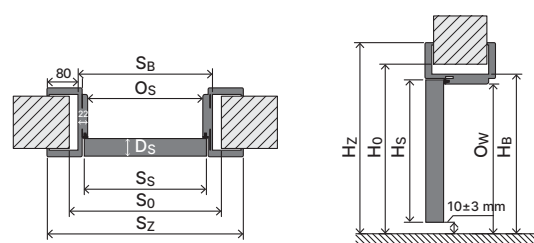

Key to dimensions → 267

Accessories

PORTA SYSTEM **HYDRO PROTECT™**:

- Two or three standard barrel hinges or PRIME hinges (optionally at extra charge).
- Rubber seal set circumferentially.

Accessories

PORTA SYSTEM ELEGANCE **HYDRO PROTECT™**:

- Two sets of 3D adjustable hinges.
- Rubber seal set circumferentially.

# PORTA SYSTEM, PORTA SYSTEM 90°, PORTA SYSTEM GK, GLASS

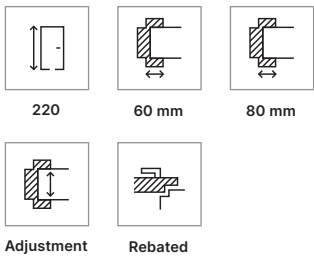

Door frame cross-section



## Construction

- The door frame consists of:
- A door frame head and two jambs, made of wood-polymer composite. It comes with hardware and accessories.
  - Architraves 60,80 mm.

PORTA SYSTEM door frame is produced and delivered to client as a set of elements to assemble on site.

## Adjustment range

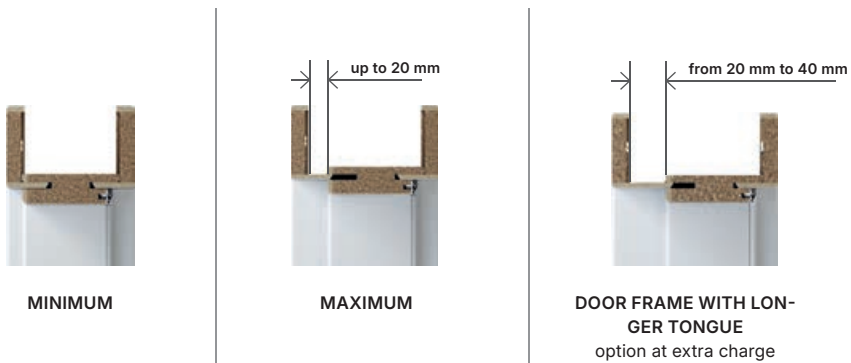

## Architraves joining Porta System Elegance 90°



Flush surface.  
Door frame finished with synthetic veneer.

Illustrative drawing



Main beam recessed.  
Door frame finished with Premium Plus UV Paint.

Illustrative drawing



Flush surface.  
Door frame finished with Natural veneer.

Illustrative drawing



## Interior doors with wooden door frames

See the figure on the right.

Door frame type	Size	S <sub>s</sub>	H <sub>s</sub>	D <sub>s</sub>	S <sub>o</sub>	H <sub>o</sub>	O <sub>s</sub>	O <sub>w</sub>	S <sub>b</sub>	H <sub>b</sub>	S <sub>z</sub> (6)	S <sub>z</sub> (8)	H <sub>z</sub>	T <sub>s/w</sub>
with a door frame: PORTA SYSTEM, PORTA SYSTEM 90°	60	644	2030	40	680	2060	602	2016	646	2038	746	786	architrave (6) / (8) 2088 / 2108	+20 / +10
	70	744			780		702		746		846	886		
	80	844			880		802		846		946	986		
	90	944			980		902		946		1046	1086		
	100	1044			1080		1002		1046		1146	1186		

NOTE: S<sub>z</sub> and H<sub>z</sub> dimensions of door frame in Natural veneers are given with tolerance -1 mm/ + 3 mm. In case of doors with a height of '220', the dimensions: H<sub>s</sub>, H<sub>o</sub>, O<sub>w</sub>, H<sub>b</sub>, H<sub>z</sub> should be increased by 200 mm.

Finish matched to the door leaf finish

See all available finishes → 252

Door frames for door leaves: ADJUSTMENT RANGE	FINISHED WITH SYNTHETIC VENEERS			PAINTED		
	(1) Synthetic Veneer	(2) Synthetic Veneer/ Soft CPL	(3) CPL laminate	(1) Synthetic Veneer	(2) Premium Lacquered Veneer	(3) Premium Plus UV Paint
A	75 ÷ 95					
B	95 ÷ 115					
C	120 ÷ 140					
D	140 ÷ 160					
E	160 ÷ 180					
F	180 ÷ 200					
G	200 ÷ 220					
H	220 ÷ 240					
I	240 ÷ 260					
J	260 ÷ 280					
K	280 ÷ 300					
L	300 ÷ 320					
M	320 ÷ 340					
N*	340 ÷ 360					

\*Range N is not available in Premium Plus UV Paint and Natural Veneer finishes

**Additionally**

- height '220': synthetic veneers
- height '220': UV Premium Plus Paint, natural veneer
- CPL 0,2 laminates - marked colours\*
- CPL 0,2 laminates - UNI MATTE GROUP
- finishing with natural veneer.: White Oak, Satin
- finishing with Natural veneer: Select: Black
- finishing with natural veneer.: matte: Oak, Bianco Oak, Taupe Walnut

- finishing with natural veneer.: Walnut
- changed architrave joining from 45 to 90 degrees: all finishes
- architrave with wide tongue: synthetic veneers
- architrave with wide tongue: Premium Plus UV Paint
- architrave with wide tongue: natural veneers
- PRIME hinges

**Door frame**

**PORTA SYSTEM**

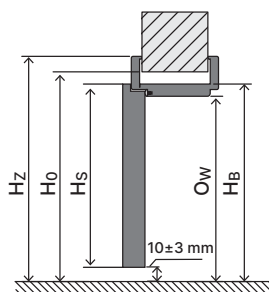
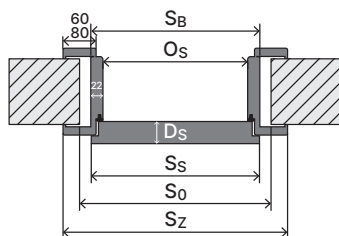

**Notes**

- Technical Assessment ITB-KOT-2018/0358, issue 2.
- Door frame should be installed on finished walls (e.g. wall papers) and on a finished floor (e.g. floor panels).
- The door frame is also available in a 'tunnel' option (without a rebate, a seal, hinges or a strike plate). Available up to the K range. Larger adjustment range can be achieved by using the Adjustment Panel.
- Size '100' requires third hinge.
- Height '220'; three hinges as standard.
- Range M finished with Premium Plus UV Paint and with Natural veneers consists of beam for L range and architrave with long tongue.
- Door frames are also available in synthetic veneer for self-painting – at the price of door frames from group 1.

**Accessories - included in the price of the door frame**

**PORTA SYSTEM, PORTA SYSTEM 90°**

**Synthetic veneers:**

- Two or three standard barrel hinges or PRIME hinges (optionally at extra charge).
- Rubber seal set circumferentially.

**Natural veneers:**

- Three standard barrel hinges or PRIME hinges.
- Rubber seal set circumferentially.

**PORTA SYSTEM GK/GLASS**

- Strike plate (small).
- Rubber seal set circumferentially.
- Hinge receivers, 2 PCs for size '60'-'90', 3 PCs for size '100'.
- Price of a glass door set = price of the glass pane + price of the PORTA System GK/GLASS door frame + price of hardware.

**NOTE!** Hinges are not included in a door frame set.

Key to dimensions → 267

Detailed offer is also available on [www.portadoors.com](http://www.portadoors.com)

# PORTA SYSTEM ELEGANCE, PORTA SYSTEM ELEGANCE 90°

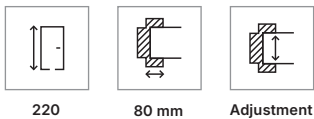

220

80 mm

Adjustment



Non-rebated

## Construction

The door frame consists of:

- A door frame head and two jambs, made of wood-based material. It comes with necessary hardware and accessories.
- 80 mm architraves.

Architrave edge radius:

- "Arris" for natural veneers.
- 1.5 mm for synthetic veneers.
- 3 mm for CPL veneer 0.2 mm.

PORTA SYSTEM ELEGANCE is produced and delivered to client as a set of elements to assemble on site.

Accessories - included in the price of the door frame

- Two sets of 3D adjustable hinges.
- Rubber seal set circumferentially.

## Door frame cross-section

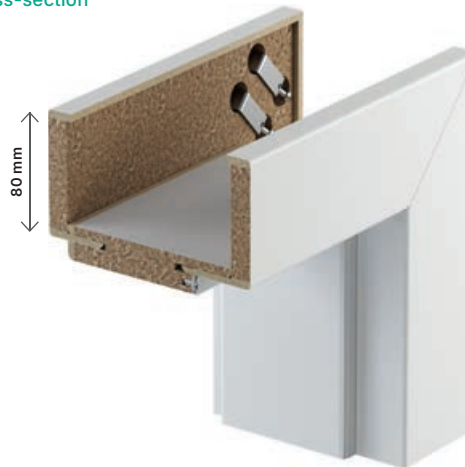

## Adjustment range

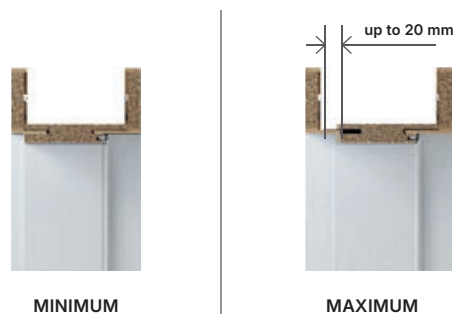

## Interior doors with wooden door frames

See the figure on the right.

Door frame type	Size	S <sub>s</sub>	H <sub>s</sub>	D <sub>s</sub>	S <sub>o</sub>	H <sub>o</sub>	O <sub>s</sub>	O <sub>w</sub>	S <sub>b</sub>	H <sub>b</sub>	S <sub>z</sub> (6)	S <sub>z</sub> (8)	H <sub>z</sub>	T <sub>s/w</sub>
with door frames: PORTA SYSTEM ELEGANCE, PORTA SYSTEM ELEGANCE 90°	60	618	2017	40	690	2060	602	2016	646	2038	-	786	2108	+20/+10
	70	718			790		702		746		-	886		
	80	818			890		802		846		-	986		
	90	918			990		902		946		-	1086		
	100	1018			1090		1002		1046		-	1186		

NOTE: S<sub>z</sub> and H<sub>z</sub> dimensions of door frame in Natural veneers are given with tolerance -1 mm/ + 3 mm. In the case of doors with a height of '220', the dimensions: H<sub>s</sub>, H<sub>o</sub>, O<sub>w</sub>, H<sub>b</sub>, H<sub>z</sub> should be increased by 200 mm.

Finish matched to the door leaf finish

See all available finishes → 252

Door frames for door leaves: PORTA SYSTEM ELEGANCE ADJUSTMENT RANGES		FINISHED WITH SYNTHETIC VENEERS			PAINTED			FINISHED WITH NATURAL VENEER
		(1) Synthetic Veneer	(2) Synthetic Veneer /Soft CPL	(3) CPL laminate	(1) Synthetic Veneer	(2) Premium Lacquered Veneer	(3) Premium Plus UV Paint	Natural Veneers
A	75 ÷ 95 <b>NEW</b>							
B	95 ÷ 115							
C	120 ÷ 140							
D	140 ÷ 160							
E	160 ÷ 180							
F	180 ÷ 200							
G	200 ÷ 220							
H	220 ÷ 240							
I	240 ÷ 260							
J	260 ÷ 280							
K	280 ÷ 300							
L	300 ÷ 320							
M	320 ÷ 340							
N*	340 ÷ 360							

\*Range N is not available in Premium Plus UV Paint and Natural Veneer finishes

Additionally

height '220': synthetic veneers	architrave with wide tongue: synthetic veneers
height '220': UV Premium Plus Paint, natural veneer	architrave with wide tongue: Premium Plus UV Paint
CPL 0,2 laminates - marked colours*	architrave with wide tongue: natural veneers
CPL 0,2 laminates - UNI MATTE GROUP	changed architrave joining from 45 to 90 degrees: synthetic veneers
finishing with natural veneer.: White Oak, Satin	changed architrave joining from 45 to 90 degrees: Premium Plus UV Paint
finishing with Natural veneer: Select: Black	changed architrave joining from 45 to 90 degrees: natural veneers
finishing with natural veneer.: matte: Oak, Bianco Oak, Taupe Walnut	non-rebated: third 3D hinge
finishing with natural veneer.: Walnut	non-rebated: 3D hinges, gold colour
architraves 100 mm PS ELEGANCE frame finished with natural veneer)	magnetic lock strike plate (for LUMIA)

ARCHITRAVES JOINING  
PORTA SYSTEM ELEGANCE  
90°



Flush surface.  
Door frame finished with synthetic veneer.

Illustrative drawing



Main beam recessed.  
Door frame finished with Premium Plus UV Paint.

Illustrative drawing



Flush surface.  
Door frame finished with Natural veneer.

Illustrative drawing



Door frame

PORTA SYSTEM ELEGANCE

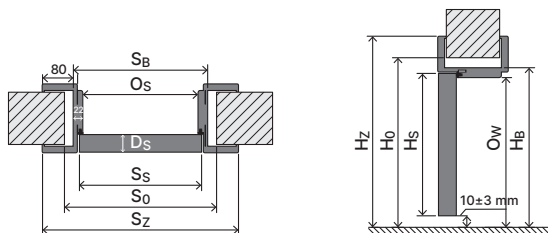

Key to dimensions → 267

Detailed offer is also available on [www.portadoors.com](http://www.portadoors.com)

Notes

- Technical Assessment ITB-KOT-2018/0358, issue 2.
- Door frame should be installed on finished walls (e.g. wall papers) and on a finished floor (e.g. floor panels).
- The door frame is also available in a 'tunnel' option (without a rebate, a seal, hinges or a strike plate). (it regards PS ELEGANCE).
- Height '220'; three hinges as standard.
- Range M finished with Premium Plus UV Paint and with Natural veneers consists of beam for L range and architrave with long tongue.
- Range A - in order to obtain a minimum wall thickness of 75 mm, the installer must shorten (cut) the tongue of the adjustable architrave.
- Door frames are also available in synthetic veneer for self-painting – at the price of door frames from group 1.
- If the hinge box does not fit within the wall opening, it is necessary to make a recess as shown in the drawing → 266

# PORTA SYSTEM with reverse rebate

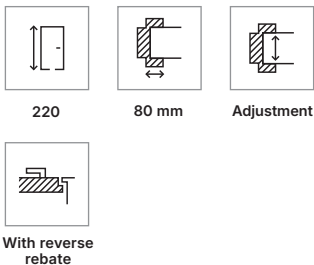

## Construction

### The door frame consists of:

- A door frame head and two jambs, made of wood-based material. It comes with necessary hardware and accessories.
- Architraves 80 mm on both sides.

### Architrave edge radius:

- "Arris" for natural veneers.
- 1.5 mm for synthetic veneers.
- 3 mm for CPL veneer 0.2 mm.

Door frame is produced and delivered to client as a set of elements to assemble on site.

### Accessories - included in the price of the door frame

- Two sets of 3D adjustable hinges.
- Rubber seal set circumferentially.

## Door frame cross-section



## Adjustment range

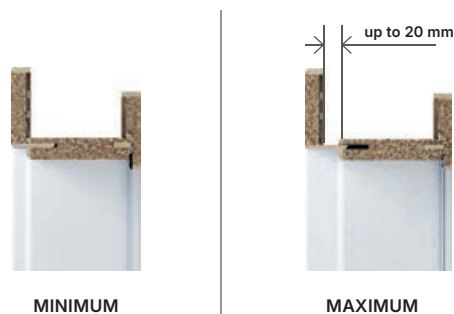

## Interior doors with wooden door frames

See the figure on the right.

Door frame type	Size	S <sub>s</sub>	H <sub>s</sub>	D <sub>s</sub>	S <sub>o</sub>	H <sub>o</sub>	O <sub>s</sub>	O <sub>w</sub>	S <sub>b</sub>	H <sub>b</sub>	S <sub>z</sub> (6)	S <sub>z</sub> (8)	H <sub>z</sub>	T <sub>s/w</sub>
with a door frame: PORTA SYSTEM with reverse rebate**	60	639	2027	40	720	2080	626	2028	691	2061	-	831 **	2130 **	±10 / ±5
	70	739			820		726		791		-	931 **		
	80	839			920		826		891		-	1031 **		
	90	939			1020		926		991		-	1131 **		
	100	1039			1120		1026		1091		-	1231 **		

**NOTE:** S<sub>z</sub> and H<sub>z</sub> dimensions of door frame in Natural veneers are given with tolerance -1 mm/ + 3 mm.

\*\* Outer dimensions (on the narrower side of the door leaf) S<sub>z</sub> and H<sub>z</sub> are identical to the dimensions of doors with PORTA SYSTEM ELEGANCE door frames.

**NOTE:** In case of doors with a height of '220', the dimensions: H<sub>s</sub>, H<sub>o</sub>, O<sub>w</sub>, H<sub>b</sub>, H<sub>z</sub> should be increased by 200 mm.

Finish matched to the door leaf finish

See all available finishes → 252

Door frames for door leaves: ADJUSTMENT RANGE	FINISHED WITH SYNTHETIC VENEERS			PAINTED			FINISHED WITH NATURAL VENEER Natural veneers
	(1) Synthetic Veneer	(2) Synthetic Veneer/Soft CPL	(3) CPL laminate	(1) Synthetic Veneer	(2) Premium Lacquered Veneer	(3) Premium Plus UV Paint	
B	95 ÷ 115						
C	120 ÷ 140						
D	140 ÷ 160						
E	160 ÷ 180						
F	180 ÷ 200						
G	200 ÷ 220						
H	220 ÷ 240						
I	240 ÷ 260						
J	260 ÷ 280						
K	280 ÷ 300						

Additionally

height '220': synthetic veneers	43	52,03	finishing with Natural veneer: Select: Black	43	52,03
height '220': UV Premium Plus Paint, natural veneer	57	68,97	finishing with natural veneer.: matte: Oak, Bianco Oak, Taupe Walnut	19	22,99
CPL 0,2 laminates - marked colours*	15	18,15	finishing with natural veneer.: Walnut	23	27,83
CPL 0,2 laminates - UNI MATTE GROUP	21	25,41	reverse rebate: third 3D hinge	56	67,76
finishing with natural veneer.: White Oak, Satin	43	52,03	reverse rebate: 3D hinges, gold colour	16	19,36

Door opening direction



Door frame

PORTA SYSTEM with reverse rebate

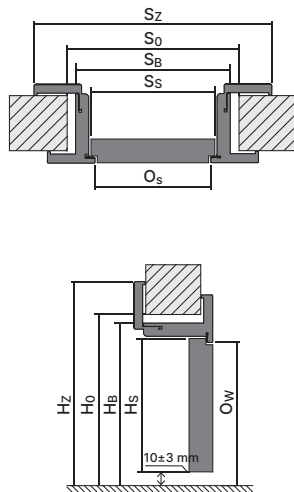

Key to dimensions → 267

Detailed offer is also available on [www.portadoors.com](http://www.portadoors.com)

Notes

- Technical Assessment ITB-KOT-2018/0358, issue 2.
- Door frame should be installed on finished walls (e.g. wall papers) and on a finished floor (e.g. floor panels).
- Height '220' - three hinges as standard.
- If the hinge box does not fit within the wall opening, it is necessary to make a recess as shown in the drawing → 266

Application

PORTA SYSTEM door frame with reversed rebate is available in collections:

- painted collections: PORTA VECTOR Premium, PORTA DESIRE, PORTA FOCUS Premium, PORTA GRANDE, PORTA ART DECO, PORTA OSLO, AIR, WATER, PORTA FACTOR, PORTA VERRA, PORTA IMPERIAL, PORTA ORNATO
- natural veneer collections: NATURE CLASSIC, NATURE GRANDE, NATURE LINE, NATURE OSLO, NATURE VECTOR, NATURE SPACE, CORDOBA, MADRID, SEVILLE, EARTH, NATURE VERDINO
- synthetic veneer collections: PORTA INSPIRE, PORTA CONCEPT, PORTA VERTE PREMIUM, PORTA BALANCE, PORTA HARMONY, PORTA LOFT, PORTA FOCUS, PORTA LEVEL, PORTA LINE, PORTA RESIST, PORTA CPL, AIR, PORTA CRAFT, PORTA LEVEL LINE, PORTA VIGO

# LEVEL

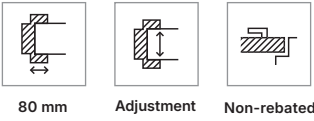

## Construction

- The door frame consists of:
- Door frame head and two jambs, made of wood-based material. It comes with hardware and accessories.
  - 80 mm architraves.
  - Two vertical panels (order separately).

The LEVEL panel has a vertical grain direction (note: the wood grain pattern on the panels may be misaligned with the pattern on the door leaves).

For selected colours - horizontal grain.

- (1) **Rustic:** Mauvella Oak, Golden Craft Oak, Catania Oak.
- (2) **Rustic:** Hikora Jackson, Hamilton English Oak, Dark Hikora Jackson.
- (2) **Modern:** Salvador Bleached Oak, Salvador Light Oak, Arles Toffee Oak, Arles Natural Oak, Arles Dark Oak.
- (2) **Traditional:** Matte Oak, Dark Matte Oak.
- Natural veneer Select

### Architrave edge radius:

- 1.5 mm, for natural veneers "arris".

LEVEL door frame is produced and delivered to a client as a set of elements to be assembled on site.

### Accessories - included in the price of the door frame

- Two sets of 3D adjustable hinges.
- Rubber seal set circumferentially.

## Door frame cross-section



LEVEL DOOR FRAME (SET) = DOOR BASE + UPPER PANELS

## Adjustment range

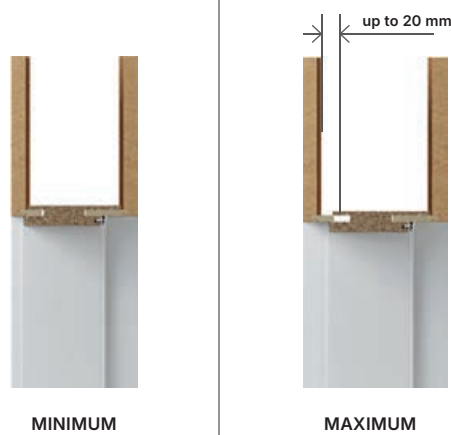

## Interior doors with wooden door frames

See the figure on the right.

Door frame type	Size	S <sub>s</sub>	H <sub>s</sub>	D <sub>s</sub>	S <sub>o</sub>	H <sub>o</sub>	O <sub>s</sub>	O <sub>w</sub>	S <sub>b</sub>	H <sub>b</sub>	S <sub>z</sub> (6)	S <sub>z</sub> (8)	H <sub>z</sub>	T <sub>s/w</sub>
with a door frame: LEVEL	60	618	2017	40	690	2070	602	2016	646	2046	-	786	upper panel (20) / (100) 2228 / 3028	+20 / +10
	70	718			790		702		746		-	886		
	80	818			890		802		846		-	986		
	90	918			990		902		946		-	1086		
	100	1018			1090		1002		1046		-	1186		

NOTE: S<sub>z</sub> and H<sub>z</sub> dimensions of door frame in Natural veneers are given with tolerance -1 mm/ + 3 mm.

Finishes matched to the colour of the door leaf

See all available finishes ➔ 252

Door frames for door leaves: ADJUSTMENT RANGE	
B	95 ÷ 115
C	120 ÷ 140
D	140 ÷ 160
E	160 ÷ 180
F	180 ÷ 200
G	200 ÷ 220
H	220 ÷ 240
I	240 ÷ 260
J	260 ÷ 280
K	280 ÷ 300

FINISHED WITH SYNTHETIC VENEERS		PAINTED	FINISHED WITH NATURAL VENEER
(1) Synthetic Veneer	(2) Synthetic Veneer/ Soft CPL	(2) Synthetic Lacquered Veneer	(3) Premium Plus UV Paint Natural veneers

Panels for door leaves: UPPER PANELS	
200 mm (2x)	
1000 mm (2x)	
200 and 1000 mm (1/1)	

FINISHED WITH SYNTHETIC VENEERS		PAINTED	FINISHED WITH NATURAL VENEER
(1) Synthetic Veneer	(2) Synthetic Veneer /Soft CPL	(2) Synthetic Lacquered Veneer	(3) Premium Plus UV Paint Natural Veneers

Additionally

finishing with natural veneer: matte: Oak, Bianco Oak, Taupe Walnut

non-rebated: third 3D hinge

non-rebated: 3D hinges, gold colour

Door frame

LEVEL

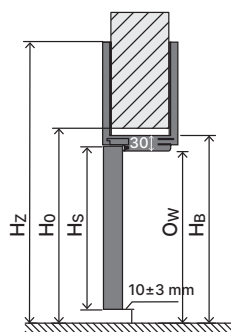
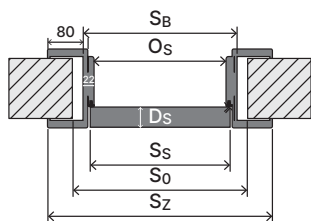

Notes

- Technical Assessment ITB-KOT-2018/0358, issue 2.
- Door frame should be installed on finished walls (e.g. wall papers) and on a finished floor (e.g. floor panels).
- Door frame is also available in a 'tunnel' option (without a rebate, a seal, hinges or a strike plate).
- If the hinge box does not fit within the wall opening, it is necessary to make a recess as shown in the drawing ➔ 266

Key to dimensions ➔ 267

Detailed offer is also available on [www.portadoors.com](http://www.portadoors.com)

# MINIMAX

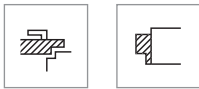

Rebated

Fixed

## Construction

The door frame consists of:

- Door frame head and two jambs, made of MDF, with hardware and accessories.
- Architraves (at additional charge).
- Quarter round (at additional charge).

Door frame is produced and delivered to client as a set of elements to assemble on site.

## Accessories - included in the price of the door frame

### MINIMAX 60 mm

Available only in synthetic veneers from group 1:

- Two or three standard barrel hinges or PRIME hinges (optionally at extra charge).
- Door stops.
- Dowel pins, hole plugs.

### MINIMAX 100 mm

- Two or three standard barrel hinges or PRIME hinges (optionally at extra charge).
- Rubber seal set circumferentially.
- Humidity protecting plugs for bottom part of a door frame.

## Door frame 60 mm



**BASIC OPTION**  
(without architraves)

## Door frame 100 mm



**FLAT ARCHITRAVES**  
(90° joint)



**ROUNDED ARCHITRAVES**  
(45° joint)

## Interior doors with wooden door frames

See the figure on the right.

Door frame type	Size	S <sub>s</sub>	H <sub>s</sub>	D <sub>s</sub>	S <sub>o</sub>	H <sub>o</sub>	O <sub>s</sub>	O <sub>w</sub>	S <sub>b</sub>	H <sub>b</sub>	S <sub>z</sub> (6)	s <sub>z</sub> (8)	H <sub>z</sub>	T <sub>s/w</sub>
with door frames: MINIMAX 60 mm / MINIMAX 100 mm	60	644	2030	40	710	2075	602	2016	690	2060	800	-	2115	+20 / +10
	70	744			810		702		790		900	-		
	80	844			910		802		890		1000	-		
	90	944			1010		902		990		1100	-		
	100	1044			1110		1002		1090		1200	-		

Finish matched to the door leaf finish

See all available finishes [➔](#) 252

FINISHED WITH SYNTHETIC VENEERS			PAINTED		
(1) Synthetic Veneer	(2) Synthetic Veneer/ Soft CPL	(3) CPL laminate	(1) Synthetic Veneer	(2) Synthetic Lacquered Veneer	(3) Premium Plus UV Paint

Additionally

CPL 0,2 laminates - marked colours\*

CPL 0,2 laminates - UNI MATTE GROUP

PRIME hinges

Architraves for MINIMAX door frame

FLAT ARCHITRAVES



ROUNDED ARCHITRAVES



QUARTER ROUNDS

(2,15 m x 12 mm x 22 mm)



FINISHED WITH SYNTHETIC VENEERS			PAINTED		
(1) Synthetic Veneer	(2) Synthetic Veneer/Soft CPL	(3) CPL laminate	(1) Synthetic Veneer	(2) Premium Lacquered Veneer	(3) Premium Plus UV paint

Door frame

MINIMAX

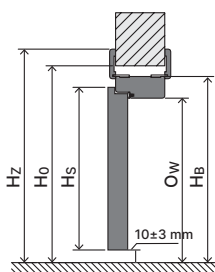
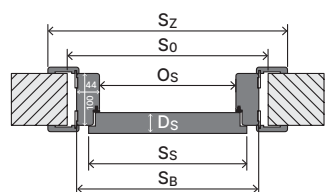

Notes

- Technical Assessment ITB-KOT-2018/0358, issue 2.
- Door frame should be installed on finished walls (e.g. wall papers) and on a finished floor (e.g. floor panels).
- A door frame with a width of 100 mm can also be ordered as a 'tunnel' option (i.e. made without a rebate and without a seal, hinges and strike plate).
- Door frames and architraves are available in unpainted option (for self-finishing).
- Size '100' requires third hinge.
- Door frames, architraves and quarter rounds are also available in synthetic veneer for self-painting. At the price of door frames and architraves from group 1.

Key to dimensions [➔](#) 267

Detailed offer is also available on [www.portadoors.com](http://www.portadoors.com)

# PORTA RENOVA



Adjustment



Rebated

## Construction

The door frame consists of:

- Door frame head and two jambs, made of wood-based materials .
- Architraves.

PORTA RENOVA is produced and delivered to client as a set of elements to assemble on site.

## Accessories - included in the price of the door frame

- Two or three standard barrel hinges.

The PORTA RENOVA offer includes:

- PORTA RENOVA door frame to work with door leaves, ranges from A to J + size '5' – 55÷75.
- Tunnel version, ranges from A to J.
- Head and jambs with a tongue (broadening PORTA RENOVA adjustment) from 'A' to 'J'.

## Door frame cross-section



## Adjustment range



MINIMUM



MAXIMUM

## Interior doors with wooden door frames

See the figure on the right.

Door frame type	Size	S <sub>s</sub>	H <sub>s</sub>	D <sub>s</sub>	S <sub>o</sub>	H <sub>o</sub>	O <sub>s</sub>	O <sub>w</sub>	S <sub>b</sub>	H <sub>b</sub>	S <sub>z</sub> (6)	S <sub>z</sub> (8)	H <sub>z</sub>	T <sub>s/w</sub>
with RENOVA door frame ***	60	644	2030	40	596	2016	558	1994	584	2007	746	-	2088	+15 / -6
	70	744			696		658		684		846	-		
	80	844			796		758		784		946	-		
	90	944			896		858		884		1046	-		
	100	1044			996		958		984		1146	-		

\*\*\*S<sub>o</sub>/H<sub>o</sub> - refers to the width/height measured in the opening height, width of the old steel door frame. T<sub>s/w</sub> - tolerance +15 mm depends on a construction of the old door frame.

Finish matched to the door leaf finish

See all available finishes → 252

Door frames for door leaves:		FINISHED WITH SYNTHETIC VENEERS			PAINTED	
ADJUSTMENT RANGE		(1) Synthetic Veneer	(2) Synthetic Veneer/ Soft CPL	(3) CPL laminate	(1) Synthetic Veneer	(2) Synthetic Lacquered Veneer
S	55 ÷ 75					
A	75 ÷ 95					
B	95 ÷ 115					
C	120 ÷ 140					
D	140 ÷ 160					
E	160 ÷ 180					
F	180 ÷ 200					
G	200 ÷ 220					
H	220 ÷ 240					
I	240 ÷ 260					
J	260 ÷ 280					

Door frame

PORTA RENOVA

Notes

- PN-EN 14351-2:2018-2 (only for the door set: RENOVA door frame and PORTA interior door leaf).
- Door frame should be installed on finished walls (e.g. wall papers) and on a finished floor (e.g. floor panels).
- The frame can also be ordered as the 'tunnel' option (i.e. made without the rebate, seal, hinges and lock catch).
- Door frame not available in the following colours: Cashmere, Fjord, Olive.
- Size '100' requires third hinge.
- You can order additional broadening (head and jambs).
- Standard door leaves can be used with this door frame. In the case of installing a handle with an escutcheon wider than 44 mm, a dedicated door leaf with a 72/60 mm lock should be ordered.
- All crooks and unevenness of a wall and old door frame have to be taken into consideration during wall opening measurement.

Due to the complicated installation, it is recommended to use the services of an Authorized Installation Group.

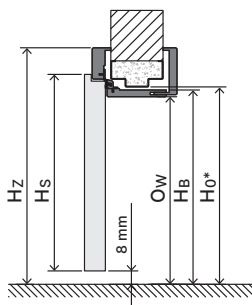
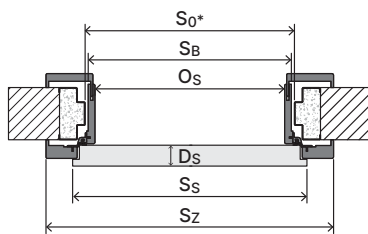

Key to dimensions → 267

Detailed offer is also available on [www.portadoors.com](http://www.portadoors.com)

# Steel PORTA SYSTEM

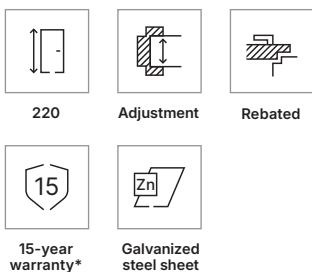

## Construction

This adjustable door frame is made out of the best quality galvanized steel, 1,2 mm thick.

### The door frame consists of:

- Fixed part (fitted to the wall thickness) mounted on a wall (with necessary accessories).
- Adjustable part, wrapping the wall -5, +20 mm.
- Rubber seal set circumferentially.
- Barrel hinges.

## Door frame size

- '60', '70', '80', '90', '100' and '120' ÷ '200'
- To be installed on the finished floor '0'.

## Accessories - included in the price of the door frame

- Two or three standard barrel hinges.
- Three hinges (in the door frame with dimension '100').
- Rubber seal set circumferentially, white, grey, brown, cream, anthracite, black.
- Fixed part mounted on a wall.
- Reinforcement for the lock strike.

\* For the door frame construction and coating.

## Door frame cross-section



## Door frame ranges

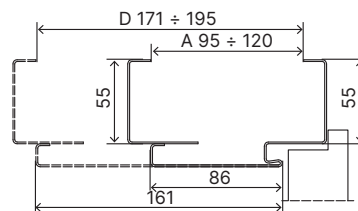

## Adjustment range

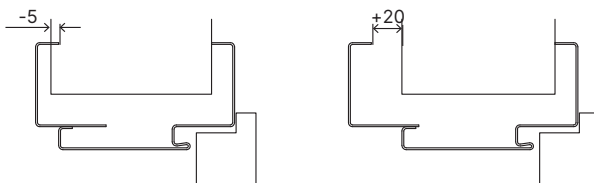

## Interior doors with steel door frames

See the figure on the right.

Door frame type	Size	S <sub>s</sub>	H <sub>s</sub>	D <sub>s</sub>	S <sub>o</sub>	H <sub>o</sub>	O <sub>s</sub>	O <sub>w</sub>	S <sub>B</sub>	H <sub>B</sub>	S <sub>Z</sub>	H <sub>Z</sub>	T <sub>s/w</sub>
with Steel PORTA SYSTEM door frame	60	644	2030	40	675	2055	596	2016	646	2041	736	2086	+10 / +5
	70	744			775		696		746		836		
	80	844			875		796		846		936		
	90	944			975		896		946		1036		
	100	1044			1075		996		1046		1136		

NOTE: In case of doors with a height of '220', the dimensions: H<sub>s</sub>, H<sub>o</sub>, O<sub>w</sub>, H<sub>B</sub>, H<sub>Z</sub> should be increased by 200 mm.

Finish matched to the door leaf finish

See larger visualisations [➔](#) 265

Premium Polyester Paint



Polyester Premium Paint (GROUP II)



Premium Polyester Paint (GROUP III)



Steel PORTA SYSTEM	
ADJUSTMENT RANGE	
A	95 ÷ 120 mm
B	121 ÷ 145 mm
C	146 ÷ 170 mm
D	171 ÷ 195 mm

Additionally

height '220'

premium polyester paint - GROUP II

premium polyester paint - GROUP III

Door frame

Steel PORTA SYSTEM

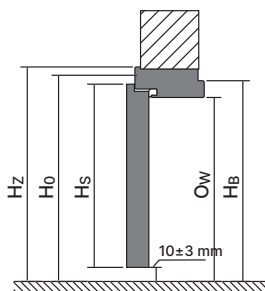
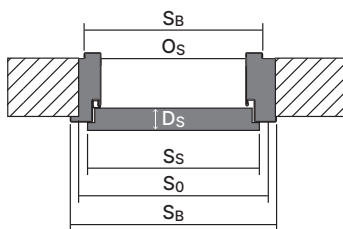

Notes

- National Technical Assessment ITB-KOT-2017/0245, issue 2.
- Certificate of Conformity No. 0004/D/W, ITB Warsaw.
- Door frame should be installed on finished walls (e.g. wall papers) and on a finished floor (e.g. floor panels).
- Polyester Premium paint Anthracite HPL/CPL is dedicated for door leaves finished with HPL/CPL Anthracite.

Key to dimensions [➔](#) 267

Detailed offer is also available on [www.portadoors.com](http://www.portadoors.com)

# Steel PORTA SYSTEM ELEGANCE

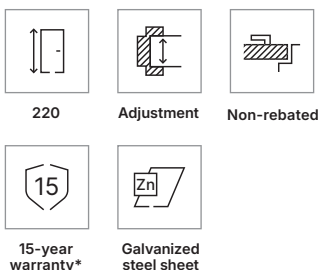

## Construction

This adjustable door frame is made out of the best quality galvanized steel, 1,2 mm thick.

### The door frame consists of:

- Fixed part (fitted to the wall thickness) mounted on a wall (with necessary accessories).
- Adjustable part, wrapping the wall -5, +20 mm.
- Rubber seal set circumferentially.
- 3D barrel hinges.

## Door frame size

- '60', '70', '80', '90', '100' and '120' ÷ '200'
- To be installed on the finished floor '0'.

## Accessories - included in the price of the door frame

- Two 3D adjustable hinges.
- Rubber seal set circumferentially, white, grey, brown, cream, anthracite, black.
- Fixed part mounted on a wall.

## Door frame cross-section



## Door frame ranges

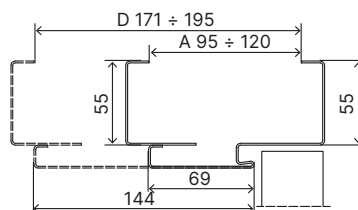

## Adjustment range

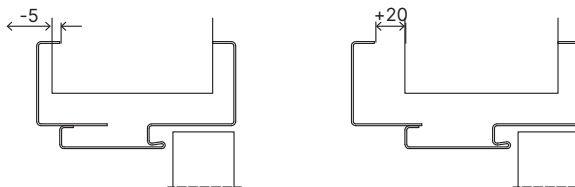

\* For the door frame construction and coating.

## Interior doors with steel door frames

Door frame type	Size	S <sub>s</sub>	H <sub>s</sub>	D <sub>s</sub>	S <sub>o</sub>	H <sub>o</sub>	O <sub>s</sub>	O <sub>w</sub>	S <sub>B</sub>	H <sub>B</sub>	S <sub>Z</sub>	H <sub>Z</sub>	T <sub>s/w</sub>
Steel PORTA SYSTEM ELEGANCE**	60	618	2017	40	676	2056	596	2016	646	2041	736	2086	+10 / +5
	70	718			776		696		746		836		
	80	818			876		796		846		936		
	90	918			976		896		946		1036		
	100	1018			1076		996		1046		1136		

**NOTE:** In case of doors with a height of '220', the dimensions: H<sub>s</sub>, H<sub>o</sub>, O<sub>w</sub>, H<sub>B</sub>, H<sub>Z</sub> should be increased by 200 mm. If the hinge box does not fit within the wall opening, it is necessary to make a recess as shown in the drawing ➔ 266

Finish matched to the door leaf finish

See larger visualisations → 265

Premium Polyester Paint



Polyester Premium Paint (GROUP II)



Premium Polyester Paint (GROUP III)



Steel PORTA SYSTEM ELEGANCE	
ADJUSTMENT RANGE	
A	95 ÷ 120 mm
B	121 ÷ 145 mm
C	146 ÷ 170 mm
D	171 ÷ 195 mm

Additionally

- height '220'

---

- premium polyester paint - GROUP II

---

- premium polyester paint - GROUP III

---

- non-rebated: third 3D hinge

---

- non-rebated: 3D hinges, gold colour

Door frame

Steel PORTA SYSTEM ELEGANCE

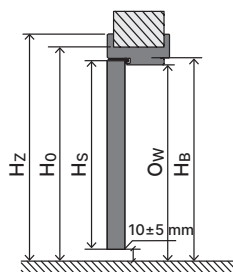
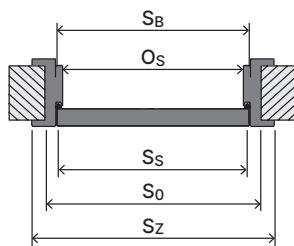

Notes

- National Technical Assessment ITB-KOT-2017/0245, issue 2.
- Certificate of Conformity No. 0004/D/W, ITB Warsaw.
- Door frame should be installed on finished walls (e.g. wall papers) and on a finished floor (e.g. floor panels).
- Polyester Premium paint Anthracite HPL/CPL is dedicated for door leaves finished with HPL/CPL Anthracite.

Key to dimensions → 267

Detailed offer is also available on [www.portadoors.com](http://www.portadoors.com)

# Door frame extensions

## Tip

If you need a door frame for a wider wall, you go for additional solutions: a tunnel extension or an adjustment panel. And if you are looking for bigger adjustment than the standard (up to 20 mm), use the so-called "wide tongue," which increases the adjustment range to 40 mm.

## Door frame adjustment

The door frame can be widened to fit the range of the wall by:

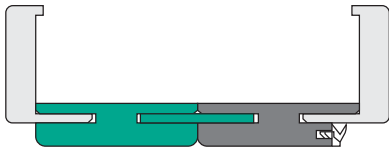

### Tunnel extension (combined door frame)

Designed for large wall ranges (max. 588 mm). The solution consists of a standard door frame and an additional widening beam with a connector. Check the dimensions in the table on page [267](#)

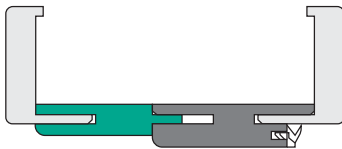

### Adjustment Panel

A solution that allows the standard door frame (max. 460 mm) to be widened with an additional MDF panel; adjustment panels are available in widths of 80 and 160 mm.



## Finishes

See larger visualisations [252](#)

ADJUSTMENT PANELS for PORTA SYSTEM door frame

(1) Synthetic Veneer

(2) Synthetic Veneer/ Soft CPL

(3) CPL laminate

(2) Premium Lacquered Veneer

(3) Premium Plus UV Paint

Natural veneers

adjusting panel: Natural veneer, White Oak, Satin

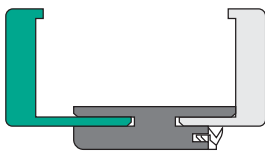

### Wide tongue

The architrave with a widened adjusting tongue allows the wall range to be increased by an additional 20 mm (while maintaining the 20 mm adjustment).

#### DOOR FRAME WITH STANDARD ARCHITRAVE



MINIMUM

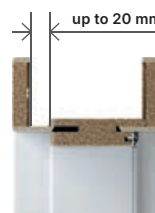

MAXIMUM

#### DOOR FRAME WITH WIDER TONGUE option at extra charge

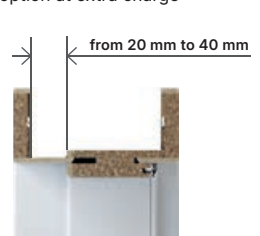

Option available for door frames in all finishes:

PORTA SYSTEM  
PORTA SYSTEM ELEGANCE

## Finishes

See larger visualisations [252](#)

Synthetic veneers

Premium Plus UV Paint

Natural veneers

## Skirting boards

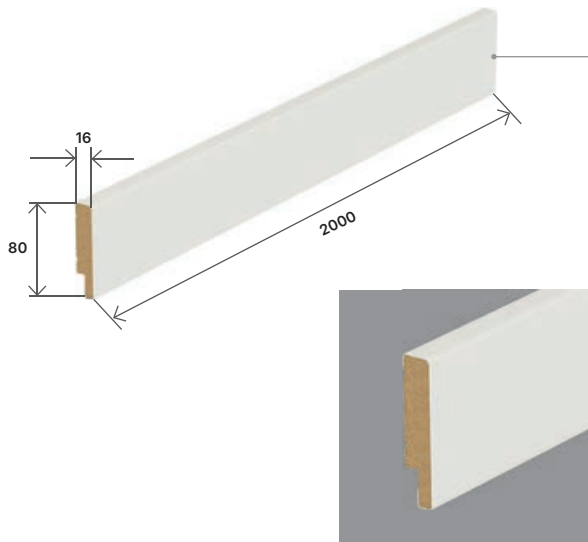

## Trims

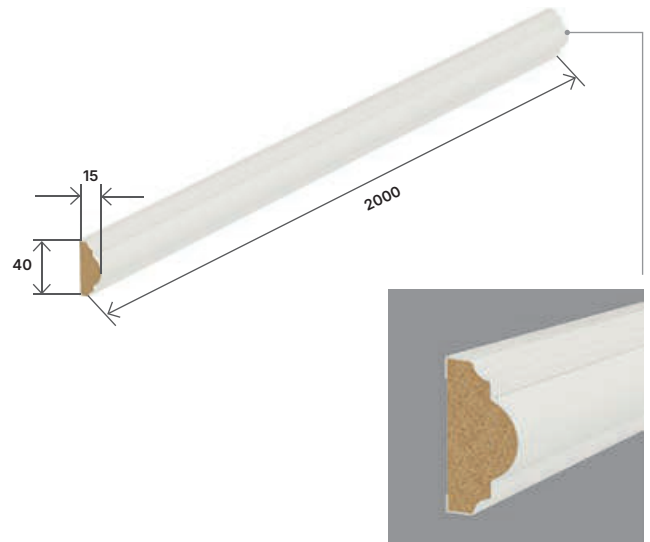

### Finishes

See larger visualisations [➤](#) 252

#### SKIRTING BOARDS

##### Premium Plus UV Paint



White Cashmere Grey Sage

##### (1) Uni Colours



White Fjord Olive

##### (1) Prime Veneer



Prime Veneer

##### (2) Uni Colours



White Cashmere Grey Fjord Olive Black

##### (2) Traditional



Matte Oak Natural Oak

##### (3) Uni Colours



Black structure

##### (3) Rustic



Golden Craft Oak

##### (4) Uni colours



Cashmere Sandy Grey Dusty Grey

#### FOR DIY PAINTING:

##### (1) Prime



Veneer

##### (2) Uni Colours



White Cashmere Grey Fjord Olive Black

# Side Panels

## Side Panels

Side panels are available as passive door leaves in double doors.

- They are available in rebated and non-rebated options.



Rebated



Non-rebated

## Frame and panel side panels

- Available in natural veneer in size '40'.

## Flush side panels

Flush side panels are available without milling, decorative inlays, glazing, or embossing. The edges are finished with lipping in the colour of the side panel.

- Available in sizes '30', '40', '50'.



## Frame and panel side panels in natural veneer



CODROBA large muntin, side panel model K



CODROBA solid, side panel model A



SEVILLA with glass pane, side panel model I



SEVILLA solid, side panel model J

## Finishes

See larger visualisations [➤ 252](#)

Natural Veneer Oak

Natural Oak Satin Veneer

Option available for collections:

PORTA RESIST  
PORTA FOCUS  
PORTA NOVA  
PORTA FIT  
PORTA LINE  
PORTA CPL  
PORTA DECOR

## Flush side panels



PORTA RESIST model 1.1, flush side panel

### Additionally

hollow chipboard core

PRIME hinges (applies to dedicated door frames)

## Finishes

See larger visualisations [➤ 252](#)

(1) Synthetic Veneer

(2) Synthetic Veneer/  
Soft CPL

(3) Laminate CPL 0.2

(4) Laminate CPL 0.7

## Door ventilation ensures free air flow between rooms separated by doors.

We recommend ventilation especially for bathrooms, because most of them do not have access to a window, and in such a case ventilation is mandatory and specified in the building law - the total area of ventilation openings in accordance with PN-B-03430:1983 (PN-83/B-03430) should be at least 220 cm<sup>2</sup>. Door with a width of '80' meets this requirement.



PORTA VECTOR PREMIUM



PORTA VECTOR PREMIUM  
with recuperation shortcut



PORTA VECTOR PREMIUM  
with ventilation undercut



with recuperation shortcut



with ventilation undercut

Recuperation shortcut option is available in the following collections:

PORTA VECTOR PREMIUM  
PORTA ART DECO  
PORTA HIDE  
PORTA OSLO  
PORTA DESIRE  
PORTA FACTOR

PORTA FOCUS PREMIUM  
PORTA ROYAL  
LONDON  
VIENNA  
WATER  
EARTH

AIR  
NATURE CLASSIC  
NATURE LINE  
NATURE OSLO  
NATURE VECTOR

### Types of ventilation

#### ventilation undercut

- This is a specially cut-out section in the lower part of the door leaf in the shape of a trapezoid – it allows air to flow freely between rooms, ensuring proper circulation.
- The ventilation undercut in the PORTA range is protected with a colourless AQUA STOP varnish made using technoPORTA technology, which protects the door leaf from humidity.
- The height of the ventilation undercut is 36 mm (add 8-12 mm for the installation gap, i.e., the distance between the lower meeting edge type of the leaf and the ground).

#### Recuperation shortcut

- This is a special cutout in the lower part of the door leaf, allowing air to flow freely. It is ideal for energy-efficient buildings, as it enables efficient use of heat. With natural ventilation or traditional ventilation systems, heat would escape outside.
- Before using a recuperation shortcut, make sure you can use it in the room you are designing.
- This is a good alternative to ventilation undercut – we recommend it to those who want the most minimalist ventilation solution possible.
- The height of the recuperation shortcut is 15 mm (add 8-12 mm for the installation gap, i.e., the distance from the lower edge type of the door leaf to the ground).
- Available only for the Polish norm.

Do you have an idea for your doors and a coherent interior?

# Unleash your imagination!



See what we can do for you.



Bespoke colour of a door or two-colour doors.



Coloured rebate



Did you like any of these solutions?

Want to learn more?  
Ask the seller for details.

Wall paneling and built-in furniture



High doors and doors in non-standard widths

Style and durability that  
makes you feel safe



PORTA STEEL SECURE apartment entrance door, Black Structure, and PORTA HIDE 1.1 interior door, Primer with colour applied

# Apartment entrance doors

Are you looking for an entrance door for your apartment that matches the interior? Discover our collections and choose something for yourself.

## Basic



SOLID - vertical graining

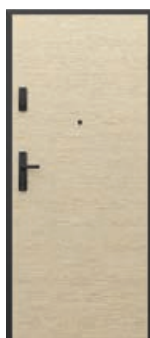

SOLID - horizontal graining

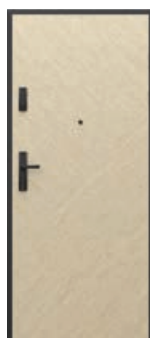

SOLID - geometric graining

## Classic



R.1



R.2

## Insert



J.0

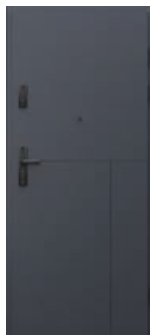

J.2



J.3



J.5

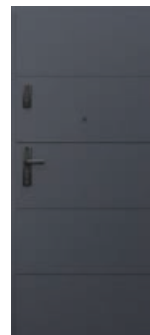

J.6



J.9

## Panel



P.1



P.2



P.3

More in Entrance and Function door catalogue or from the retailer.



PORTA  
KLIMA III

# Entrance and interiors in a consistent style

Are you looking for an entrance door that blends harmoniously with the interior and style of your space? Discover sets that are perfectly matched to each other and to the character of your interior.



EXTREME RC 3  
MODEL J.5



PORTA LINE I.1



EXTREME RC 3 FLAT  
geometric graining



EARTH Z.1



EXTREME RC 3  
MODEL R.1



AIR P.2

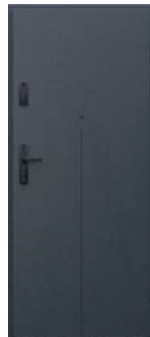

EXTREME RC 3  
MODEL J.9



PORTA LINE H.1

## Matching entrance doors

### handle-handle



Gardo



Gardo Top



Gardo Oval Top



Gardo Oval Top

Finishes

See larger visualisations [➔](#) 252

**(3) Uni Colours**

White Structure   Grey Euroinvest Structure   Anthracite Structure   Black Structure\*

**(3) Modern**

Vicenza Oak   Grey Vicenza Oak   Oak Bookmatch

**(3) Rustic**

Golden Craft Oak

**(3) Traditional**

Light Lakeland Acacia   Lorenzo Oak\*   Natural Kendal Oak   Natural Hickory\*   Natural Oak   Natural Walnut

**(4) Uni colours**

Cashmere   Sandy Grey   Dusty Grey

**(4) Modern**

White Casella Oak   Natural Casella Oak   Brown Casella Oak   Casella Marone Oak

**(4) Rustic**

Halifax Natural   Halifax Tabak   Sherman Oak

**Natural Veneer**

Matte Oak   Oak 1   Ash   Walnut

**Natural Veneer Select Matte**

Oak Bianco   Oak   Taupe Walnut   Dark Walnut

**Natural Oak Satin Veneer**

Light Oak   Winchester Oak   Tabacco   Brown Oak   Mocca

**Natural veneer Uni**

White Oak   Black

**PLEASE NOTE!** Detailed finishes charts in the Entrance and Function doors catalogue.

Parameters

**Burglary resistance**  
RC 2 class, RC 3 class, RC 4 class, C class – door resistance to unauthorized opening.

**Fire resistance**  
EI 30, EI 60 – ability to stop the spread of fire, 30 and 60 minutes, respectively.

**Acoustic insulation**  
Rw=27dB D<sub>25</sub>, Rw=32dB D<sub>30</sub>, Rw=37dB D<sub>35</sub>, Rw=42 dB D<sub>35</sub>, Rw=42 dB D<sub>40</sub> the value indicates the number of decibels that the door is able to dampen.

		BURGLARY RESISTANCE				FIRE RESISTANCE		ACOUSTIC INSULATION		Door leaf thickness [mm]
		RC 2	RC 3	kl. C	RC 4	EI 30	EI 60	32 dB D <sub>30</sub>	37 dB D <sub>35</sub>	
AGATE	door leaf	☐	☐	☐	☐	☐	☐	■	☐	40-41
OPAL	+ door frame	■	☐	☐	☐	☐	☐	■	☐	40-41
EXTREME RC2	+ threshold	■	☐	☐	☐	■*	☐	☐	■	50-51
Steel SECURE		☐	■	☐	☐	■	☐	☐	■	54
EXTREME RC3 EI30	door leaf	☐	■	☐	☐	■*	☐	☐	■	50-51
➔ NEW	+ door frame	☐	■	☐	☐	☐	■	☐	■	61
EXTREME RC3 EI60	+ threshold	☐	■	☐	☐	☐	■	☐	■	61
EXTREME RC4	+ door handle	☐	☐	☐	■	■*	☐	☐	■	54
EXTREME RC4	+ cylinder	☐	☐	☐	■	■*	☐	☐	■	54
GRANITE class C		☐	☐	■	☐	■*	☐	■	☐	48-49

\* optionally at extra charge

Durability  
you can rely on



PORTA CPL with garage package, White Structure, Eleganto handle

# Are you looking for a doorto the garage?

Discover our collections and choose something for yourself.

## 1. Matching the interior



AIR



WATER



PORTA HIDE

Additionally, you can choose PORTA HIDE doors with reinforcement and a threshold 'drop' seal. The door leaf contains two straightening rods so that it maintains its proper plane and does not bend. The rods can be adjusted from the top and bottom.

### Garage door package

Construction consists of a layer of aluminium sheet, chipboard core and automatic threshold 'drop' seal. Thanks to this, we have achieved resistance to the adverse effects of temperature differences and air humidity typical of the transition between the garage and the house.

Package available for collections\*:

AIR	PORTA VIGO	PORTA DESIRE
FIRE	PORTA LINE	PORTA HIDE
WATER	PORTA CPL	PORTA FACTOR
PORTA RESIST	PORTA DECOR	NATURE CLASSIC
PORTA LOFT	PORTA VECTOR	NATURE VERDINO
PORTA LEVEL	PORTA ART DECO	EARTH
PORTA LEVEL LINE	PORTA OSLO	NATURE LINE

\* Garage package not available in Soft CPL and synthetic. veneers from g 1 : UNI and Catania Oak

## 2. Reinforced



AGATE DOOR

AGAT reinforced doors with threshold 'drop' seal ensure tightness and resistance to adverse temperature differences. A strong steel door frame and bolt locks guarantee durability and reliable use.

## 3. Economical



STEEL BASIC,  
STEEL SOLID

Steel BASIC and Steel SOLID doors are a practical, economical solution. Made of durable galvanized steel sheet resistant to corrosion and with the option of using a core of expanded polystyrene or mineral wool, which provides better thermal and acoustic insulation.

For more information, see the Entrance and Function Doors Catalogue or contact your dealer.

# Total customization and perfect results



Entrance door: PORTA THERMO L.6, Beige Gray RAL 7044, square door pull + Solo Solid handle, transom  
Matching interior doors: PORTA VECTOR Premium T, Cashmere, Lago handle

# Exterior steel doors

Match all the doors in your home with colour! Thanks to classic wood-effect laminates and the new palette of paints from the Premium 2025/2026 collection, you will achieve an effect of harmony and elegance in your interiors.

## You can adjust the door dimension

Discover the comprehensive possibilities of PORTA THERMO – made to measure doors. Height and width adjustments every 10 mm allow you to adapt the door to the requirements of the facility, architectural design or lifestyle.

### Dimensional adjustment:

- Width – every 10 mm.
- Height above the standard – every 10 mm.
- Below standard heights – up to 70 mm lower doors. Downsizing every 10 mm.

### Width

Available every 10 mm in the range '80'-'100'.

### The available Sz range:

- STANDARD package: 930–1130 mm.
- OPTIMUM, OPTIMUM ENERGY, PREMIUM ENERGY packages: 954–1154 mm.



S<sub>z</sub>

### Height

Available in every 10 mm from standard height up to a maximum of 300 mm higher.

### Available Hz range:

- STANDARD package: 2010–2380 mm.
- OPTIMUM, OPTIMUM ENERGY, PREMIUM ENERGY package: 2015–2385 mm.



H<sub>z</sub>



MODERN

Check [➤ 244](#)



PANEL GLASS

Check [➤ 245](#)



LINE

Check [➤ 244](#)



RETRO

Check [➤ 246](#)



GLASS

Check [➤ 246](#)



CLASSIC

Check [➤ 247](#)

# PORTA THERMO EXTERIOR STEEL DOORS

The base price of the model includes

DOORS: finished with laminated steel sheet (door leaf width '80' – '100' + door frame with threshold), equipped with a multipoint lock with hooks, adjustable strike plates, dog bolts, and adjustable 3D hinges with caps.

SILVER ACCESSORIES (Inox): Gardo handle with upper escutcheon, set of class B inserts (model M.3 with pull handle – door handle not available).

## Modern



M.1 Anthracite



M.2 Anthracite, single-sided panel



M.3 Anthracite, single-sided panel



M.4 Anthracite, double-sided panels

## Line



L.1 Grey RAL7042\*, double-sided embossing



L.2 Grey RAL7042\*, double-sided embossing



L.3 Grey RAL7042\*, double-sided embossing



L.4 Grey RAL7042\*, double-sided decorative inlays

\* Premium 2025 / 2026 paint colour collection not available in the PREMIUM ENERGY package

**Panel Glass**



P.1 Woodec Turner Oak,  
double-sided embossing



P.2 Woodec Turner Oak



P.3 Woodec Turner Oak



P.4 Woodec Turner Oak



P.5 Woodec Turner Oak



L.5 Grey RAL7042\*,  
double-sided embossing



L.6 Grey RAL7042\*,  
double-sided embossing

**Please note**



**PANEL GLASS**

The glass panel is reinforced around the perimeter with thermosetting paint, which increases resistance to mechanical damage and also reduces the risk of glass cracks due to weather conditions.

RC2 class in OPTIMUM, OPTIMUM ENERGY, PREMIUM ENERGY packages: • at no extra charge - all MODERN models, LINE, C.1, C.2 CLASSIC models and R.1, R.2, R.3, R.4 RETRO models • with extra charge of 340 | 418.20 - all GLASS and PANEL GLASS models • not available in models: C.3, C.4 CLASSIC and R.5, R.6 RETRO

Detailed offer is also available on [www.portadoors.com](http://www.portadoors.com)

# PORTA THERMO EXTERIOR STEEL DOORS

The base price of the model includes

DOORS: finished with laminated steel sheet (door leaf width '80' – '100' + door frame with threshold), equipped with a multipoint lock with hooks, adjustable strike plates, dog bolts, and adjustable 3D hinges with caps.

SILVER ACCESSORIES (Inox): Gardo handle with upper escutcheon, set of class B inserts (model M.3 with pull handle – door handle not available).

## Retro



R.1 Olive grey RAL 7033\*, double-sided mouldings



R.2 Olive grey RAL 7033\*, double-sided mouldings



R.3 Olive grey RAL 7033\*, double-sided fmouldings



R.4 Olive grey RAL 7033\*, double-sided mouldings

## Glass



G.1 Woodec Turner Oak, panels and double-sided embossing



G.2 Woodec Turner Oak, double-sided panels



G.3 Woodec Turner Oak, double-sided panels



G.4 Woodec Turner Oak, double-sided panels



R.5 Olive grey RAL 7033\*,  
double-sided mouldings



R.6 Olive grey RAL 7033\*,  
double-sided mouldings

**Classic**



C.1 Black,  
double-sided mouldings



C.2 Black,  
double-sided mouldings



G.5 Woodec Turner Oak,  
double-sided panels



G.6 Woodec Turner Oak,  
double-sided panels



C.3 Black,  
double-sided glazing beads



C.4 Black,  
double-sided glazing beads



PORTA THERMO R3, Olive Grey RAL 7033, Apollo handle, side transom

## Finishes

See larger visualisations [➔](#) 252

### Premium paints



Models C.3 and C.4 are not available in Premium Paint colours.

### Laminated Steel Sheet

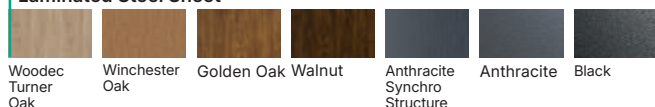

Scan the QR code and go to configurator



## All accessories and details available in following colours

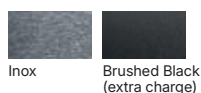

## Additionally

### STANDARD

Electric strike with day/night roller function for configurations: handle + door pull / handle + doorknob

reed switch for all opening methods

silver or black door viewer

arm door closer with block function, silver colour

arm door closer with block function black colour

reinforcement for a door closer

higher doors (every 10 mm within the range Hz = 2015-2385 mm)

wider doors (every 10 mm within the range Sz = 954-1154 mm)

lower doors (every 10 mm within the range Hz = 2015-2085 mm)

colours Premium paints: RETRO door, transoms

colours Premium paints: other collections

### OPTIMUM, OPTIMUM ENERGY, PREMIUM ENERGY

Electric strike with day/night roller function for configurations: handle + door pull / handle + doorknob

electric strike with roller function + reed switch, for the solutions: handle + door pull / handle + knob

reed switch for all opening methods

SMART (biometric fingerprint reader ekey dLine, lock with automatic locking Winkhaus EAV4, power supply), dedicated to solutions: pull without push button\*\*

24 V POWER SUPPLY Dedicated to solutions: door pull with push button

panoramic door viewer, silver

panoramic door viewer, black

arm door closer with block function, silver colour

arm door closer with block function black colour

slide rail door closer with block function, silver colour

slide rail door closer with block function, black colour

concealed door closer (OPTIMUM, OPTIMUM ENERGY)

reinforcement for a door closer

higher doors (every 10 mm within the range Hz = 2015-2385 mm)

wider doors (every 10 mm within the range Sz = 954-1154 mm)

lower doors (every 10 mm within the range Hz = 2015-2085 mm)

colours Premium paints: RETRO door, transoms

colours Premium paints: other collections

\*\* Option available in OPTIMUM ENERGY and PREMIUM ENERGY packages.

# Customize to your needs

Check out the available packages

THE MOST ENERGY SAVING

STANDARD	OPTIMUM	OPTIMUM ENERGY	PREMIUM ENERGY
<b>Ud=1,1</b> thermal insulation [W/m²K]	<b>Ud=0,73</b> thermal insulation [W/m²K]	<b>Ud=0,61</b> thermal insulation [W/m²K]	<b>Ud=0,57</b> thermal insulation [W/m²K]
for glazed doors Ud = 1,2 W/m²K	for glazed doors Ud = 0,81 W/m²K	for glazed doors Ud = 0,69 W/m²K	for glazed doors Ud = 0,65 W/m²K
			
door leaf construction door leaf cladding: galvanized steel sheet coated with PVC veneer. <b>wooden frame</b> + PUR foam infill	door leaf construction door leaf cladding: galvanized steel sheet coated with PVC veneer. <b>composite frame</b> + PUR foam infill	door leaf construction door leaf cladding coating made of galvanized steel sheet covered with PVC veneer <b>composite frame</b> + PUR foam infill	door leaf construction door leaf cladding coating made of galvanized steel sheet covered with PVC veneer <b>composite frame</b> + PUR foam infill
3 rebates 3 anti-burglary dog bolts	4 rebates 6 anti-burglary dog bolts	4 rebates 6 anti-burglary dog bolts	4 rebates 6 anti-burglary dog bolts
<b>thickness</b> <b>54 mm</b>	<b>thickness</b> <b>66 mm</b>	<b>thickness</b> <b>78 mm</b>	<b>thickness</b> <b>66 mm</b>
steel door frame	aluminum door frame	aluminum door frame	composite door frame
-	option to add transoms	option to add transoms	-
steel threshold	aluminum-composite threshold enhancing thermal insulation	aluminum-composite threshold enhancing thermal insulation	aluminum-composite threshold enhancing thermal insulation
standard handle	premium handle with enhanced security parameters RC2	premium handle with enhanced security parameters RC2	premium handle with enhanced security parameters RC2

## Transoms

Transoms are available with aluminum door frames (OPTIMUM and OPTIMUM ENERGY packages). Each side transom can be installed either on the left or right side of the door – they are reversible in direction.

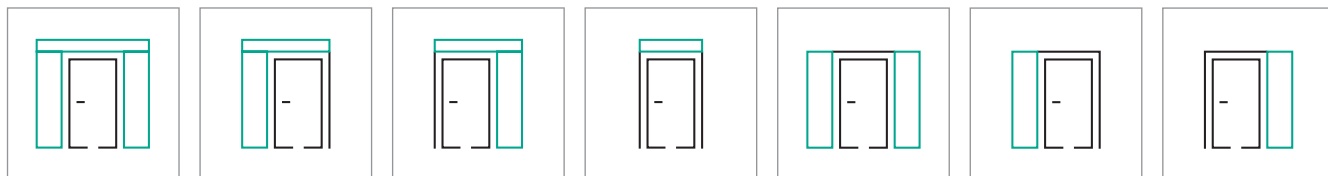

## Available glass panels

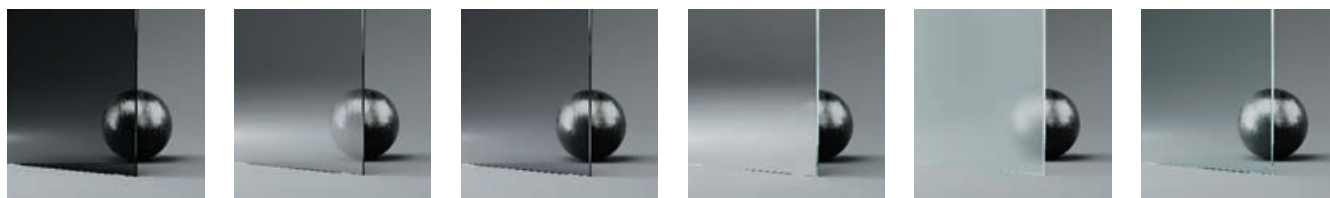

BLACK\*

REFLEX GRAPHITE\*

GRAPHITE

ONE-WAY MIRROR

FROSTED

TRANSPARENT

\* Glazing is not available for the C.4 model. Black glass pane and one-way mirror available at extra charge.

## Handles

### handle-handle



Gardo



Gardo Top



Gardo Oval Top



Gardo Oval Top

### handle-knob



Gardo



Gardo Top



More information and a detailed price list in the PORTA THERMO Exterior Steel Doors catalogue.

Scan QR code and learn more about PORTA THERMO



# Finishes



## Maja Ganszyniec

Product and furniture designer, known for her holistic and responsible approach to design. Her design studio explores how design can combine beauty, functionality, and sustainability. Her clients are IKEA, DUKA, and BMW, among others.



*When I started working with PORTA, we set ourselves a clear goal: to organize the offer so that it was consistent and intuitive to understand. The new system is based on two main criteria – style and price – making the selection process simple and straightforward, and giving the entire range a clear, consistent structure.*

Together with Maja Ganszyniec, we achieved our goal. Transparency and orderliness of the offer have become the foundation of PORTA's new philosophy for the CMF (colour-material-finish) area. The entire process of choosing a door has been designed to facilitate decision-making and support the user at every stage.

The range of finishes is divided into Uni Colours and three distinctly different lines of wood-inspired veneers, allowing them to be quickly matched to the character of the interior:



**Modern** – elegant wood-effect veneers with a calm pattern and even dyeing.



**Traditional** – natural look veneers with a distinct pattern, small knots, and subtle contrast,



**Rustic** – distinctive, rustic veneers with rich graining and visible colour variations.

We have also introduced clear price brackets that allows you to compare available finishes – paint, synthetic veneer and natural veneer. This makes it easy to find an option that harmoniously combines visual qualities with your budget.

PORTA's new approach follows the idea of understandable and functional design – it creates a system that not only organizes the offer, but also inspires.



**P**  
PORTA

# Uni Colour

Scan QR code  
and discover  
our colours



Subdued, uniform, and calm colours. It provides a neutral base; doors with this finish do not attract attention but blend harmoniously into the interior.

Uni Colours can be used in any interior; they are timeless and versatile. They go well with various materials, such as wood, stone, or metal.



## Increased durability

Premium UV Paint \  
Premium Lacquered Veneer

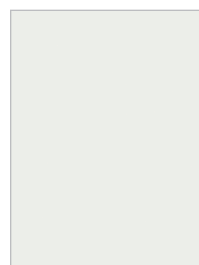

White - UBI  
similar to RAL 9003  
/ NCS S 0500-N

## High durability

Premium Plus  
UV Paint

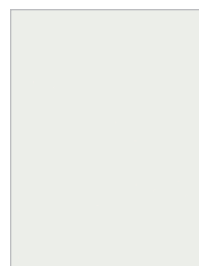

White - WBI  
similar to RAL 9003  
/ NCS S 0500-N



Cashmere - WCA  
similar to  
NCS S2002-Y50R

## Legend of icons



UV



Satin-smooth surface



Antifinger



Certified CPL



Waterproof



Matte finish

Basic durability

(1) Group

Paint/ UV Paint

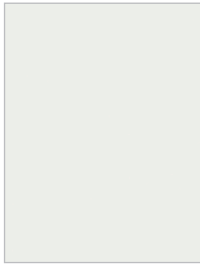

White - LBI / OBI  
similar to RAL 9003  
/ NCS S 0500-N

Synthetic Veneer

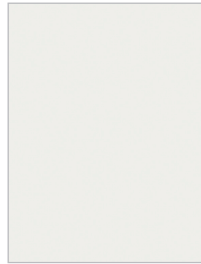

White - DBI  
similar to RAL 9003  
/ NCS S 0500-N

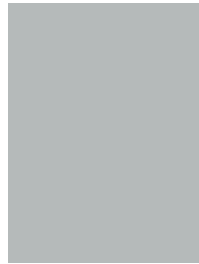

Grey - DSA  
similar to  
NCS S 2500-N



Fjord - DRF  
similar to  
NCS S 4010-B50G



Olive - DOL  
similar to  
NCS S 6005-G20Y

Increased durability

(2) Group

Soft CPL

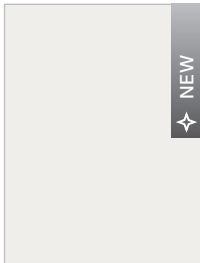

White - SBI  
similar to RAL 9003  
/ NCS S 0500-N

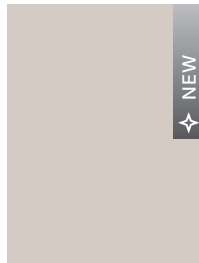

Cashmere - SCA similar to  
NCS S 2502-Y20R\*  
| S 2002-Y50R\*



Grey - SSA  
similar to  
NCS S 2500-N



Fjord - SRF  
similar to  
NCS S 4010-B50G



Olive - SOL  
similar to  
NCS S 6005-G20Y



Black - SCM  
similar to RAL 9005  
| 9004 / NCS 9000-N

High durability

(3) Group

Premium Plus  
UV Paint

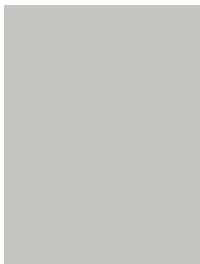

Grey - WSA  
similar to RAL 7035  
/ NCS S 2002-G

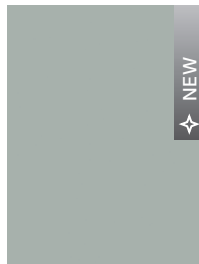

Sage - WSL  
similar to  
NCS S 3005-G20Y

CPL laminate

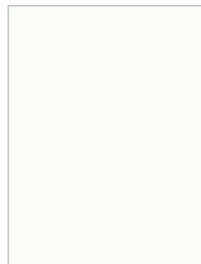

White Structure - 2BM  
similar to RAL 9003  
/ NCS S 0500-N

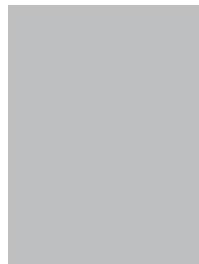

Grey Euroinvest Structure -  
2PO similar to RAL 7047\*  
/ NCS S 2000-N



Anthracite Structure - 2NC  
similar to RAL 7043\*  
| 7016\* / NCS S7500-N



Black Structure\* - 2EC  
similar to RAL 9005  
| 9004 / NCS S 8500-N

High durability

(4) Group

CPL Matte Laminate

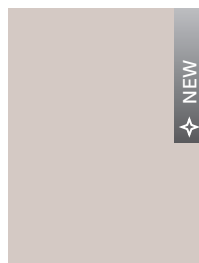

Cashmere - 2CA  
EGGER U702 PM  
similar to  
NCS S 2005-Y60R



Sandt Grey - 2SF  
EGGER U745 PM  
similar to  
NCS S 4502-Y50R



Dusty Grey - 2SE  
EGGER U732 PM similar  
to RAL 7037\*  
/ NCS S 5000-N

\* Conditionally similar

The RAL and NCS equivalents provided may differ slightly from the samples. This is especially applies to dark colours, where different gloss parameters can significantly change the colour perception. We recommend to compare it to the actual sample.

Due to technology and use of various materials for door frames and door leaves, there might appear slight difference between them.

# Modern

Elegant, natural wood with a regular, linear graining (striped and semi-fladder). It is characterized by even dyeing and the absence of knots.

Modern interiors: new buildings, contemporary housing estates in the city, and new modernist houses.



CALM GRAINING (STRIPED AND HALF-FLADDER)

NO KNOTS

EVEN DYEING

## Legend of icons



UV



Certified CPL



Natural look



Distinct, deep structure



Waterproof

Increased durability

(2) Group

Synthetic Veneer

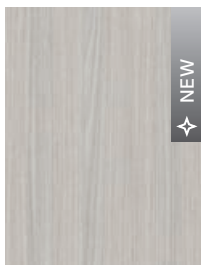

Salvador Whitened Oak - PEE

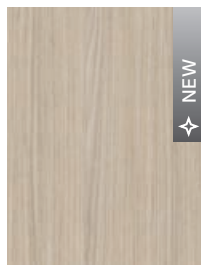

Salvador Light Oak - PEK

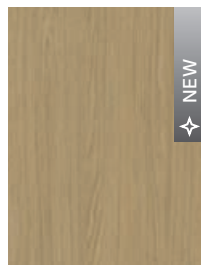

Natural Arles Oak - PER

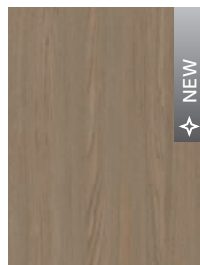

Toffe Arles Oak - PET

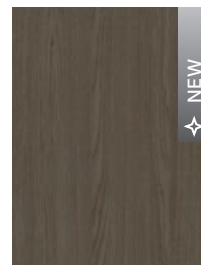

Dark Arles Oak - PEX



Havana Oak - PDH

High durability

(3) Group

CPL laminate

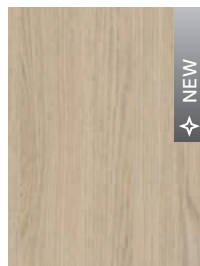

Vicenza Oak - 2GT / 7GT



Vicenza Grey Oak - 2GS / 7GS

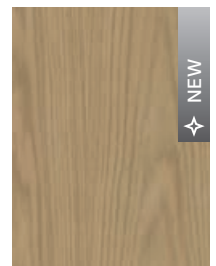

Bookmatch Oak - 2DW / 7DW

Highest durability

(4) Group

3mm Synchronous Board

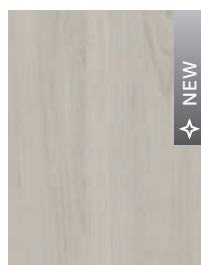

White Casella Oak - TCB



Natural Casella Oak - TCN

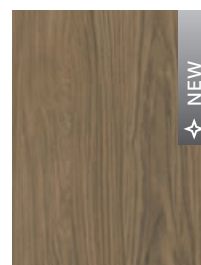

Brown Casella Oak - TCR



Casella Marone Oak - TCE

# Traditional

Natural wood with a beautifully highlighted structure: distinctive graining (fladder), small knots, and naturally uneven dyeing.

Warm, family-friendly interiors: houses and apartments in new and old buildings, contemporary holiday homes.

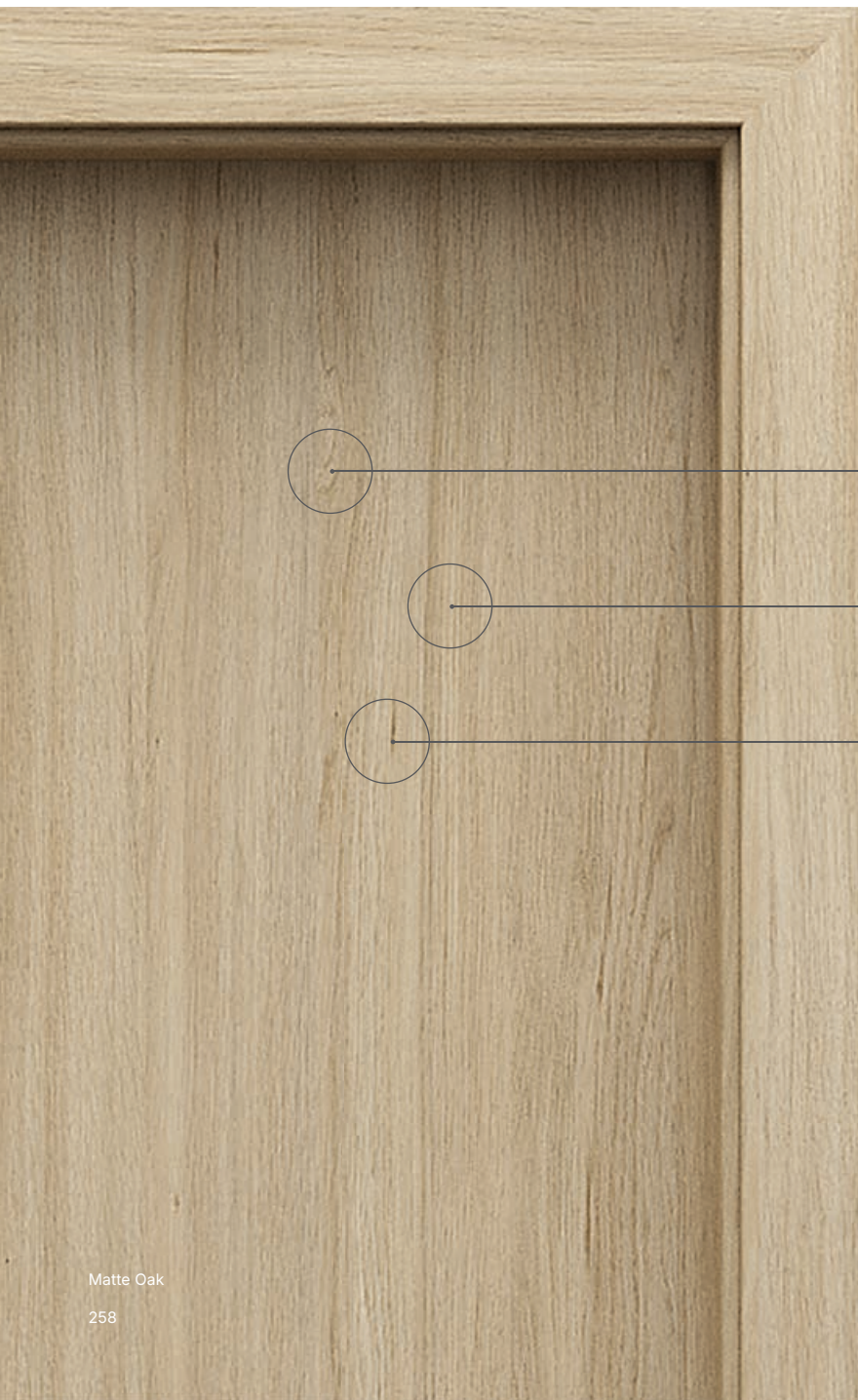

**DISTINCTIVE GRAINING (FLADDER)**



**UNEVEN DYEING**



**SMALL KNOTS**

## Legend of icons



UV



Certified CPL



Natural look



Replicates wood graining



Waterproof

Basic durability

(1) Group

Synthetic Veneer



Andersen Pine  
- RSD

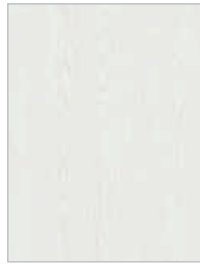

Wenge White  
- RNS



Whitened Walnut  
- DOB



Classic Oak  
- PDL



Dark Oak  
- RDC

Increased durability

(2) Group

Synthetic Veneer

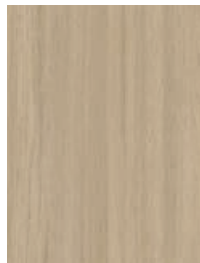

Matte Oak  
- PSM



Natural Oak  
- PDA



California Oak  
- PDK



Dark Matte Oak  
- PLC

High durability

(3) Group

CPL laminate

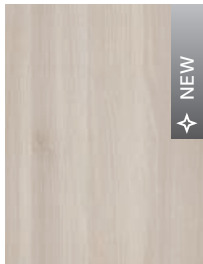

Light Lakeland Acacia  
- 2AL/7AL

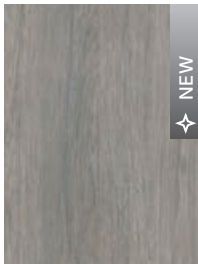

Lorenzo Oak\*  
- 2LR / 7LR

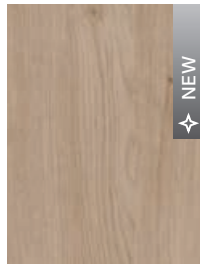

Natural Kendal Oak  
- 2KL/7KL



Natural Hickory\*  
- 2OH / 7OH



Natural Oak  
- 2DA / 7DA



Natural Walnut  
- 2ON / 7ON

Highest durability

Grupa (4)



Sand Oak  
- TDP

# Rustic

Rustic wood with a rich, distinctive graining. The varied graining, contrasting differences in dyeing, and visible filler give it an authentic character. The colour palette is dominated by warm shades of brown.

Rustic interiors: single-family homes, holiday homes, agritourism.



DISTINCTIVE AND PATTERNED  
WOOD GRAINING

KNOTS AND FILLER

VISIBLE DYEING

## Legend of icons



UV



Certified CPL



Natural  
look



Antifinger



Replicates  
wood graining



Distinct,  
deep  
structure



Waterproof

Basic durability

(1) Group

Synthetic Veneer



Norwegian Pine  
- RSN



Silver Acacia  
- RAS



Golden Craft Oak  
- PDB



Mauvella Oak  
- PDM



Catania Oak  
- DDT



Honey Acacia  
- RAM



Scarlet Oak  
- RDS

Increased durability

(2) Group

Synthetic Veneer

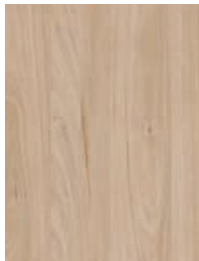

Scandinavian Oak  
-

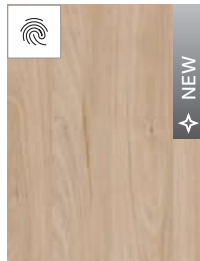

Light Hikora Jackson  
- PHJ



English Oak Hamilton  
- IDQ



Siberian Oak  
-

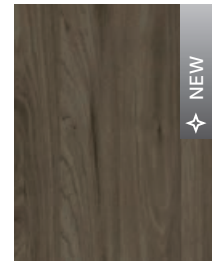

Dark Hikora Jackson  
- PHC

High durability

(3) Group

CPL laminate



Craft Golden Oak  
- 2DB / 7DB

Highest durability

(4) Group

3mm Synchronous Board



Halifax Natural  
- THN



Halifax Tabak  
- THT



Sherman Oak  
- TDF

# NATURAL VENEER

Natural veneer is a thin layer of real wood, each door leaf has a unique grain pattern. No two doors are alike, which adds nobility and authenticity to the interior.

Doors with natural veneer are suitable for both classic and modern interiors with an elegant character.



## Natural Veneer



Matte Oak  
- AD1

Oak 1  
- ND1/KD1

Ash  
- KJ1

Walnut  
- KO1

## Natural Veneer Select Matte



Bianco Oak Matte  
- FLB/BLB

Oak  
- BDX

Walnut Taupe Matte  
- FOT

Dark Walnut  
- FQX

## Natural Veneer Satin Oak



Light Oak  
- NDJ/KDJ

Winchester Oak  
- NDE/KDE

Tabacco  
- NTC / KTC

Brown Oak  
- NDR/KDR

Mocca  
- NMO / KMO

## Natural Veneer UNI

### COLOURS MARKING:

B, M, N – striped veneer

E, F, K – veneer, 'fladder' version

The veneer graining is obtained through the proper selection of wood and the appropriate processing of the veneer leaves and the technique of folding them. Due to the characteristic of natural veneers, differences in colour and graining, might appear on a door leaf.

These differences cannot be grounds for accepting a complaint.

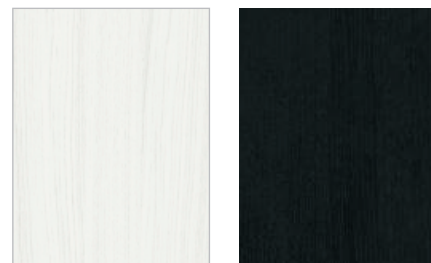

White Oak - NBI / KBI  
similar to RAL 9016

Black - BEC  
similar to RAL 9017

# Powder paints

Powder coating creates a very hard and durable coating. These doors are resistant to scratches, impacts, and heavy use.

The combination of powder paint coated elements with large glazing brightens and visually enlarges the interior. Perfect for apartments and offices.



## Finishes of steel door frames

Polyester

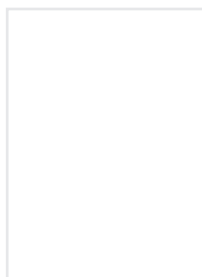

White MATTE - LBM  
similar to RAL 9003

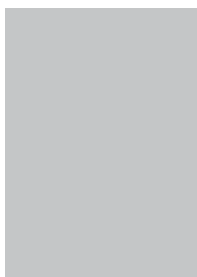

Grey MATTE - LPM  
similar to RAL 7047



Anthracite HPL/CPL -  
LNC\*\* similar to RAL  
7043\*/7016\*

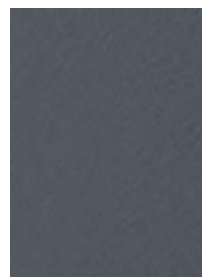

Anthracite Structure -  
LNT similar to  
RAL 7024

\* conditionally similar

Provided RAL analogues may slightly differ from the samples. This is especially applies to dark colours, where different gloss parameters can significantly change the colour perception. We recommend to compare it to the actual sample.

\*\* HPL/CPL marking was introduced considering dedicated veneer Anthracite HPL/CPL



Beige MATTE - LKM  
similar to RAL 1019

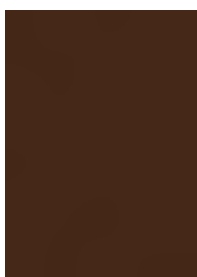

Brown MATTE - LRM  
similar to RAL 8028

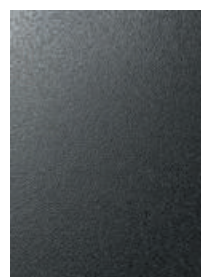

Black Structure - LCS  
similar to RAL 9005



Black MATTE - LCM  
similar to RAL 9017

## Finishes of STEEL PORTA LOFT

Powder Paint

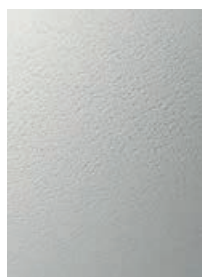

White Structure similar  
to RAL 9003

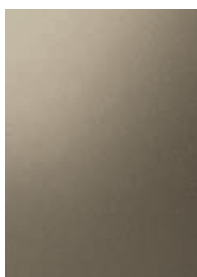

Champagne, similar  
to RAL 1035

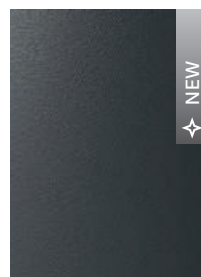

Anthracite Structure  
similar to RAL 7016

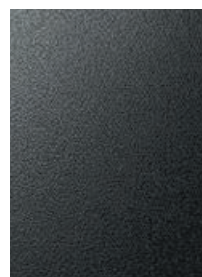

Black structure  
similar to RAL 9005

# Technical drawings

## Retro module (with PORTA SYSTEM door frame)

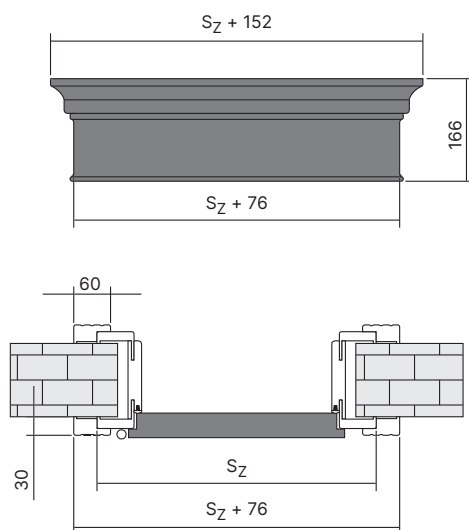
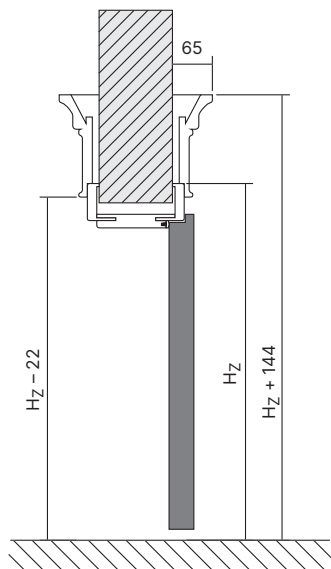
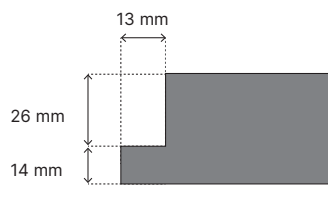

## Preparing the opening for the installation of a steel door frame

**ATTENTION:** in the case of steel door frames, for the dimensions of wall openings given in the tables, it may be necessary to make small spot chisels on the wall edges in places where the internal elements of the door frames protrude.

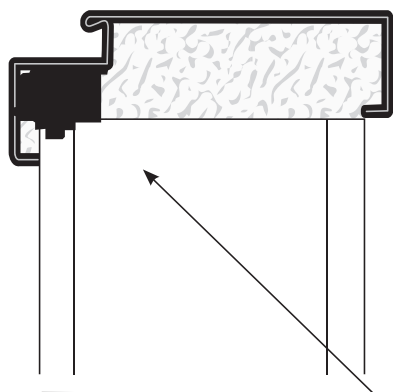

## Preparing the opening for the installation of a non-rebated door frame.

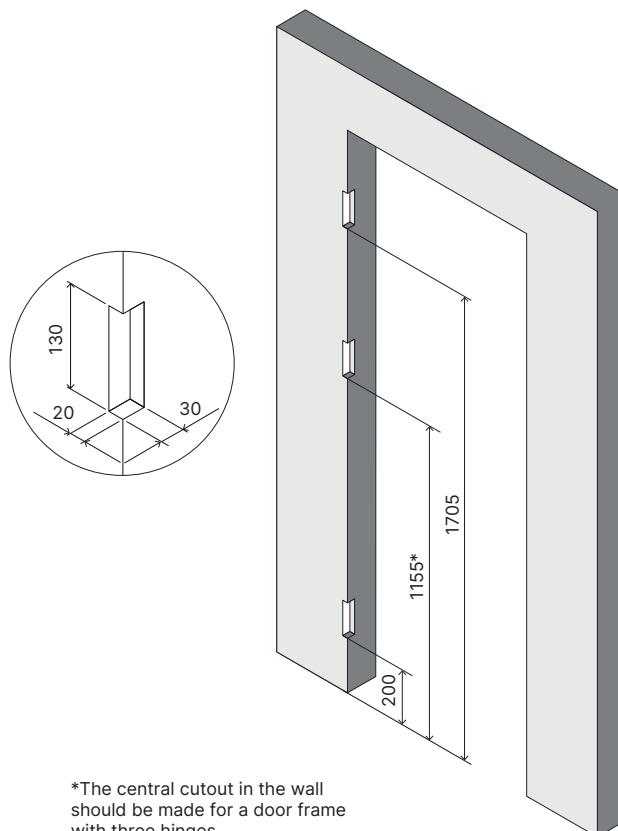

\*The central cutout in the wall should be made for a door frame with three hinges

# Other door dimension tables

If you are looking for technical door dimensions, you will find them in dedicated catalogues (check the inside back cover of the catalogue).

To obtain the  $S_o$  dimension for a double leaf door, you must:

- for rebated door leaves with Porta SYSTEM frame: to the  $S_o$  dimension given in Table 1 for a single (rebated) door leaf, add the  $S_s$  dimension of the second (rebated) door leaf or the side panel (rebated).
- For rebated door leaves with other types of door frames: To the  $S_o$  dimension specified in Table 1 for a single (rebated) door leaf, add the  $S_s$  dimension of the second (rebated) door leaf or the (rebated) side panel, and then subtract 10 mm from the resulting value.
- For non-rebated door leaves: To the  $S_o$  dimension specified in Table 1 for a single (non-rebated) door leaf, add the  $S_s$  dimension of the second (non-rebated) door leaf or the (non-rebated) side panel, increased by 16 mm.

## Enlarging the adjustment range of adjustable door frame with a tunnel.

Door frame type	Adjustment range [mm]	Door frame type	Adjustment range [mm]	Door frame type	Adjustment range [mm]	Door frame type	Adjustment range [mm]	Door frame type	Adjustment range [mm]
D+D	288 - 308	G+F	388 - 408	I+I	488 - 508	K+L****	588 - 608	N+N****	688 - 708
E+D	308- 328	G+G	408 - 428	J+I	508 - 528	L+L****	608 - 628	-	-
E+E	328 - 348	H+G	428 - 448	J+J	528 - 548	M+M****	628 - 648	-	-
F+E	348 - 368	H+H	448 - 468	K+J	548 - 568	M+M****	648 - 668	-	-
F+F	368 - 388	I+H	468 - 488	K+K	568 - 588	M+N****	668 - 688	-	-

## PORTA GLASS door

Door frame type	Size	$S_s$	$H_s$	$D_s$	$S_o$	$H_o$	$O_s$	$O_w$	$S_b$	$H_b$	$S_z$ (6)	$S_z$ (8)	$H_z$	$T_{s/w}$
PORTA SYSTEM	60	618	2016	8	680	2060	602	2016	646	2038	746	786	architrave (6) / (8) 2088 / 2108	+20 / +10
	70	718			780		702		746		846	886		
	80	818			880		802		846		946	986		
	90	918			980		902		946		1046	1086		
Corner profile steel door frame - LARGE (concrete wall)	60	618	2016	8	675	2055	596	2016	656	2046	706	-	2071	±10 / ±5
	70	718			775		696		756		806	-		
	80	818			875		796		856		906	-		
	90	918			975		896		956		1006	-		
Corner profile - LARGE (plasterboard wall)	60	618	2016	8	685	2055	596	2016	680	2046	706	-	2071	±10 / ±5
	70	718			785		696		780		806	-		
	80	818			885		796		880		906	-		
	90	918			985		896		980		1006	-		
Steel Porta SYSTEM	60	618	2016	8	675	2055	596	2016	646	2041	736	-	2086	±10 / ±5
	70	718			775		696		746		836	-		
	80	818			875		796		846		936	-		
	90	918			975		896		946		1036	-		

### Key to dimensions

$S_s$	total width of the door leaf (including the rebates)	$H_b$	door frame height, dimension without architraves
$H_s$	total height of the door leaf (including the rebate)	$S_z$	total door frame width with architraves
$D_s$	door leaf thickness	$H_z$	total height of door frame, including architraves
$S_o$	width of the wall opening prepared for embedding the frame	$M_s$	width of sliding door masking system
$H_o$	height of the wall opening prepared for embedding the frame, measured from the level of the finished floor	$M_o$	thickness of a rail cover (sliding systems)
$O_s$	opening width (for Alfa and Beta this dimension is decreased by the door leaf thickness)	$B_o$	thickness of a door stop (jamb) (sliding systems)
$O_w$	height of the opening after door installation (measured from finished floor level)	$T_{s/w}$	permissible tolerance of deviation in width   height of wall opening
$S_b$	door frame width without architraves	$S_c$	wall opening width for a metal cassette (pocket door system)
		$H_c$	wall opening height for a metal cassette (pocket door system), (measured from finished floor level)

Refer to architrave 60/80 mm in dimension tables ( $S_z$ ).

## STEEL PORTA LOFT DOORS

Door frame type	Size	$S_o$	$H_o$	$S_z/S_b$	$H_z/H_b$
STEEL PORTA LOFT	80	874	2053	864	2048
	90	974		964	

$S_o$	width of the wall opening prepared for embedding the frame
$H_o$	Height of the wall opening prepared for embedding the frame
$S_b$	door frame width without architraves
$H_b$	door frame height, dimension without architraves
$S_z$	total door frame width with architraves
$H_z$	total height of door frame, including architraves

### Notes

- Dimension tolerance according to PN: up to 1 m: ±1 mm, above 1 m: ±2 mm - applies to width and height dimensions.
- Side door panels for rebated door sets are available in Natural veneer in size '40';  $S_s$  =444,  $H_s$  =2030.
- Door frames are designed to be installed on finished floor level. For steel door frames there is a possibility to order them in lengthen option + 30 mm (to be mounted underfloor level). In this case sizes  $H_b$  and  $H_z$  are enlarged by 30 mm (level -30).
- The dimension provided in the table for interior door leaves applies to both rebated and sliding doors.
- PORTA SYSTEM integrated with upper transom, dimension  $H_o$ ,  $H_b$ , and  $H_z$  +302 mm.

# Other door dimension tables

## Apartment entrance doors

Door frame type	Size	S <sub>s</sub>	H <sub>s</sub>	D <sub>s</sub>	S <sub>o</sub>	H <sub>o</sub>	O <sub>s</sub>	O <sub>w</sub>	S <sub>b</sub>	H <sub>b</sub>	S <sub>z</sub> (6)	S <sub>z</sub> (8)	H <sub>z</sub>	T <sub>s/w</sub>
AGATE, OPAL, GRANITE class C with steel door frame**	80	844	2030*	40 / 41 48 / 49	876	2056	796	2016***	856	2046	906	-	2071	±10 / ±5
	90	952			986		904		964		1014	-		
	100	1044			1076		996		1056		1106	-		
EXTREME RC2, EXTREME RC 3 with steel door frame**	80	844	2032	50	876	2056	796	2016***	856	2046	906	-	2071	±10 / ±5
	90	968			1000		920		980		1030	-		
	100	1044			1076		996		1056		1106	-		
EXTREME RC 3 with PS door frame	80	844	2032	50	880	2060	802	2018***	850	2042	-	986	2110	+20 / +10
	90	968			1005		926		974		-	1110		
	100	1044			1080		1002		1050		-	1186		
EXTREME RC 3 EI 60**	80	844	2032	62	880	2060	796	2016***	856	2046	906	-	2071	±10/±5
	90	968			1005		920		980		1030	-		
	100	1044			1080		996		1056		1106	-		
EXTREME RC 4 with steel door frame**	80	844	2032	54	880	2060	798	2016***	858	2046	908	-	2071	±10 / ±5
	90	968			1005		922		982		1032	-		
	100	1044			1080		998		1058		1108	-		
Steel SECURE	80	868	2040	54	900	2065	820	2025	880	2055	930	-	2080	±10 / ±5
	90	968			1000		920		980		1030	-		
	100	1068			1100		1020		1080		1130	-		

\* for GRANIT class CHS=2032

\*\* When using the PROJEKT (BIS and Premium) door frame, the wall opening S<sub>0</sub> should be increased by 30 mm and the height H<sub>0</sub> by 15 mm (tolerance ±10 mm / ±5 mm).

\*\*\* Steel threshold decreases given dimension by 16 mm.

NOTE: in the case of steel door frames, for the dimensions of wall openings given in the tables, it may be necessary to make small spot chisels on the wall edges in places of protruding internal elements of the door frames - see the drawing on page [266](#)

## PORTA THERMO\* exterior entrance doors

Door frame type	Size	S <sub>s</sub>	H <sub>s</sub>	D <sub>s</sub>	S <sub>o</sub>	H <sub>o</sub>	O <sub>s</sub>	O <sub>w</sub>	S <sub>z</sub>	H <sub>z</sub>	T <sub>s/w</sub>
STANDARD PACKAGE	80	868	2040	54	950	2090	820	2008	930	2080	+10 / +5
	85	918			1000		870		980		
	90	968			1050		920		1030		
	95	1018			1100		970		1080		
	100	1068			1150		1020		1130		
OPTIMUM PACKAGE	80	885	2038	66	977	2095	837	2005	957	2085	+10 / +5
	85	935			1027		887		1007		
	90	985			1077		937		1057		
	95	1035			1127		987		1107		
	100	1085			1177		1037		1157		
OPTIMUM ENERGY PACKAGE	80	885	2038	78	977	2095	837	2005	957	2085	+10 / +5
	85	935			1027		887		1007		
	90	985			1077		937		1057		
	95	1035			1127		987		1107		
	100	1085			1177		1037		1157		
PREMIUM ENERGY PACKAGE	80	885	2038	66	977	2095	837	2005	957	2085	+10 / +5
	85	935			1027		887		1007		
	90	985			1077		937		1057		
	95	1035			1127		987		1107		
	100	1085			1177		1037		1157		

\* dimensions for standard height, when the height is changed, the dimensions H<sub>s</sub>, H<sub>o</sub>, O<sub>w</sub>, H<sub>b</sub>, H<sub>z</sub> are adjusted accordingly within the ranges - 70 to +300 mm  
\* Dimensions H<sub>z</sub> and H<sub>o</sub> increase by 3 mm when a concealed door closer is used.

## PORTA THERMO door transoms\*

Door frame type	NH	Now	NS	Nos
SIDE TRANSOMS	2085	1967	300	182
			400	282
			500	382
			600	482
			700	582
			800	682
UPPER TRANSOMS	300 / 400 / 500	182 / 282 / 382	957	839
			1007	889
			1057	939
			1107	989
			1157	1039
			1207	1089
			1257	1139
			1307	1189
			1357	1239
			1407	1289
			1457	1339
			1507	1389
			1557	1439
			1607	1489
			1657	1539
			1707	1589
			1757	1639
			1807	1689
			1857	1739
			1907	1789
			1957	1839
			2007	1889
			2057	1939
			2107	1989
			2157	2039
			2207	2089
			2257	2139
2307	2189			
2357	2239			
2407	2289			
2457	2339			
2507	2389			
2557	2439			
2607	2489			
2657	2539			
2707	2589			
2757	2639			

\* dimensions for standard height, when the door height is changed, the dimensions NH, Now for the side transom are adjusted accordingly NH dimensions, Now increase by 3 mm in the case of a side transom in and doors equipped with a concealed door closer.

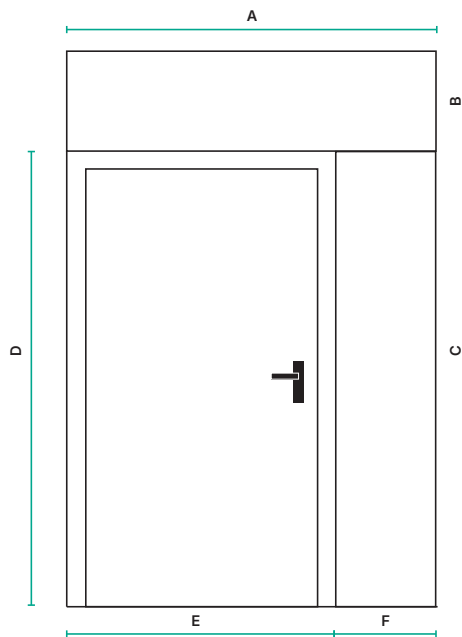

- A** Adjustment of transom width in the range of NS 954 - 2754 mm
- B** Adjustment of transom height within the NH range of 300-500 mm (every 10 mm).
- C** Adjustment of the side transom height within the Hz range of 2015-2385 mm (every 10 mm).
- D** Adjustment of door height - every 10 mm, within the range: standard  $H_z = 2010 - 2380$  mm  
optimum  $H_z = 2015 - 2385$  mm  
premium  $H_z = 2015 - 2385$  mm
- Door width adjustment - every 10 mm, within the range:
- E** Standard  $S_z = 930-1130$  mm  
Optimum  $S_z = 954-1154$  mm  
Premium  $S_z = 954-1154$  mm
- Adjustment of the side transom width within the range
- F** NS 300 - 800 mm (every 10 mm)

## Key to dimensions

- $S_s$  total width of the door leaf (including the rebates)
- $H_s$  total height of the door leaf (including the rebate)
- $D_s$  door leaf thickness
- $S_o$  width of the wall opening prepared for embedding the frame
- $H_o$  height of the wall opening prepared for embedding the frame, measured from the level of the finished floor
- $O_s$  opening width
- $O_w$  height of the opening after door frame installation (measured from finished floor level)
- $S_z$  total door frame width with architraves
- $H_z$  total height of door frame, including architraves
- $T_{sw}$  permissible tolerance of deviation in width | height of wall opening
- NS** total width of the transom
- NH** total height of the transom
- Nos** visible width of glazing
- Now** visible height of glazing

# Other door dimension tables

## INTERIOR DOORS WITH WOODEN DOOR FRAMES

CN/DIN	Size	S <sub>s</sub>	H <sub>s</sub>	D <sub>s</sub>	S <sub>o</sub>	H <sub>o</sub>	O <sub>s</sub>	O <sub>w</sub>	S <sub>B</sub>	H <sub>B</sub>	S <sub>z</sub> (6)	S <sub>z</sub> (8)	H <sub>z</sub>	T <sub>s/w</sub>
with a door frame: Minimax 60 mm Minimax 100 mm	60	648/610	1985	40	715/680	2030	606/569	1971	694/657	2015	804/767	-	2070	±20 / 10
	70	748/735			815/805		706/694		794/782		904/892	-		
	80	848/860			915/930		806/819		894/907		1004/1017	-		
	90	948/985			1015/1055		906/944		994/1032		1104/1142	-		
	100	1048/-			1115/-		1006/-		1094/-		1204/-	-		
with a door frame: PORTA SYSTEM HYDRO PROTECT™	60	648/610	1985	40	685/650	2015	606/567	1971	650/611	1993	750/711	790/751	architrave (6) / (8) 2043/2063	±20 / 10
	70	748/735			785/775		706/692		750/736		850/836	890/876		
	80	848/860			885/900		806/817		850/861		950/961	990/1001		
	90	948/985			985/1025		906/942		950/986		1050/1086	1090/1126		
	100	1048/-			1085/-		1006/-		1050/-		1150/-	1190/-		
with the door frame: PORTA SYSTEM ELEGANCE HYDRO PROTECT™	60	622/584	1972	40	695/660	2015	606/567	1971	650/611	1993	-	790/751	2063	±20 / 10
	70	722/709			795/785		706/692		750/736		-	890/876		
	80	822/834			895/910		806/817		850/861		-	990/1001		
	90	922/959			995/1035		906/942		950/986		-	1090/1126		
	100*	1022/-			1095/-		1006/-		1050/-		-	1190/-		
with a door frame: PORTA SYSTEM with reverse rebate**	60	643	1982	40	725	2035	630	1983	695	2015	-	835	-/2085	±10/±5
	70	743			825		730		795		-	935		
	80	843			925		830		895		-	1035		
	90	943			1025		930		995		-	1135		
	100	1043			1125		1030		1095		-	1235		
with a door frame: RENOVA***	60	648	1985	40	600	1971	562	1949	588	1962	750	-	2043	+15*/-6
	70	748			700		662		688		850	-		
	80	848			800		762		788		950	-		
	90	948			900		862		888		1050	-		
	100	1048			1000		962		988		1150	-		
ALFA system	60	647/609	1955	40	685/650	2015	465/425	1971	650/611	1993	750/711	790/751	architrave (6) / (8) 2043/2063	±20/10
	70	747/734			785/775		565/550		750/736		850/836	890/876		
	80	847/859			885/900		665/675		850/861		950/961	990/1001		
	90	947/985			985/1025		765/800		950/986		1050/1086	1090/1126		
	100	1047/-			1085/-		865/-		1050/-		1150/-	1190/-		
BETA System	60	592/556	1945	40	685/650	2005	455/415	1971	650/611	2004	750/711	790/751	architrave (6) / (8) 2043/2063	±20/10
	70	692/680			785/775		555/540		750/736		850/836	890/876		
	80	792/806			885/900		655/665		850/861		950/961	990/1001		
	90	892/930			985/1025		755/790		950/986		1050/1086	1090/1126		

\*\* Outer dimensions (on the narrower side of the door leaf) SZ and HZ are identical to the dimensions of doors with PORTA SYSTEM ELEGANCE door frames.

\*\*\* S<sub>o</sub> / H<sub>o</sub> width/height of clear opening of old steel frame. TS/W - tolerance +15 mm depends on a construction of the old door frame.

NOTE: The dimensions S<sub>z</sub> and H<sub>z</sub> for frames with natural veneer are provided with a tolerance of -1 mm / +3 mm.

NOTE: For doors with a height of '210', the dimensions: H<sub>s</sub>, H<sub>o</sub>, O<sub>w</sub>, H<sub>B</sub> should be increased by 132 mm.

## INTERIOR DOORS WITH STEEL DOOR FRAMES

CN/DIN	Size	S <sub>s</sub>	H <sub>s</sub>	D <sub>s</sub>	S <sub>o</sub>	H <sub>o</sub>	O <sub>s</sub>	O <sub>w</sub>	S <sub>B</sub>	H <sub>B</sub>	S <sub>z</sub> (6)	S <sub>z</sub> (8)	H <sub>z</sub>	T <sub>s/w</sub>
with Steel PORTA SYSTEM door frame	60	648/610	1985/1985	40	680/640	2010	600/561	1968	650/611	1993	740/701	-	2038	±10/±5
	70	748/735			780/765		700/686		750/736		840/826	-		
	80	848/860			880/890		800/811		850/861		940/951	-		
	90	948/985			980/1015		900/936		950/986		1040/1076	-		
	100	1048/-			1080/-		1000/-		1050/-		1140/-	-		
Steel PORTA SYSTEM ELEGANCE	60	622/584	1972/1972	40	680/640	2010	600/561	1968	650/611	1993	740/701	-	2038	±10 / ±5
	70	722/709			780/765		700/686		750/736		840/826	-		
	80	822/834			880/890		800/811		850/861		940/951	-		
	90	922/959			980/1015		900/936		950/986		1040/1076	-		
	100	1022/-			1080/-		1000/-		1050/-		1140/-	-		

\*\* If the hinge receiver does not fit within the wall opening, it is required to do some chiselling as shown on the picture.

## SLIDING SYSTEMS

CN	Size	S <sub>s</sub>	H <sub>s</sub>	D <sub>s</sub>	S <sub>0</sub>	H <sub>0</sub>	O <sub>s</sub>	O <sub>w</sub>	H <sub>z</sub>	M <sub>s</sub> (6), (8)	M <sub>0</sub>	B <sub>0</sub>	T <sub>s/w</sub>
PORTA sliding system	60	644	1985	40	684	2015	606	1971	2074	1413	103	60	±20/10
	70	744			744		784			706			
	80	844			884		806			1813			
	90	944			984		906			2013			
	100	1044			1084		1006			2213			

CN	Size	S <sub>s</sub>	H <sub>s</sub>	D <sub>s</sub>	S <sub>0</sub>	H <sub>0</sub>	O <sub>s</sub>	O <sub>w</sub>	S <sub>B</sub>	H <sub>B</sub>	SZ <sub>(6)</sub>	SZ <sub>(8)</sub>	H <sub>Z(6),(8)</sub>	S <sub>C</sub>	H <sub>C</sub>	T <sub>s/w</sub>
COMPACT sliding system – single	60	644	1985	40	660	2020	600	1973	654	1995	744	784	2045 / 2065	1355	2085	±10/5
	70	744			760		700		754		844	884		1555		
	80	844			860		800		854		944	984		1755		
	90	644			960		900		954		1044	1084		1955		
	100	1044			1060		1000		1054		1144	1184		2155		
COMPACT sliding system – double	2×60	2×644	1985	40	1300	2020	1249	1973	1293	1995	1393	1433	2045 / 2065	2845	2085	±10/5
	2×70	2×744			1500		1449		1493		1593	1633		1633		
	2×80	2×844			1700		1649		1693		1793	1833		1833		
	2×90	2×644			1900		1849		1893		1993	2033		3845		
	2×100	2×1044			2100		2049		2093		2193	2233		4245		

CN	Size	S <sub>s</sub>	H <sub>s</sub>	D <sub>s</sub>	S <sub>0</sub>	H <sub>0</sub>	O <sub>s</sub>	O <sub>w</sub>	S <sub>B</sub>	H <sub>B</sub>	S <sub>Z</sub>	H <sub>Z</sub>	S <sub>C</sub>	H <sub>C</sub>	T <sub>s/w</sub>
Frameless system	70	744	1985	40	1580	2070	726	1991	823	2022	1560	2056	1580	2070	±20/10
	80	844			1780		826		923		1760		1780		
	90	944			1980		926		1023		1960		1980		

CN	Size	S <sub>s</sub>	H <sub>s</sub>	D <sub>s</sub>	S <sub>0</sub>	H <sub>0</sub>	M <sub>s</sub>	T <sub>s/w</sub>
SLIDE sliding system	70	744	2155	40	680	2015	2000	±10/5
	80	844			780			
	90	944			880			
	100	1044			980			
BLACK sliding system	70	744	2045	40	680	2015	2000	±10/5
	80	844			780			
	90	944			880			
	100	1044			980			

CN	SIZE	S <sub>s1</sub>	S <sub>s2</sub>	H <sub>s</sub>	D <sub>s</sub>	S <sub>0</sub>	H <sub>0</sub>	M <sub>s</sub>	T <sub>s/w</sub>
BLACK double sliding system	70 + 70	744	744	2045	40	1425	2015	4000	±10/5
	80 + 70	844	744			1525			
	80 + 80	844	844			1625			
	90 + 70	944	744			1625			
	90 + 80	944	844			1725			
	90 + 90	944	944			1825			
	100 + 70	1044	744			1725			
	100 + 80	1044	844			1825			
	100 + 90	1044	944			1925			
	100 + 100	1044	1044			2025			

# Other door dimension tables

## PORTA GLASS DOORS

CN	Size	S <sub>s</sub>	H <sub>s</sub>	D <sub>s</sub>	S <sub>o</sub>	H <sub>o</sub>	O <sub>s</sub>	O <sub>w</sub>	S <sub>b</sub>	H <sub>b</sub>	SZ (6)	SZ (8)	HZ	TS W
PORTA SYSTEM	70	721	1971	8	785	2015	706	1971	750	1993	850	890	architrave (6) / (8) 2043/2063	±20 / 10
	80	821			885		806		850		950	990		
	90	921			985		906		950		1050	1090		
Corner profile steel door frame - LARGE (concrete wall)	70	721	1971	8	780	2010	700	1968	760	1998	810	-	2023	±10 / ±5
	80	821			880		800		860		910	-		
	90	921			980		900		960		1010	-		
Corner profile - LARGE (plasterboard wall)	70	721	1971	8	785	2010	700	1968	784	1998	810	-	2023	±10 / ±5
	80	821			885		800		884		910	-		
	90	921			985		900		984		1010	-		
Steel Porta SYSTEM	70	721	1971	8	785	2010	700	1968	784	1998	810	-	2023	±10 / ±5
	80	821			885		800		884		910	-		
	90	921			985		900		984		1010	-		

## PORTA HIDE DOORS

CN	Size	S <sub>s</sub>	H <sub>s</sub>	D <sub>s</sub>	S <sub>o</sub>	H <sub>o</sub>	O <sub>w</sub>	O <sub>w</sub>	S <sub>b</sub>	H <sub>b</sub>
PORTA HIDE non-rebated (outward opening)	70	722	1972	40	800	2025	707	1972	791	2014
	80	822			900		807		891	
	90	922			1000		907		991	
PORTA HIDE with reverse rebate (inward opening)	70	722	1982	40	800	2035	707	1982	791	2024
	80	822			900		807		891	
	90	922			1000		907		991	

## APARTMENT ENTRANCE DOORS

CN	Size	S <sub>s</sub>	H <sub>s</sub>	D <sub>s</sub>	S <sub>o</sub>	H <sub>o</sub>	O <sub>s</sub>	O <sub>w</sub>	S <sub>b</sub>	H <sub>b</sub>	S <sub>z</sub> (6)	S <sub>z</sub> (8)	H <sub>z</sub>	T <sub>s w</sub>
AGAT, OPAL	80	848	1985	40 / 41	880	2010	800	1968***	860	1998	910		2023	±10 / ±5
	90	948			980		900		960		1010			
	100	1048			1080		1000		1060		1110			
KWARC GRANIT KL.C with steel door frame	80	848	1985	44 / 45 48 / 49	880	2010	800	1968***	860	1998	910		2023	±10 / ±5
	90	948			980		900		960		1010			
	100	1048			1080		1000		1060		1110			
EXTREME RC2, EXTREME RC 3 with steel door frame	80	848	1985	50	880	2010	800	1968***	860	1998	910		2023	±10 / ±5
	90	948			980		900		960		1010			
	100	1048			1080		1000		1060		1110			
EXTREME RC 3 with PS door frame	80	848	1985	50	885	2015	806	1971***	854	1995	-	990	-	±10 / ±5
	90	948			985		906		954		-	1090		
	100	1048			1085		1006		1054		-	1190		
EXTREME RC 3 EI45	80	848	1985	58	880	2010	800	1968***	860	1998	910		2023	±10/±5
	90	948			980		900		960		1010			
	100	1048			1080		1000		1060		1110			
EXTREME RC 3 EI60	80	848	1985	62	880	2010	800	1968***	860	1998	910		2023	±10/±5
	90	948			980		900		960		1010			
	100	1048			1080		1000		1060		1110			
Steel SECURE	80	848	1985	54	880	2010	800	1968***	860	1998	910		2023	±10/±5
	90	948			980		900		960		1010			
	100	1048			1080		1000		1060		1110			

\*\* When using the PROJEKT (BIS and Premium) door frame, the wall opening S<sub>o</sub> should be increased by 30 mm and the height H<sub>o</sub> by 15 mm (tolerance ±10 mm / ±5 mm).

**NOTE:** in the case of steel door frames, for the dimensions of wall openings given in the tables, it may be necessary to make small spot chisels on the wall edges in places where the internal elements of the door frames protrude - see the drawing on page

# Contact us



Do you want to buy and install PORTA doors?

Contact us: [export@porta.com.pl](mailto:export@porta.com.pl)



[instagram.com/porta\\_doors/](https://www.instagram.com/porta_doors/)



[facebook.com/portadoors.en](https://www.facebook.com/portadoors.en)



[linkedin.com/company/porta-kmi](https://www.linkedin.com/company/porta-kmi)



[pinterest.co.uk/porta\\_doors/](https://www.pinterest.co.uk/porta_doors/)



**SCAN THE QR CODE  
AND CHECK OUT  
where to buy PORTA doors**

## See PORTA catalogues

### **CATALOGUE 2026** Doors for Houses and Apartments

Download the catalogue  
in PDF format



### **CATALOGUE** **PORTA THERMO** Exterior Steel Doors

Download the catalogue  
in PDF format



### **CATALOGUE 2026** Entrance and Function Doors

Download the catalogue  
in PDF



This catalogue does not constitute a binding offer, assurance or guarantee regarding product characteristics or quality. PORTA KMI Poland S.A. reserves the right to make changes to technical parameters, equipment, prices, warranty terms and product specifications without prior notice. All information contained in this catalogue is valid at the time of publication.

Attention: Due to the printing process, the colours of the products shown may differ from the actual colours.

**Porta KMI Poland S.A. ul. Szkolna 54, 84-239 Bolszewo**

Registered office: Poland, Pomeranian voivodeship, Wejherowo county, Bolszewo

District Court Gdańsk-Północ in Gdańsk, 8th Commercial Division of the National Court Register,

KRS No.: 0000 838 758, NIP: 585 000 62 04 Share capital: PLN 125,704,899, fully paid up.

Print PORTA KAT\_EN\_2026

Date 01.2026

(1) Group Basic durability

(1)

<p><b>Synthetic veneer</b></p>  <p>Andersen Pine    Wenge White    Whitenen Walnut</p>  <p>Classic Oak    Dark Oak</p>	<p><b>Synthetic veneer</b></p>  <p>Norwegian Pine    Silver Acacia    Golden Craft Oak</p>  <p>Mauvella oak    Catania Oak    Honey Acacia</p>  <p>Scarlet Oak</p>	<p><b>Paint / UV Paint</b></p>  <p>White</p> <p><b>Synthetic veneer</b></p>  <p>White    Grey    Fjord    Olive</p>
--	---	---

(2) Group Increased durability

(2)

<p><b>Synthetic veneer</b></p>  <p>Salvador Bleached Oak    Salvador Light Oak    Natural Arles Oak</p>  <p>Toffe Arles Oak    Dark Arles Oak    Havana Oak</p>	<p><b>Synthetic veneer</b></p>  <p>Matte Oak    Natural Oak    California Oak</p>  <p>Dark Matte Oak</p>	<p><b>Synthetic veneer</b></p>  <p>Scandinavian Oak    Light Hickora Jackson    English Oak Hamilton</p>  <p>Siberian Oak    Dark Hickora Jackson</p>	<p><b>Lacquered Veneer Premium UV Paint</b></p>  <p>White</p> <p><b>Soft CPL</b></p>  <p>White    Cashmere</p> <p><b>Soft CPL</b></p>  <p>Grey    Fjord    Olive    Black</p>
---	--	---	--





(3) Group High durability

(3)

<p><b>CPL laminate</b></p>  <p>Vicenza Oak    Grey Vicenza Oak    Bookmatch Oak</p>	<p><b>CPL laminate</b></p>  <p>Light Lakeland Acacia    Lorenzo Oak    Natural Kendal Oak</p>  <p>Natural Hickory    Natural Oak    Natural Walnut</p>	<p><b>CPL laminate</b></p>  <p>Golden Craft Oak</p>	<p><b>Premium Plus UV paint</b></p>  <p>White    Cashmere    Grey    Sage</p> <p><b>CPL laminate</b></p>  <p>White Structure    Grey Euroinvest Structure    Anthracite Structure    Black structure</p>
---	--	--	--

(4) Group Highest durability

(4)

<p><b>3mm Synchronous Board</b></p>  <p>White Casella Oak    Natural Casella Oak    Brown Casella Oak    Casella Marone Oak</p>	<p><b>3mm Synchronous Board</b></p>  <p>Sand Oak</p>	<p><b>3mm Synchronous Board</b></p>  <p>Halifax Natural    Halifax Tabak    Sherman Oak</p>	<p><b>CPL Matte Laminate</b></p>  <p>Cashmere    Sandy Grey    Dusty Grey</p>
---	---	--	--



<b>4 Elements doors</b>	4 Elements AIR	40	
	4 Elements WATER	92	
	4 Elements FIRE	78	
	4 Elements EARTH	68	
<b>Concealed doors</b>	PORTA HIDE	82	
	WALL PANELING	86	
<b>Painted doors</b>	PORTA VECTOR PREMIUM	58, 72, 110, 142, 152	
	PORTA ART DECO	90	
	PORTA OSLO	140	
	PORTA FOCUS PREMIUM	156	
	PORTA DESIRE	104	
	PORTA GRANDE	34, 112	
	PORTA VERRO	50	
	PORTA IMPERIAL	36	
	PORTA ORNATO	38	
	PORTA FACTOR	58, 74, 110	
	PORTA ROYAL	60	
	LONDON, VIENNA	62	
	<b>Loft style doors</b>	PORTA GLASS	168
PORTA LUMIA		166	
PORTA LOFT STEEL		164	
<b>Veneered frame and panel doors</b>	PORTA BALANCE	42, 128	
	PORTA HARMONY	32	
	PORTA INSPIRE	54, 118	
	PORTA CONCEPT, g A, VERTE PREMIUM, g D	120	
	PORTA KONCEPT, g C and H	124	
	PORTA CONCEPT, g K, VERTE PREMIUM, g A	126	
	PORTA VERTE PREMIUM, g E	114	
	PORTA VERTE HOME, g B	122	
	PORTA VERTE HOME, g E and M	146	
	PORTA VERTE HOME, g C	134	
	PORTA VERTE HOME, g D	132	
	PORTA VERTE HOME, g Gz	116	
	PORTA VERTE HOME, g H and J	130	
	PORTA VERTE HOME, g L	136	
	PORTA VERTE HOME, g N	128	
	PORTA CLASSIC HOME	44	
	PORTA CRAFT	148	
	<b>Veneered flush doors</b>	PORTA RESIST	76, 108, 154, 160
		PORTA FOCUS	158
PORTA LOFT		78, 160	
PORTA LEVEL		70	
PORTA LEVEL LINE		102	
PORTA VIGO		144	
PORTA NOVA		56	
PORTA FIT		134, 136	
PORTA LINE		100, 108, 154	
PORTA CPL		76	
PORTA DECOR		76	
TRIM, TRIM SOFT, TRIM LITE		26	
<b>Doors finished with natural veneer</b>		NATURE CLASSIC	66
		NATURA VERDINO	68, 94, 98
	NATURE VECTOR	142, 152	
	NATURE LINE	100, 108, 154	
	NATURE OSLO	140	
	NATURE GRANDE	34, 112	
	NATURE SPACE	156	
	SEVILLE	52	
MADRID, CORDOBA	48		



# PORTA

NEW  
/ FIRST  
ON THE  
MARKET

# 100% WATERPROOF



**DOOR FRAME  
HYDRO PROTECT™**

**FUNCTION  
+ DESIGN**

**No more swollen door frames in wet rooms!**

**HYDRO PROTECT™** The new generation of PORTA SYSTEM door frames, made of wood-polymer composite, which allows you to feel comfortable and safe in the kitchen, bathroom, laundry room, and anywhere else where surfaces are particularly exposed to humidity. Enjoy life and peace of mind – the **HYDRO PROTECT™** door frame is 100% waterproof. Discover the new quality of door frames on pages 8-9, 209, 214-215 or look for the **Hydro Protect™** icon next to products in the catalogue.